

---

Option 11 & Meridian 1

# Intelligent Peripheral Equipment Circuit Cards for Asia Pacific

## Description and installation

---

P0 Number: P0875863

Document Release: Standard 2.00

Date: October 1997

---

© 1996, 1997

All rights reserved

Printed in Canada

Information is subject to change without notice. Northern Telecom reserves the right to make changes in design or components as progress in engineering and manufacturing may warrant. This equipment has been tested and found to comply with the limits for a Class A digital device pursuant to Part 15 of the FCC rules, and the radio interference regulations of Industry Canada. These limits are designed to provide reasonable protection against harmful interference when the equipment is operated in a commercial environment. This equipment generates, uses and can radiate radio frequency energy, and if not installed and used in accordance with the instruction manual, may cause harmful interference to radio communications. Operation of this equipment in a residential area is likely to cause harmful interference in which case the user will be required to correct the interference at their own expense.

SL-1 and Meridian 1 are trademarks of Northern Telecom.

## Revision history

---

**October 1997**

Issue 2.00 released as Standard for Generic X11 Release 23.0x.

**August 1996**

Issue 1.00 released as Standard.

---

# Contents

---

<b>About this document</b> .....	<b>xix</b>
<b>Enhanced Extended Universal Trunk Cards for Asia Pacific</b> .....	<b>1</b>
Overview .....	1
Physical description .....	3
Functional description .....	5
Card interfaces .....	5
Card functions .....	9
Unit configuration .....	12
Jumper strap settings .....	12
Service change entries .....	12
Port-to-port loss configuration .....	16
Electrical specifications .....	17
Environmental specifications .....	18
Foreign and surge voltage protection .....	18
Operation .....	19
Loop start operation .....	19
Incoming calls .....	19
Outgoing calls .....	19
Far end release .....	20
Busy Tone Disconnect Supervision .....	25
Trunk configuration for Loop start operation .....	26
Ground start operation .....	28
Incoming calls .....	28

Outgoing calls .....	29
Direct inward dial operation .....	34
Incoming calls .....	34
Two-way, Loop Dial Repeating, TIE trunk operation .....	36
Incoming calls .....	36
Outgoing calls .....	38
Senderized operation for DID and two-way loop DR trunks .....	40
Incoming calls .....	40
Outgoing calls .....	40
Outgoing automatic, incoming dial operation .....	43
Incoming calls .....	43
Outgoing calls .....	43
Recorded announcement trunk operation .....	48
Recorded announcement machines .....	49
RAN modes of operation .....	49
Call routing to RAN trunks .....	52
Programming RAN trunks .....	52
Paging trunk operation .....	53
Music operation .....	54
<b>Digital Signal Processing Extended</b>	
<b>Universal Trunk Card .....</b>	<b>55</b>
Overview .....	55
Physical description .....	58
Functional description .....	60
Card interfaces .....	60
Card functions .....	64
Unit configuration .....	67
Jumper strap settings .....	67
Service change entries .....	67
Port-to-port loss configuration .....	72
Electrical specifications .....	73
Environmental specifications .....	74

---

Foreign and surge voltage protection .....	74
Operation .....	75
Loop start operation .....	75
Incoming calls .....	75
Outgoing calls .....	75
Far end release .....	76
Busy Tone Detection .....	81
International busy tone characteristics for reference .....	82
Trunk configuration for loop start operation .....	85
Ground start operation .....	88
Incoming calls .....	88
Outgoing calls .....	89
Direct Inward Dial operation .....	94
Incoming calls .....	94
Two-way, Loop Dial Repeating, TIE trunk operation .....	96
Incoming calls .....	96
Outgoing calls .....	98
Senderized operation for DID and two-way loop DR trunks .....	100
Incoming calls .....	100
Outgoing calls .....	100
Outgoing automatic, incoming dial operation .....	103
Incoming calls .....	103
Outgoing calls .....	103
Recorded announcement trunk operation .....	108
Recorded Announcement machines .....	109
RAN modes of operation .....	109
Call routing to RAN trunks .....	112
Programming RAN trunks .....	112
Paging trunk operation .....	113
Music operation .....	114
<b>Busy Tone Detection for Asia Pacific and CALA .....</b>	<b>115</b>
Operating parameters .....	116

Feature interactions .....	118
Feature packaging .....	118
Feature implementation .....	118
Feature operation .....	121

## About this document

---

This document describes the functions and applications of the following circuit cards that are available for use in Asia Pacific:

- NT5D26AA Enhanced Extended Universal Trunk card with 400 Hz Busy Tone Disconnect feature
- NT5D26BA Enhanced Extended Universal Trunk card with 425 Hz Busy Tone Disconnect feature
- NT5D31AA Digital Signal Processing Extended Universal Trunk Card

The Busy Tone Detection for Asia Pacific and CALA feature was added to this guide for X11 Release 23.

---

# Enhanced Extended Universal Trunk Cards for Asia Pacific

---

## Overview

The NT5D26AA and the NT5D26BA Enhanced Extended Universal Trunk Cards for Asia Pacific (EXUTAP-1 and EXUTAP-2, respectively) are Intelligent Peripheral Equipment (IPE) circuit cards which may be installed in either the NT8D37 IPE Module or the NT8D11 CE/PE Module. These EXUTAP cards provide the interface between eight trunks and the Meridian 1 system. Each trunk interface is independently configurable by software control in the Trunk Administration program (LD 14).

These two cards, the NT5D26AA EXUTAP-1 and the NT5D26BA EXUTAP-2, are identical except for the Busy Tone Disconnect Supervision feature for COT Loop Start mode. The NT5D26AA EXUTAP-1 card provides Busy Tone Disconnect Supervision with a frequency bandwidth of  $400\pm 25$  Hz for use in Thailand, while the NT5D26BA EXUTAP-2 card provides Busy Tone Disconnect Supervision with a frequency bandwidth of  $425\pm 25$  Hz for use in Indonesia, Malaysia, and Singapore. The minimum level of Busy Tone required for disconnect supervision is -25 dBm.

The NT5D26AA EXUTAP-1 and the NT5D26BA EXUTAP-2 cards support the following trunk types:

- Central Office (CO), Foreign Exchange (FX), and Wide Area Telephone Service (WATS) trunks
- Central Office Loop start signaling with Busy Tone Disconnect Supervision
- Direct Inward Dial (DID) trunks



- TIE trunks: two-way Loop Dial-Repeating (LDR) and two-way loop Outgoing Automatic Incoming Dial (OAID)
- Recorded Announcement (RAN) trunks
- Paging trunks (PAGT)
- Outgoing Automatic Number Identification (OANI)

The NT5D26AA EXUTAP-1 and NT5D26BA EXUTAP-2 Universal Trunk cards also support music, automatic wake up, and Direct Inward System Access (DISA) features.

Table 1 is a matrix of the signaling and trunk types supported by the NT5D26AA EXUTAP-1 and the NT5D26BA EXUTAP-2 cards.

**Table 1**  
**Trunk and signaling matrix**

Signaling type	Trunk types				
	CO/FX/WATS	DID	TIE	RAN	Paging
Loop start	Yes	No (see note)	No	N/A	N/A
Ground start	Yes	No	No	N/A	N/A
Loop DR	No	Yes	Yes	N/A	N/A
Loop OAID	No	No	Yes	N/A	N/A
Continuous operation mode	No	No	No	Yes	N/A
Start modes (pulse and level)	No	No	No	Yes	N/A
<b>Note:</b> For incoming and outgoing service, DID trunks must be programmed as Loop Dial Repeating (LDR).					

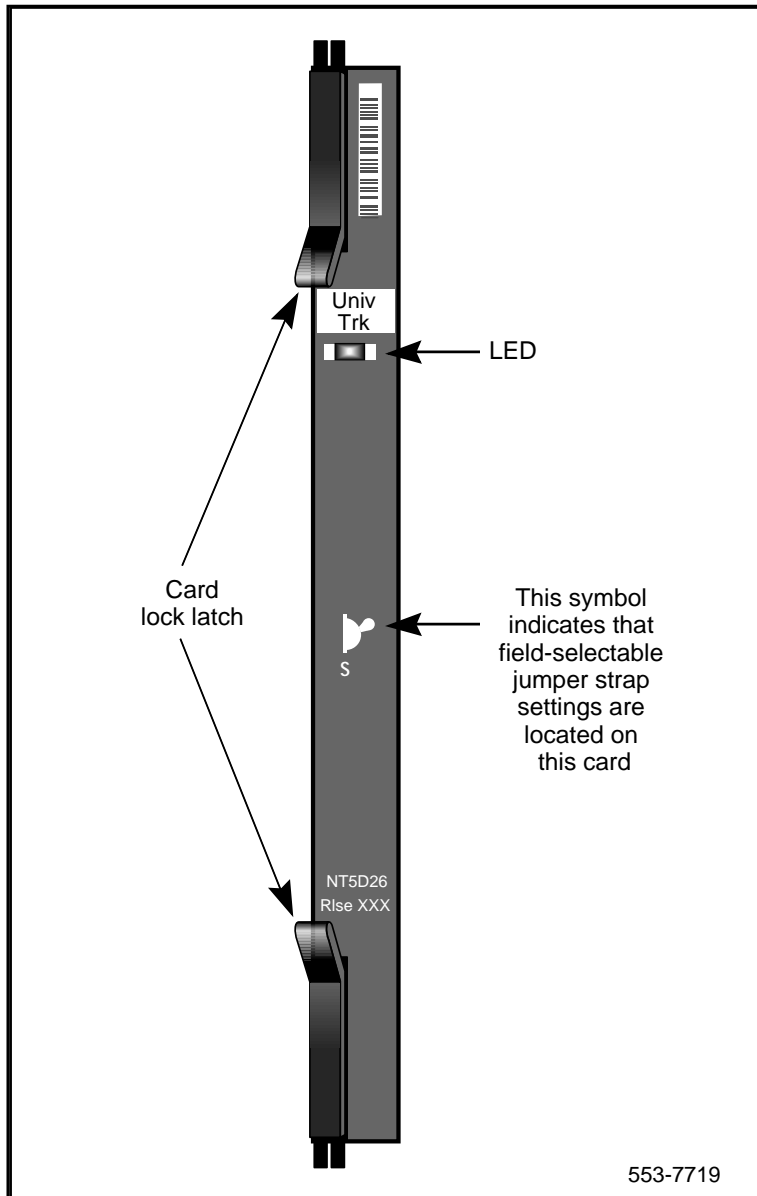
## Physical description

The NT5D26AA EXUTAP-1 and NT5D26BA EXUTAP-2 cards mount in any IPE slot. The trunk and common multiplexing circuitry for each card is mounted on a 31.75 by 25.40 cm (12.5 by 10 in.) printed circuit board.

The NT5D26AA and NT5D26BA EXUTAP cards connect to the backplane through a 160-pin connector shroud. The backplane is cabled to the input/output (I/O) panel, which is cabled to the main distribution frame (MDF) by 25-pair cables. External equipment, such as Recorded Announcement machines, Paging equipment, and Central Office facilities, connect to the cards at the MDF. See *Meridian 1 system installation procedures* for termination and cross-connect information.

The faceplate of the card is equipped with a red, light-emitting diode (LED) (see Figure 1). When a EXUTAP card is installed, the LED remains lit for two to five seconds while the self-test runs. If the self-test completes successfully, the LED flashes three times and remains lit until the card is configured and enabled in software, then the LED goes out. If the LED does not follow this pattern or operates in any other manner, such as continually flashing or remaining weakly lit, the card should be replaced.

**Figure 1**  
**NT5D26 EXUTAP-1 and EXUTAP-2 Universal Trunk card—faceplate**



## Functional description

This functional description of the NT5D26AA EXUTAP-1 and the NT5D26BA EXUTAP-2 cards is divided into two parts. First, a description of the cards' control, signaling, and power interfaces is given, followed by a description of how the cards function.

### Card interfaces

Figure 2 shows the position of the NT5D26AA and NT5D26BA EXUTAP cards within the Meridian 1 system architecture.

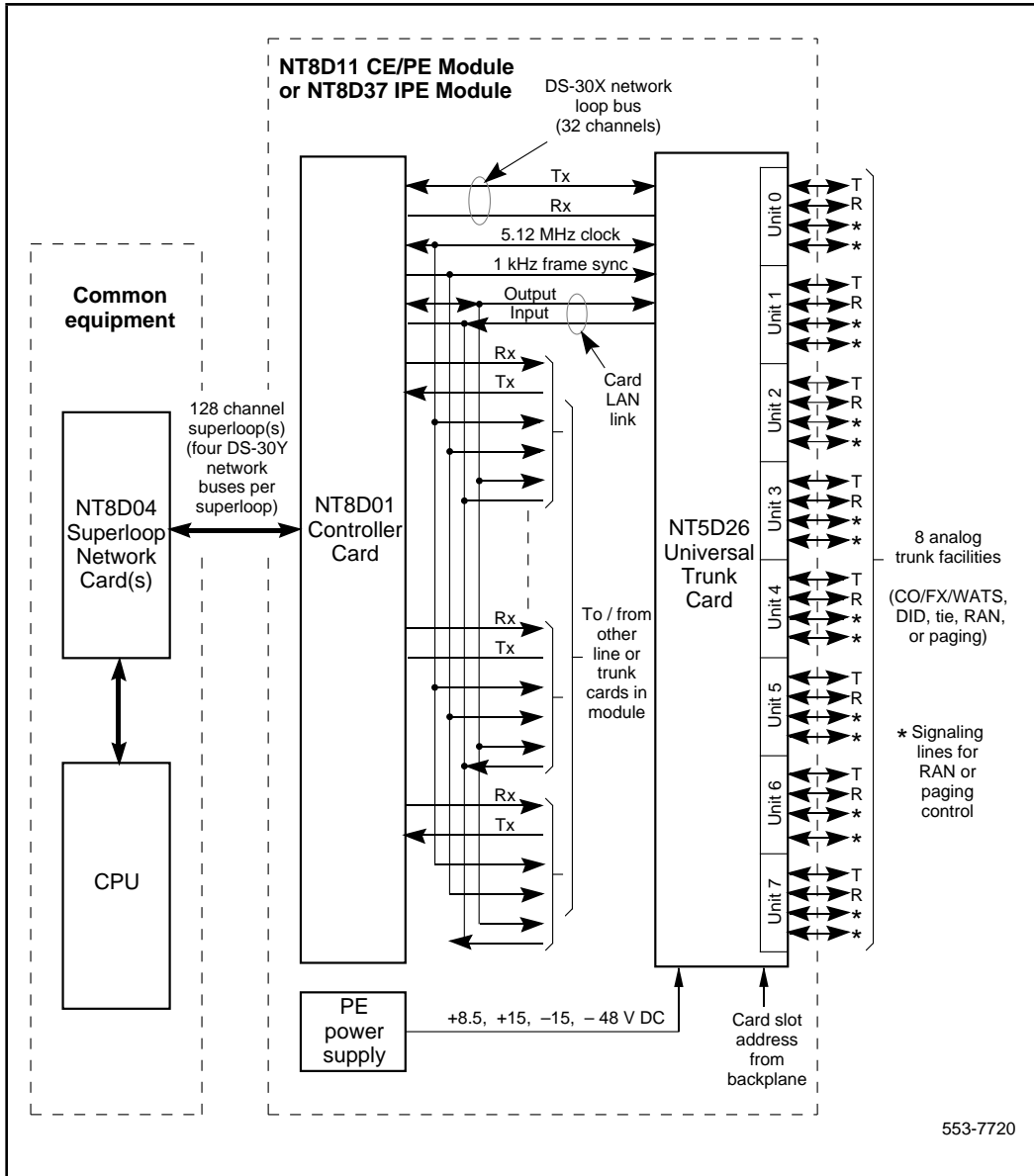
#### Voice and signaling interfaces

The eight trunk interfaces provided by the Universal Trunk card connect to conventional, 2-wire (tip and ring) analog trunk facilities. Incoming analog voice and signaling information from a trunk facility is converted by the EXUTAP card to digital form and routed to the Meridian 1 common equipment (CE) CPU over DS-30 network loops. Conversely, digital voice and signaling information from the CPU is sent over DS-30 network loops to the EXUTAP card where it is converted to analog form and applied to the trunk facility.

A separate, dedicated, DS-30X network loop is extended between each IPE line/trunk card and the controller card within an IPE module (or IPE section of a CE/PE module). A DS-30X network loop is composed of two, synchronous, serial data buses. Each bus has a capacity of 32 channels but only 30 are used for Pulse Code Modulated (PCM) voice data. One bus transports in the transmit (Tx) direction towards the trunk facility and the other in the receive (Rx) direction towards Meridian 1 CE. Each channel contains ten bits. Eight bits are for PCM data and two are call signaling bits.

The eight-bit PCM portion of a channel is called a *timeslot*. The DS-30X loop is clocked at 2.56 Mbps, one-half the 5.12 MHz clock frequency supplied by the controller card. Thus, the timeslot repetition rate for a single channel is 8 kHz. The controller card also supplies a 1 kHz frame sync signal for channel synchronization. The EXUTAP card uses only eight of the 30 available timeslots for its eight trunk interfaces. The card can be configured in software to format PCM data in the  $\mu$ -law or A-law conventions.

**Figure 2**  
**NT5D26 EXUTAP-1 and EXUTAP-2 Universal Trunk card—system interface**



DS-30Y network loops extend between controller cards and superloop network cards in the CE and function in a manner similar to DS-30X loops. Essentially, a DS-30Y loop carries the PCM timeslot traffic of a DS-30X loop. Four DS-30Y network loops form a *superloop* with a capacity of 128 channels (120 usable timeslots). Various superloop configurations exist. See Meridian 1 *Meridian 1 system engineering* for more information on superloops.

When the NT5D26AA EXUTAP-1 or the NT5D26BA EXUTAP-2 card is used as an interface to RAN or Paging equipment, additional control lines are provided. For RAN equipment, these lines provide for synchronization of Meridian 1 switching to the playing of recorded announcements. For Paging equipment, the control lines provide for keying of paging amplifiers.

### **Maintenance communications**

Maintenance communications are control and status data that is exchanged between line or trunk cards and the CE CPU by way of the controller card. Maintenance data is transported via the *card LAN* link. This link is composed of two, asynchronous serial buses. Each bus is common to all line/trunk card slots in the IPE module (or IPE section of a CE/PE module) and is arranged in a master/slave configuration. The controller card is the master and all other cards are slaves. The module backplane provides each line/trunk card slot with a unique, hardwired, slot address. A slot address enables a slave card to respond when addressed by the controller card. The controller card communicates with only one slave at a time. One bus is used for output of control data and the other is used for input of status data.

In normal operation, the controller card continually scans (polls) all slave cards connected to the card LAN to monitor their presence and operational status. The slave card sends replies to the controller on the input bus along with its card slot address for identification. In this reply, the slave informs the controller if any change in card status has taken place. The controller can then prompt the slave for specific information. Slaves only respond when prompted by the controller; they do not initiate exchange of control or status data on their own. When the EXUTAP card is first plugged into the backplane, it runs a self test. When the self test is completed, a properly functioning card will respond to the next controller card poll with the self-test status. The controller will then query for card identification and other status information.

The card LAN link supports the following functions on the EXUTAP-1 and EXUTAP-2 cards:

- polling
- reporting of self-test status
- CPU initiated card reset
- reporting of card ID (card type and hardware vintage)
- reporting of firmware version
- downloading trunk interface unit configuration
- reporting of trunk interface unit configuration
- enabling/disabling of the DS-30X network loop bus
- reporting of card status

**Power requirements**

Power to the NT5D26AA EXUTAP-1 and the NT5D26BA EXUTAP-2 cards is provided by the module power supply (AC or DC). Table 2 lists the power requirements for these cards.

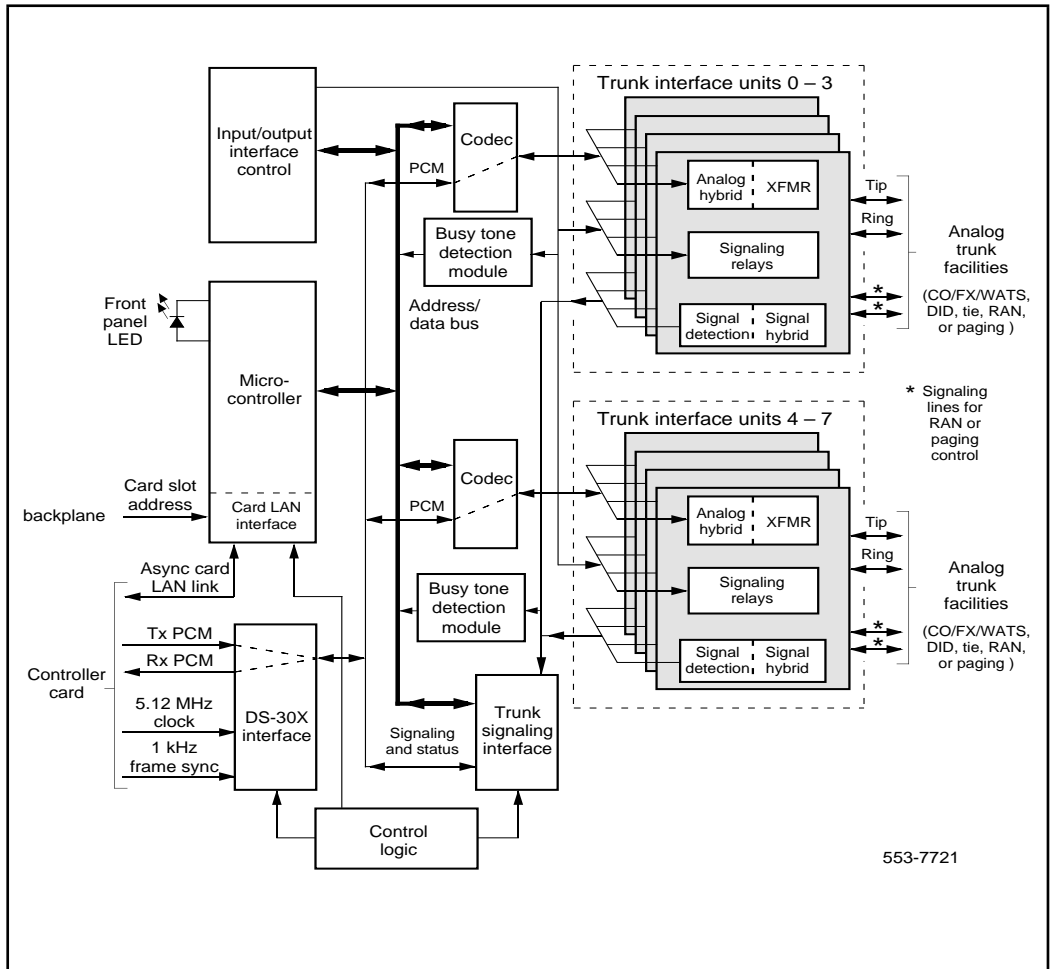
**Table 2**  
**Power requirements**

Voltage	Tolerance	Current (max.)
+15.0 V dc	±5%	350 mA
+ 8.5 V dc	±2%	450 mA
- 48.0 V dc	±5%	415 mA

### Card functions

Figure 3 shows a block diagram of the major functions contained on the NT5D26AA EXUTAP-1 and NT5D26BA EXUTAP-2 Universal Trunk cards.

**Figure 3**  
**NT5D26 EXUTAP-1 and EXUTAP-2 Universal Trunk card—block diagram**





### **Trunk interface units**

The NT5D26AA EXUTAP-1 and the NT5D26BA EXUTAP-2 cards contain eight identical and independently configurable trunk interface units (also referred to as circuits). Each unit provides impedance matching and a balance network in a signal transformer/analog hybrid circuit. Also provided are relays for placing outgoing call signaling onto the trunk. Signal detection circuits monitor incoming call signaling. Two codecs are provided for performing A/D and D/A conversion of trunk analog voiceband signals to digital PCM signals. Each codec supports four trunk interface units. The following features are common to all units on the cards:

- trunk type configurable on a per unit basis
- Terminating Impedance (600 or 900 ohm) selectable on a per unit basis
- Balance Impedance (600 or 900 ohm or complex impedance network - 3COM) selectable on a per unit basis. In addition, 3CM2 Balance Impedance option is provided for loaded cables.
- control signals provided for RAN and Paging equipment
- loopback of PCM signals received from trunk facility over DS-30X network loop for diagnostic purposes
- switchable pads for transmission loss control

### **Card control functions**

Control functions are provided by a microcontroller, a card LAN interface, and signaling and control circuits on the NT5D26AA EXUTAP-1 and the NT5D26BA EXUTAP-2.

**Microcontroller** - These cards contain a microcontroller that controls the internal operation of the card and the serial card LAN link to the controller card. The microcontroller controls the following:

- reporting to the CE CPU via the card LAN link:
  - card identification (card type, vintage, and serial number)
  - firmware version
  - self-test status
  - programmed configuration status

- receipt and implementation of card configuration via the card LAN link:
  - programming of the codecs
  - enabling/disabling of individual units or entire card
  - programming of input/output interface control circuits for administration of trunk interface unit operation
  - maintenance diagnostics
  - transmission pad settings

**Signaling and control** - The signaling and control portion of each card provides circuits that establish, supervise, and take down call connections. These circuits work with the system CPU to operate trunk interface circuits during calls. The circuits receive outgoing call signaling messages from the CPU and return incoming call status information over the DS-30X network loop.

## Unit configuration

The trunk type for each unit on the cards, as well as its terminating impedance and balance network configuration, is selected by software service change entries at the system terminal and by jumper strap settings on the cards.

### Jumper strap settings

For most applications, the jumper strap settings remain set to the standard configuration as shipped from the factory as described in Table 3.

For CO/FX/WATS or TIE trunk loops exceeding 762 meters (2500 ft), DID trunks exceeding a loop resistance of 600 ohms, or RAN trunks operating in pulse start or level start modes, the jumper strap settings must be changed as shown in Table 4. Figure 4 shows jumper locations on the EXUTAP cards.

In the rare case where loaded cable is used in the facility, 3CM2 balance termination is recommended and the jumper strap J4.X should be set to position 2-3. Software setup in LD 14 is also required.

*Note:* Refer to *Circuit card installation and testing* for further information regarding jumper strap settings.

### Service change entries

Trunk type, terminating impedance, and balance network are selected by service change entries in the Trunk Administration program (LD 14). Refer to Table 5 to select the proper values for the trunk type and loop length being employed. Refer to the Meridian 1 *X11 input/output guide* for LD 14 service change instructions.

Before the appropriate balance network can be selected, the loop length between the near end (Meridian 1) and the far end (a Central Office, for example) must be known. To assist in determining loop length, some typical resistance and loss values for the most common cable lengths are given in Table 6 for comparison with values obtained from actual measurements.

**Table 3**  
**Jumper strap settings—factory standard (NT5D26AA and NT5D26BA)**

Trunk types	Loop length/ Resistance	Jumper strap settings			
		J1.X	J2.X	J3.X	J4.X
CO/FX/WATS	Zero – 762 m (2500 ft)	Off	Off	1-2	1-2
2-way TIE (LDR)					
2-way TIE (OAID)					
DID	Zero – 600 Ω				
RAN: continuous operation mode					
Paging					

**Note:** Jumper strap settings J1.X, J2.X, J3.X, and J4.X apply to all eight units; “X” indicates the unit number, 0–7. “Off” indicates that no jumper strap is installed on a jumper block. Store unused straps on the Universal Trunk card by installing them on a single jumper pin as shown below:

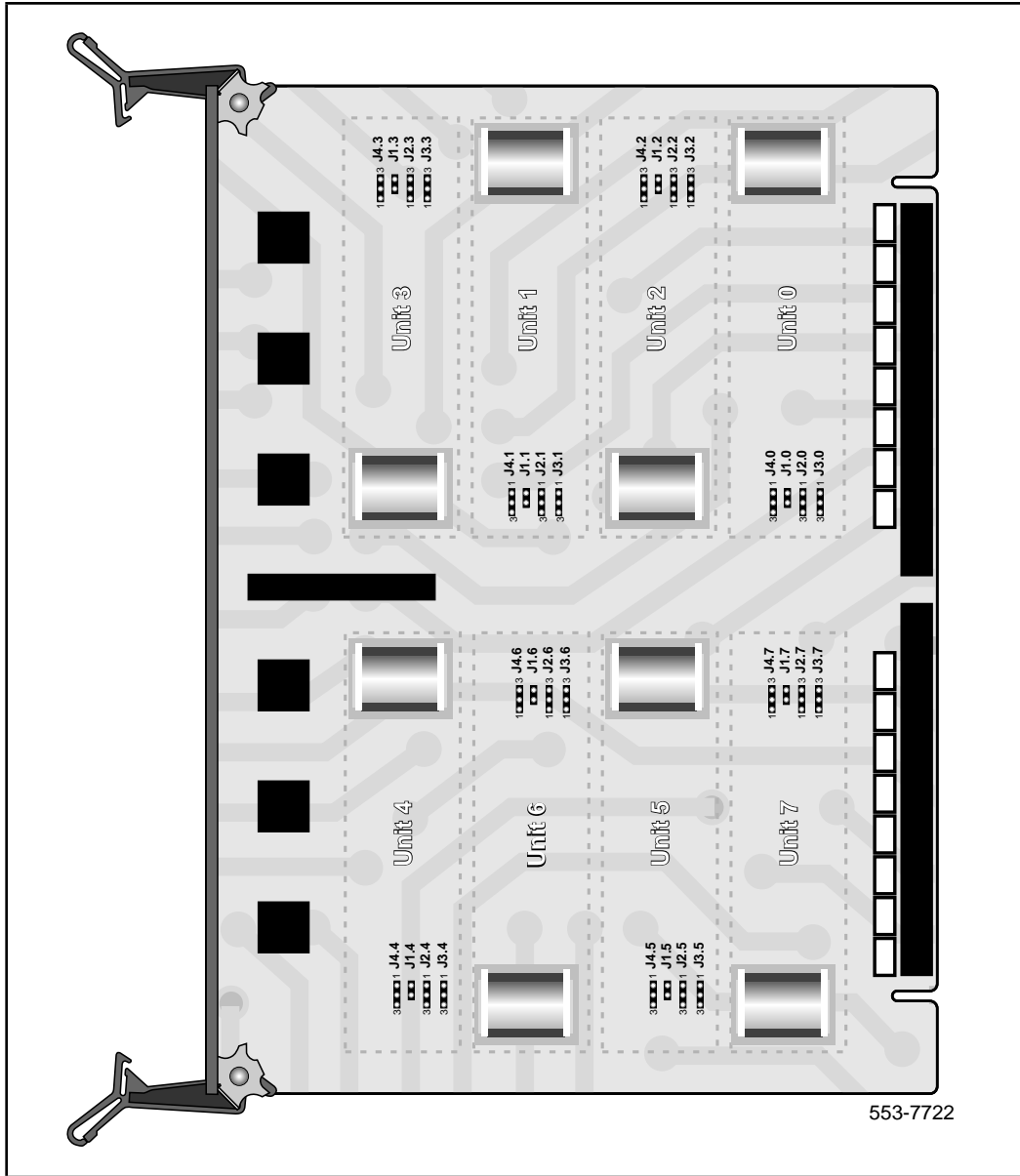
553-5924

**Table 4**  
**Jumper strap settings—extended range (NT5D26AA and NT5D26BA)**

Trunk types	Loop length/ Resistance	Jumper strap settings							
		J1.X	J2.X	J3.X	J4.X				
CO/FX/WATS	> 762 m (2500 ft)	Off	Off	1-2	1-2				
2-way TIE (LDR)									
2-way TIE (OAID)									
DID	> 600 Ω					On	On	1-2	1-2
RAN: pulse start or level start modes						Off	Off	2-3	1-2

**Note:** Jumper strap settings J1.X, J2.X, J3.X, and J4.X apply to all eight units; “X” indicates the unit number, 0–7. “Off” indicates that no jumper strap is installed on a jumper block

Figure 4  
Jumper locations (NT5D26AA and NT5D26BA)



**Table 5**  
**Trunk types—termination impedance and balance network (NT5D26AA and NT5D26BA)**

Trunk types	Terminating impedance (Note 1)	Balance network for loop lengths (Note 2)		
		Zero –762 m (zero – 2500ft)	> 762 m (>2500 ft)	For Loaded Cable
CO/FX/WATS	600 $\Omega$	600 $\Omega$	3COM	3CM2
2-way TIE (LDR)	600 $\Omega$	600 $\Omega$	3COM	3CM2
2-way TIE (OAID)	600 $\Omega$	600 $\Omega$	3COM	3CM2
DID (loop < 600 $\Omega$ )	600 $\Omega$	600 $\Omega$	3COM	3CM2
DID (loop $\geq$ 600 $\Omega$ )	600 $\Omega$	600 $\Omega$	3COM	3CM2
RAN: continuous operation mode	600 $\Omega$ or 900 $\Omega$	600 $\Omega$ or 900 $\Omega$	N/A	N/A
Paging	600 $\Omega$	600 $\Omega$	N/A	N/A

**Note 1:** The terminating impedance of each trunk unit is software selectable in LD 14 and should match the nominal impedance of the connecting equipment.

**Note 2:** The balance network of each trunk unit is software selectable between resistive 600 or 900  $\Omega$  or 3COM. 3COM and 3CM2 balance network options are provided by jumper setting (J4.X). See Table 4.

**Table 6**  
**Cable loop resistance and loss**

Cable length	Cable loop resistance (ohms)			Cable loop loss (dB) (non-loaded at 1kHz)		
	22 AWG	24 AWG	26 AWG	22 AWG	24 AWG	26 AWG
915 m (3000 ft)	97	155	251	0.9	1.2	1.5
1524 m (5000 ft)	162	260	417	1.6	2.0	2.5
2225 m (7300 ft)	236	378	609	2.3	3.0	3.7
3566 m (11700 ft)	379	607	977	3.7	4.8	6.0
5639 m (18500 ft)	600	960	1544	5.9	7.6	9.4

## Port-to-port loss configuration

The NT5D26AA EXUTAP-1 and the NT5D26BA EXUTAP-2 provide pad switching for control of end-to-end connection loss. Control of loss is a major element in controlling transmission performance parameters such as received volume, echo, noise, and crosstalk.

The transmission properties of each trunk unit are characterized by the Class of Service (CLS) assigned in the Trunk Administration program (LD 14) and the far-end port type (PTY) in the Trunk Route Administration program (LD 16). A complete loss plan is given in *Summary of transmission parameters* where the appropriate port-to-port electrical loss may be determined for connections between any two Meridian 1 ports (lines, analog trunks, or digital trunks).

## Electrical specifications

Table 7 gives the electrical characteristics of the EXUTAP cards.

**Table 7**  
**Electrical characteristics for the NT5D26AA and NT5D28BA**

Characteristic	CO/FX/WATS trunks	DID or TIE trunks	RAN trunks	Paging trunks
Terminal impedance	600 $\Omega$ or 900 $\Omega$ (Note 1)		600 $\Omega$ /900 $\Omega$ (Note 1)	600 $\Omega$
Balance impedance	600 $\Omega$ or 900 $\Omega$ (Note 1), 3COM, or 3CM2 (Note 2)		N/A	N/A
Supervision type	Ground or loop start (with BT sup) (Note 3)	Loop start	Continuous, level, or pulse	N/A
DC signaling loop length (max)	1700 $\Omega$ loop with near-end battery of -42.75 V	2450 $\Omega$ loop with near-end battery of -44 V	600 $\Omega$ /900 $\Omega$ loop	600 $\Omega$ loop
Far-end battery	-42 to -52.5 V (Note 4)	-42 to -52.5 V	-42 to -52 V	N/A
Minimum detected loop current	20 mA	10 mA	10 mA	N/A
Ground potential difference	$\pm 3$ V		$\pm 1$ V	$\pm 1$ V
Low DC loop resistance during outpulsing	<300 $\Omega$	N/A	N/A	N/A
High DC loop resistance	Ground start $\geq 30$ K $\Omega$ ; loop start $\geq 5$ M $\Omega$	N/A	N/A	N/A
Ring detection	17 to 33 Hz 40 to 120 V rms	N/A	N/A	N/A
Line leakage	$\geq 30$ K $\Omega$ , tip-to-ring, tip-to-ground, ring-to-ground		N/A	N/A
AC induction rejection	10 V rms, tip-to-ring, tip-to-ground, ring-to-ground		N/A	N/A
<p><b>Note 1:</b> Selected in software.</p> <p><b>Note 2:</b> Selected by jumper strap settings on card.</p> <p><b>Note 3:</b> Loop start with Busy Tone Disconnect Supervision introduced with minimum Release 21 software.</p> <p><b>Note 4:</b> For loop extender application, the maximum voltage applied between tip and ring is -105 V <math>\pm 5\%</math>. The minimum DC loop resistance for this type of application is 1800 <math>\Omega</math>.</p>				



## Environmental specifications

Table 8 lists the environmental specifications for the EXUTAP cards.

**Table 8**  
**Environmental specifications for the NT5D26AA and NT5D26BA**

Parameter	Specifications
Operating temperature	0° to +60° C (+32 to +140° F), ambient
Operating humidity	5 to 95% RH (non-condensing)
Storage temperature	-40° to +70° C (-40° to +158° F)

## Foreign and surge voltage protection

The NT5D26AA EXUTAP-1 and the NT5D26BA EXUTAP-2 meet UL-1489 and CS03 over-voltage (power cross) specifications and FCC Part 68 requirements.

## Operation

The optional applications, features, and signaling arrangements for each unit on the NT5D26AA and NT5D26BA EXUTAP cards are assigned through the Trunk Administration (LD 14) and Trunk Route Administration (LD 16) programs and/or jumper strap settings on the cards. See the *X11 input/output guide* for detailed information on assigning features and services to trunks.

COT Loop start signaling requires that Busy Tone Detection be configured in software LD 97 prior to the configuration of overlays 16 and 14.

## Loop start operation

Loop start operation is configured in software and is implemented in the card through software download messages. When the EXUTAP card is idle, it provides a high impedance toward the CO for isolation and AC (ringing) detection.

### Incoming calls

The CO sends an alerting signal of 20 Hz (nominal) to the Meridian 1 system. Ringing is tripped when this trunk circuit places a low resistance DC loop towards the CO when an attendant is available. Figures 5 and 6 illustrate this process.

### Outgoing calls

For outgoing calls from the Meridian 1, software sends an outgoing seizure message to place a low-resistance loop across the tip and ring leads towards the CO (see Figures 7 and 8). When the CO detects the low-resistance loop, it prepares to receive digits. When the CO is ready to receive digits, it returns dial tone. Outward address signaling is then applied from the Meridian 1 in the form of loop (interrupting) dial pulses or DTMF tones.

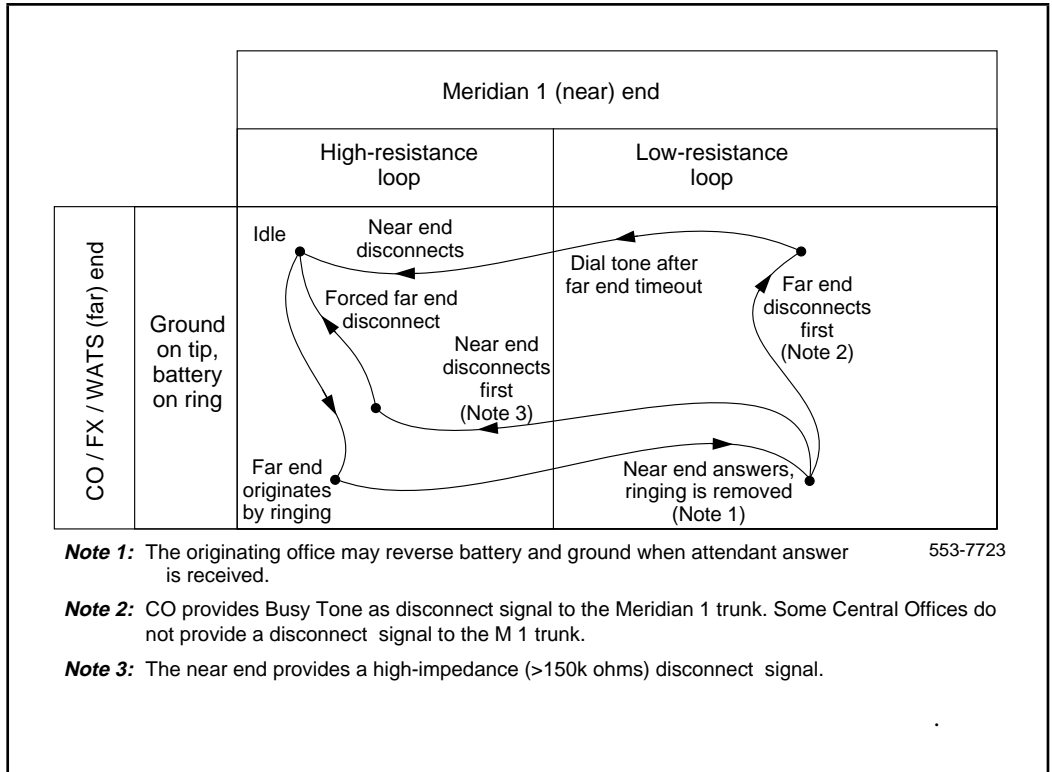
### **Polarity-sensitive/-insensitive packs feature**

The Meridian 1 software provides the “polarity-sensitive/-insensitive packs” (PSP and PIP) feature for the accurate recording of outgoing call duration for loop start and ground start operation. On trunks equipped with far-end answer supervision, the PSP class of service is enabled in software and causes call-duration recording in CDR records to begin only upon receipt of answer supervision from the far end. For trunks not equipped with answer supervision, the PIP Class of Service is enabled and call-duration recording begins immediately upon near-end trunk seizure. The PSP and PIP classes of service are enabled in the Trunk Administration program (LD 14).

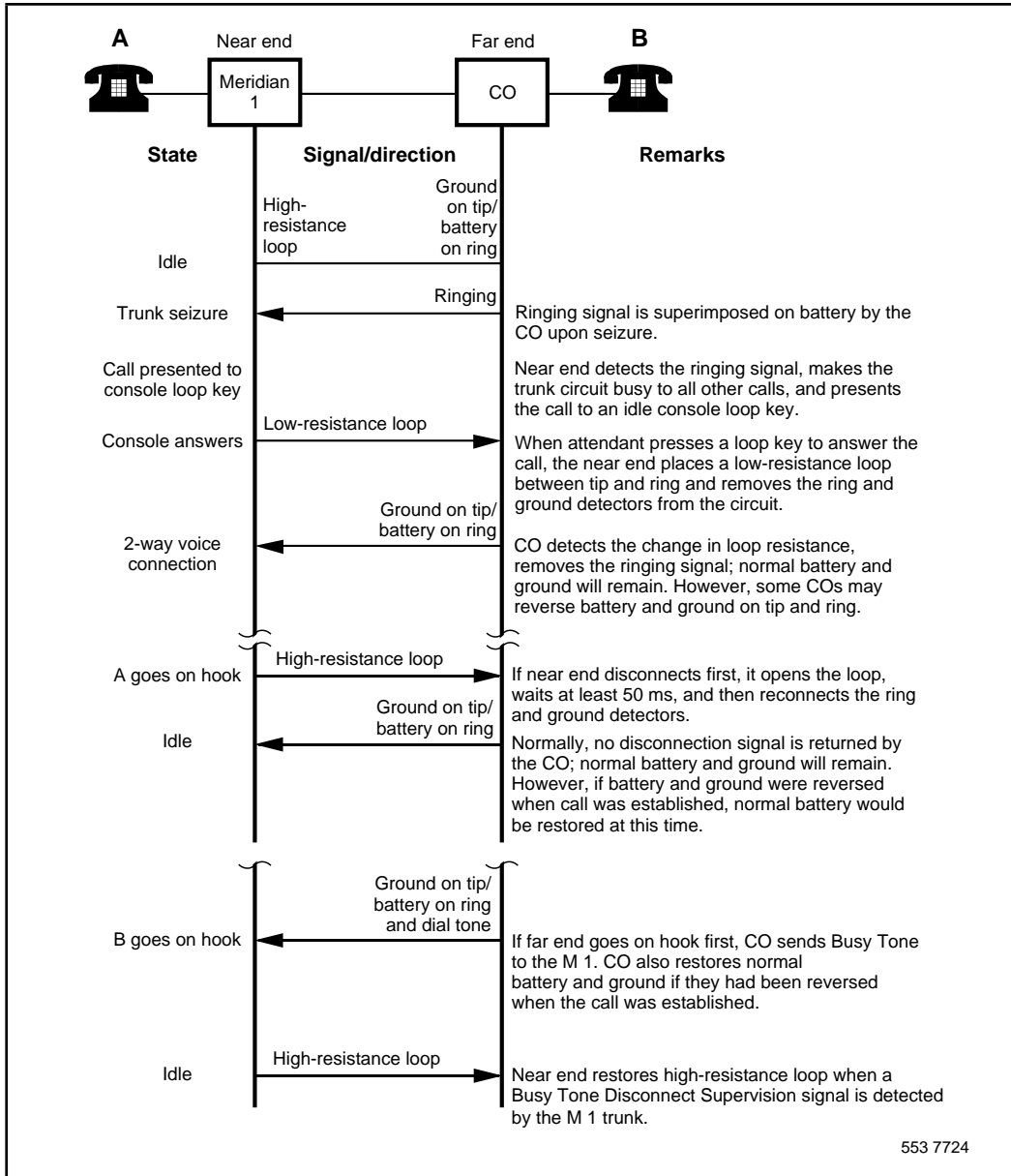
### **Far end release**

If Busy Tone Disconnect Supervision is configured, upon receipt of a Busy Tone signal from the far end the EXUTAP trunk will send a Busy Tone detected message to software. The software will then send a disconnect message to idle the trunk.

**Figure 5**  
**Loop start call states—incoming call from CO/FX/WATS**

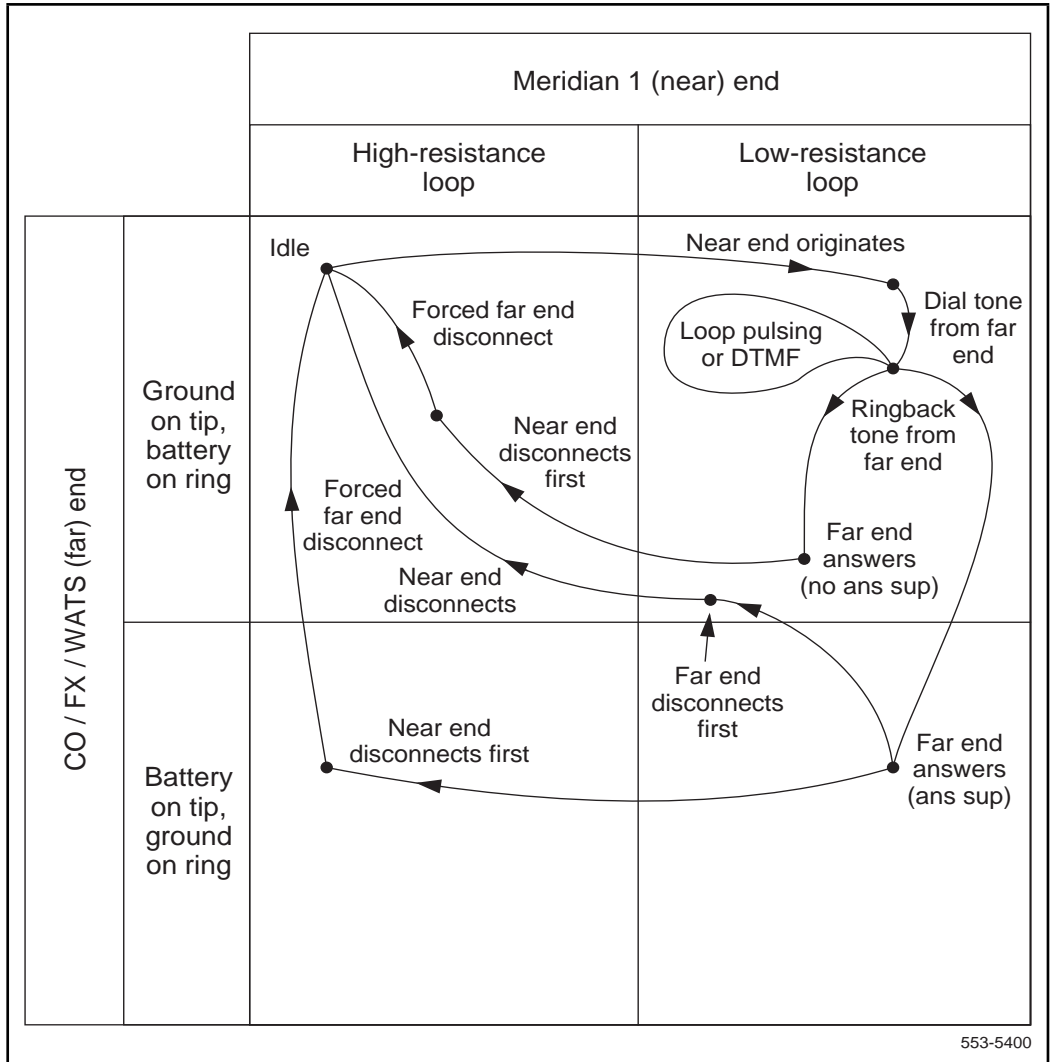


**Figure 6**  
**Loop start call connection sequence—incoming call from CO/FX/WATS**

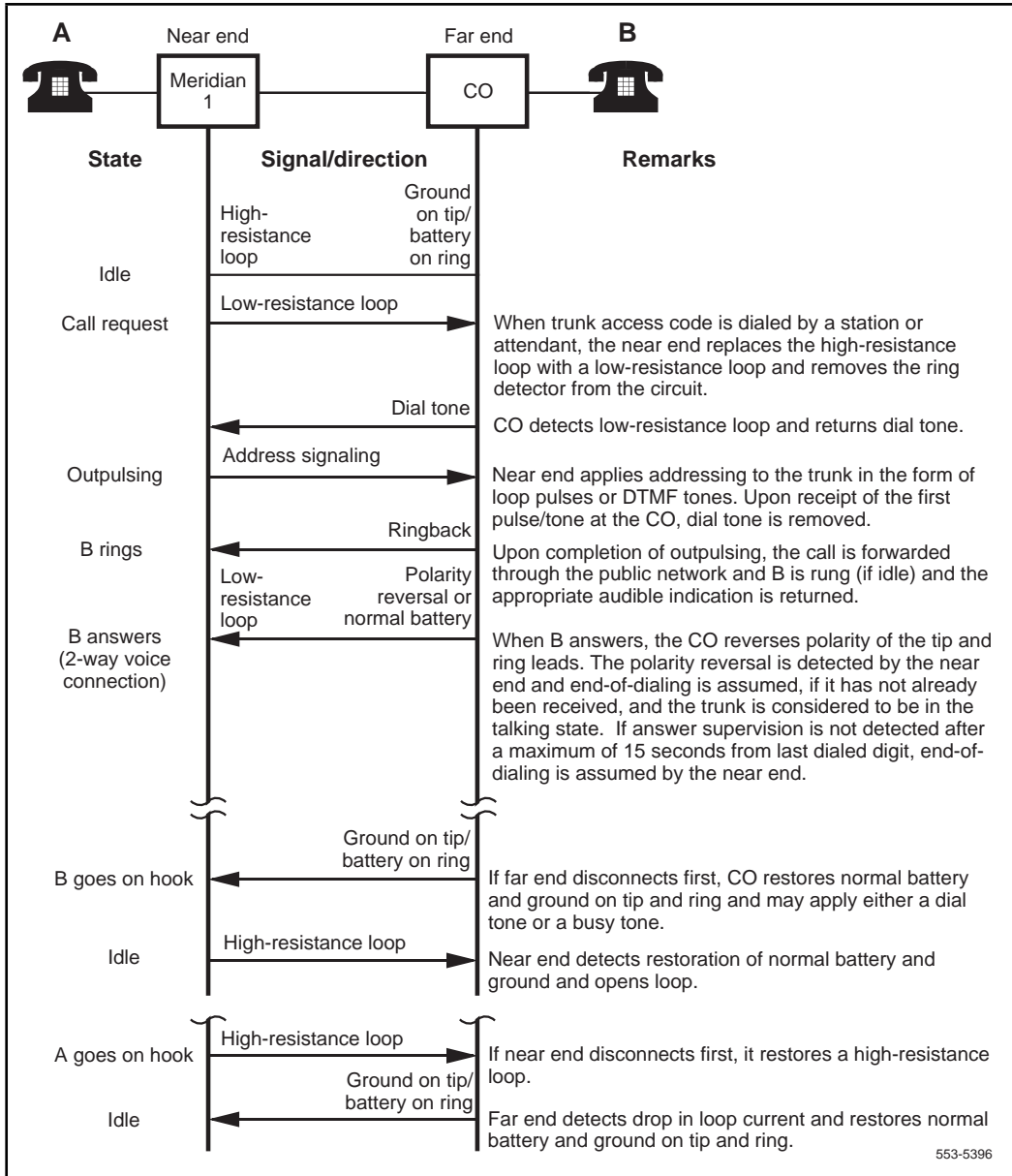


553 7724

**Figure 7**  
**Loop start call states—outgoing call to CO/FX/WATS**



**Figure 8**  
**Loop start call connection sequence—outgoing call to CO/FX/WATS**



553-5396

## Busy Tone Disconnect Supervision

The Busy Tone Disconnect Supervision feature is provided by the NT5D26AA EXUTAP-1 for use in Thailand and by the NT5D26BA EXUTAP-2 for use in Indonesia, Malaysia, and Singapore. This feature requires the Busy Tone Detection (BTD) software package 294.

The NT5D26AA EXUTAP-1 and the NT5D26BA EXUTAP-2 cards can be configured to support

- Busy Tone Disconnect Supervision for incoming calls only
- Busy Tone Disconnect Supervision for both incoming/outgoing calls

Busy Tone Disconnect Supervision can be applied on a per channel basis. This feature uses a Phaselock loop tone detector which monitors the input of the codec. The NT5D26AA EXUTAP-1 pack is designed to detect Busy Tone within a frequency of  $400\pm 25$  Hz, while the NT5D26BA EXUTAP-2 pack detects Busy Tone within a frequency of  $425\pm 25$  Hz. Both cards can detect a minimum Busy Tone level of -25 dBm. The ON/OFF cadence timing is software programmable with a tolerance of  $\pm 100$ ms. The selected ON/OFF cadence values can be increased in 25ms increments. When Busy Tone is detected by the tone detector, the tone burst cadences are presented to the Intel 83C51FA microcontroller in TTL logic level. The microcontroller checks the validity of the cadence before reporting to the Meridian 1 system CPU.

Busy Tone Disconnect Supervision resolves the supervision problem that occurs when the Meridian 1 system receives calls from an unsupervised Loop Start trunk. When these incoming calls are connected to a device such as Meridian Mail, and are subsequently disconnected, the Meridian 1 system is not informed and the trunk is held up unnecessarily. Busy Tone Disconnect Supervision provides Busy Tone detection which notifies the Meridian 1 system that the CO end has disconnected. The Meridian 1 trunk is subsequently restored to an idle state.



## Trunk configuration for Loop start operation

Busy Tone Disconnect Supervision for Loop Start signaling is configured in software through LD 97, LD 16, and LD 14.

### Busy Tone Detection (BTD) Data Block

Busy Tone Detection is configured in overlay 97, as described in Table 9.

**Table 9**  
**LD 97 Busy Tone Detection Data Block**

Prompt	Response	Comments
REQ	CHG	Modify existing data
TYPE	BTD	Busy Tone Detection
BTDT	(0)-7	Busy Tone Detection Table
BCAD	(350) (350)	Busy Tone Cadence (in milliseconds) (ON cycle) (OFF cycle)
	500 500	For Indonesia, Malaysia, and Thailand
	750 750	For Singapore
BTDD	(BOTH)	Busy Tone Detection on both incoming and outgoing calls
	INC	Busy Tone Detection on incoming calls only

### Route Data Block

Each trunk unit on the NT5D26AA EXUTAP-1, NT5D26AA EXUTAP-2 card is attached to a route with an associated route data block. Trunk timers are configured on a route basis. The route data block is programmed in overlay 16, as described in Table 10.

**Table 10**  
**LD 16 Route Data Block**

Prompt	Response	Comments
REQ	NEW	Add a new data block to the system
TYPE	RDB	Define a new Route Data Block
CUST	xx	Enter customer number
ROUT	0-511	Enter route number
	0-127	For Option 11

TKTP	COT	Define trunk type as Central Office
ICOG	IAO	Incoming and Outgoing trunk
CNTL	YES	Changes to controls or timers
NEDC	ETH	Either end control
FEDC	ETH	Either end control

### Trunk Data Block

Use overlay 14 to configure each of the trunk units on the NT5D26AA or NT5D26BA EXUTAP cards, as described in Table 11.

**Table 11**  
**LD 14 Trunk Data Block**

Prompt	Response	Comments
REQ	NEW	Define a new trunk unit
TYPE	COT	Central Office Trunk data block
TN	I s c u c u	Terminal number of the unit For Option 11
XTRK	EXUT	Type is IPE EXUT (This prompt is required only for the first unit defined on each card.)
SIGL	LOP	Loop Start signaling
TIMP	600	Termination impedance
BIMP	600 (3COM)	Balance impedance
SUPN	YES	Answer and disconnect supervision required
-STYP	PIP BTS PIP BTS	Supervision Type Polarity Insensitive Pack Busy Tone Supervision Both options
BTDT	(0)-7	Busy Tone Detection Table (This prompt is required only for the first unit defined on each card.)
CLS	(DIP) DTN	Dial Pulse Digitone

## Ground start operation

Ground start operation is configured in software and implemented through software download messages. In the idle state, the tip conductor from the CO is open and a high-resistance negative battery is present on the ring lead.

For configuration requirements, refer to the *Meridian 1 X11 input/output guide* and *Circuit Card Installation and Testing*.

## Incoming calls

In an incoming call, after ground is detected on the tip, the EXUTAP card scans for a ringing detection signal before presenting the call to an attendant and tripping the ringing. When the attendant answers, a low resistance is placed across the tip and ring conductors which trips CO ringing and establishes a speech path (see Figures 9 and 10).

### Reverse-wiring compensation

The Meridian 1 software includes a feature for detecting reverse wiring (connection of near-end tip and ring leads to far-end ring and tip leads, respectively) on ground start trunks with far-end answer supervision.

Ordinarily, an incoming call on a reverse-wired trunk without reverse-wiring compensation will present ringing on the tip lead rather than on the ring lead. Since software expects to see a ground on the tip lead, it will interpret the end of the first ringing signal as a switchhook flash. But since the interval between ringing signals exceeds the switchhook flash time of 512 milliseconds, software assumes far-end disconnect. This causes the call to be presented to a console loop key and then immediately removed.

The reverse-wiring compensation feature operates as follows. If an apparent disconnect takes place immediately after the first ringing signal, the software will time stamp the event and temporarily remove the call from the console loop key. If another such ringing/disconnect event occurs during the no ringing detector (NRD) time, the trunk will be considered “possibly reverse wired” and a threshold counter will be incremented. Calls on trunks identified as possibly reverse wired will be presented to the attendant during the initial ring, removed and then continuously presented after the second ring. If a call on a possibly reversed wired trunk is abandoned before the attendant answers, it will be disconnected after the NRD timer expires.

Trunks identified as possibly reverse wired will be switched by software to loop start processing after the second ring. This switching takes place on a call-by-call basis. Thus, if a previously correctly wired trunk becomes reverse wired, the next incoming call will be marked as possibly reverse wired and the threshold count will begin.

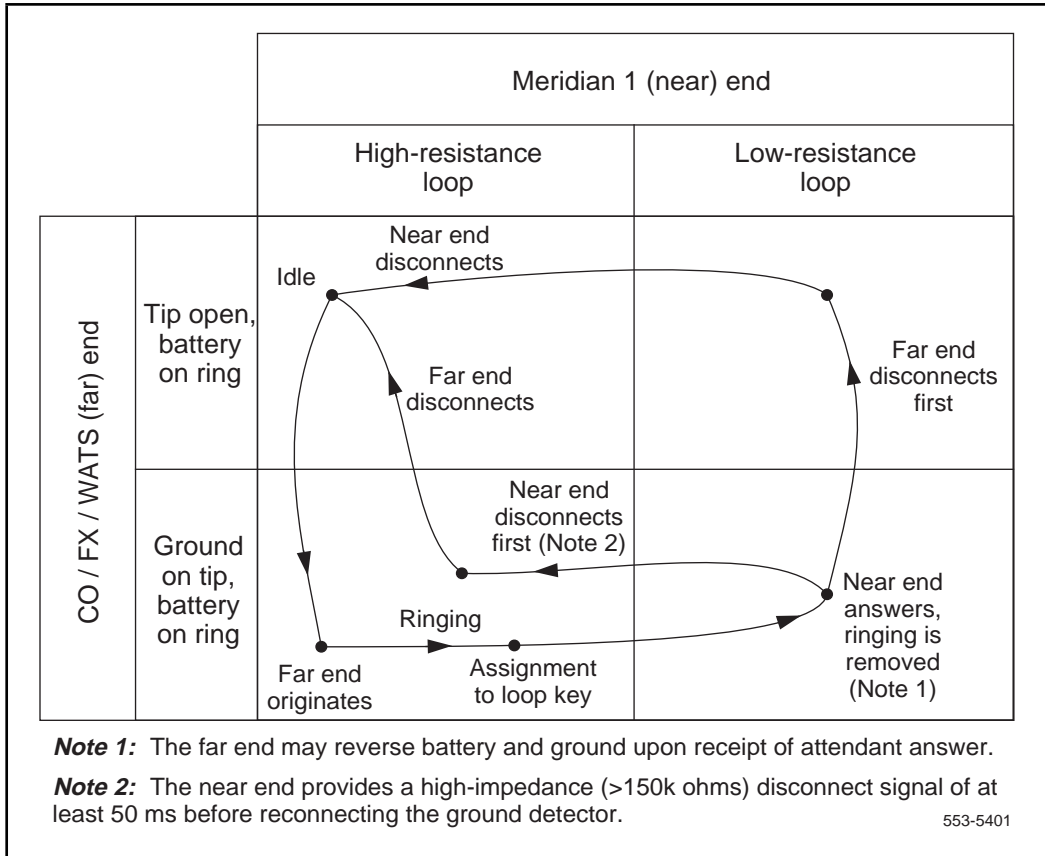
If the threshold count exceeds its limit, an error message is printed and the trunk is registered as “*positively* reversed wired.” Once identified as positively reversed wired, the call will be presented continuously from the first ring. When a reverse-wired trunk becomes correctly wired, the first subsequent call will clear the threshold counter and normal ground start processing will be implemented.

## Outgoing calls

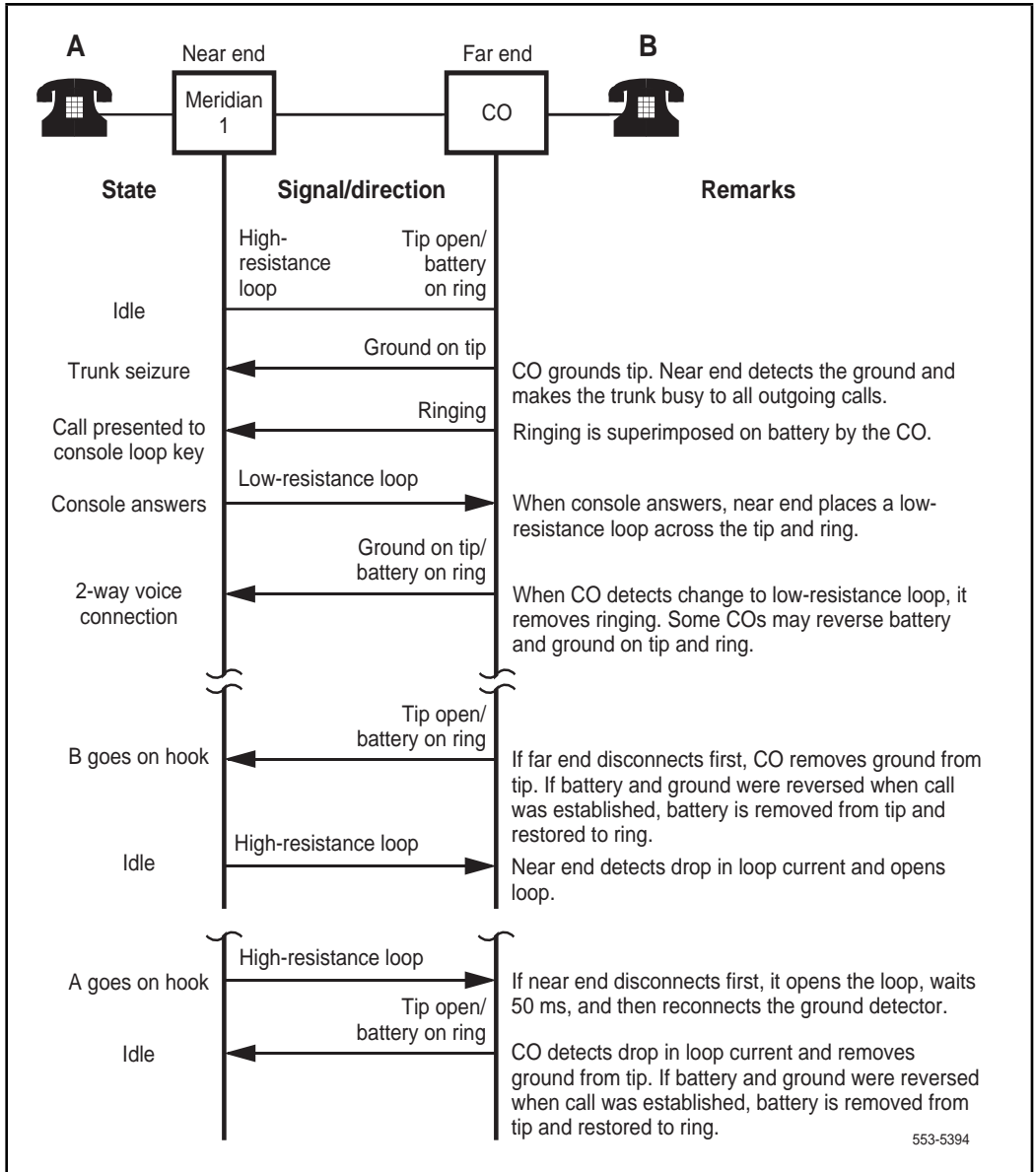
For outgoing calls, the trunk provides ground to the ring lead. The CO responds by grounding the tip and returning dial tone. After the tip ground is detected by the card, a low-resistance path is placed between the tip and ring leads and the ground is removed from the ring. Addressing is then applied from the Meridian 1 in the form of loop (interrupting) dial pulses or DTMF tones (see Figures 11 and 12).

The polarity-sensitive/-insensitive packs (PSP and PIP) feature must be set to provide for proper outgoing call-duration recording with ground start operation. Refer to the description of loop start operation in this section for a more complete discussion of PSP and PIP.

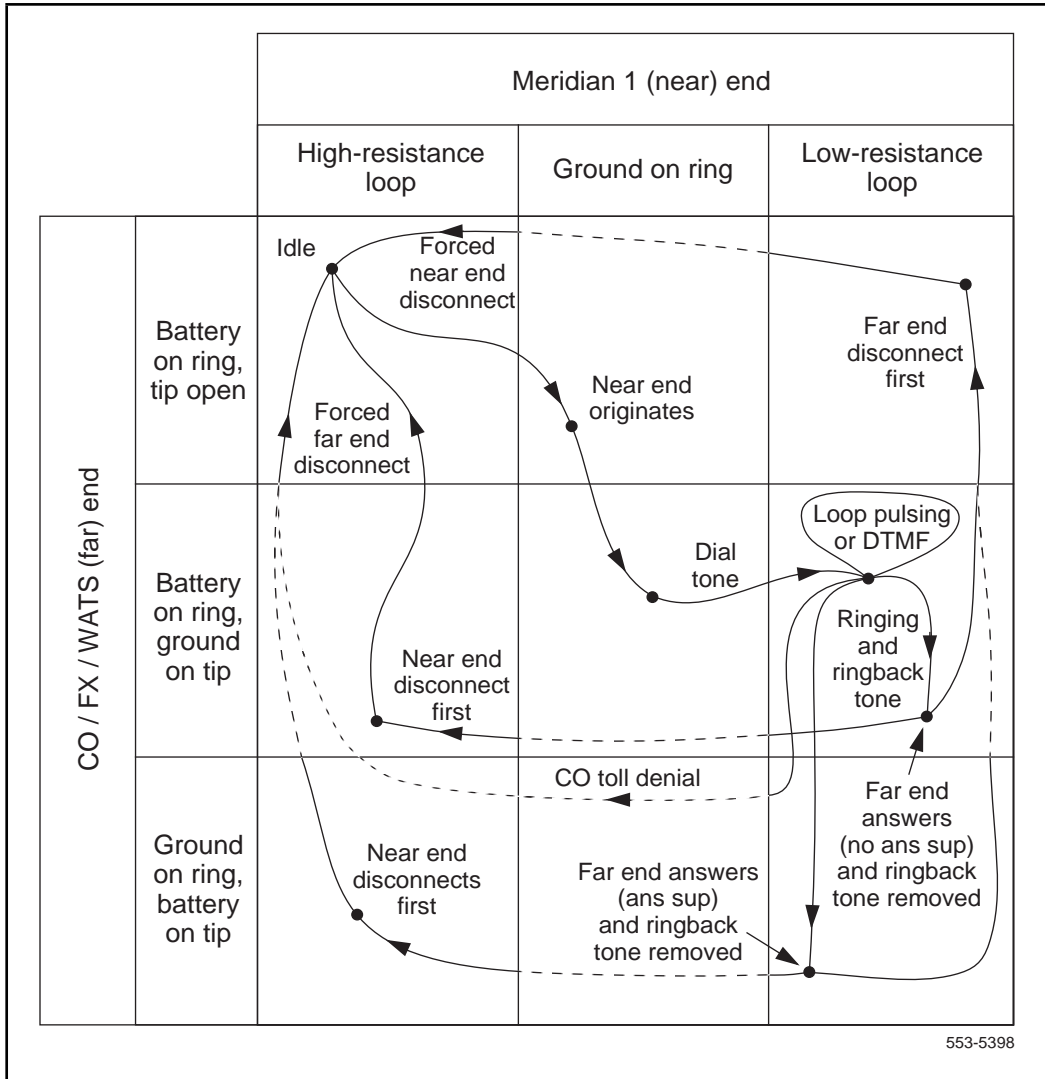
**Figure 9**  
**Ground start call states—incoming call from CO/FX/WATS**



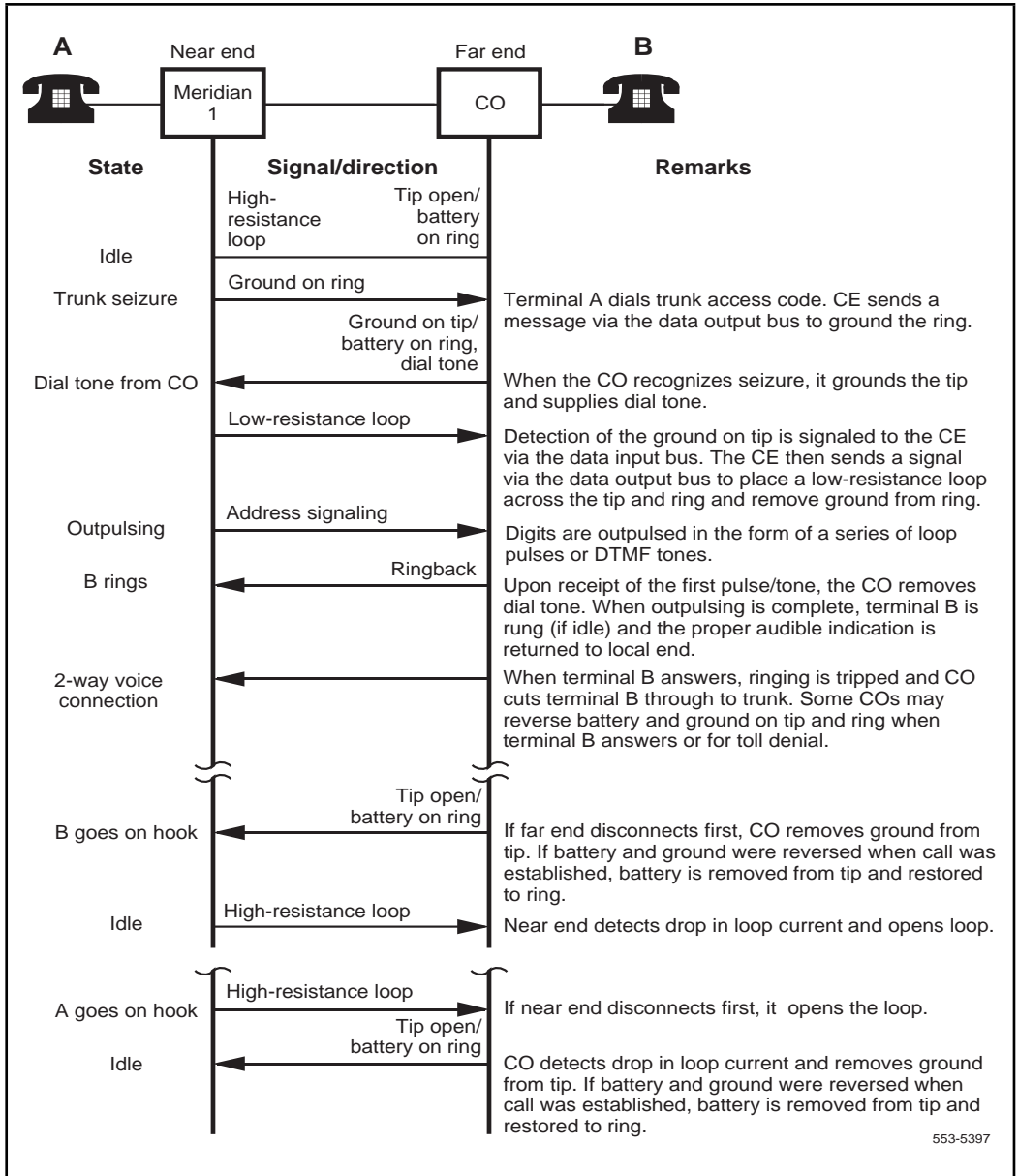
**Figure 10**  
**Ground start call connection sequence—incoming call from CO/FX/WATS**



**Figure 11**  
**Ground start call states—outgoing call to CO/FX/WATS**



**Figure 12**  
**Ground start call connection sequence—outgoing call to CO/FX/WATS**



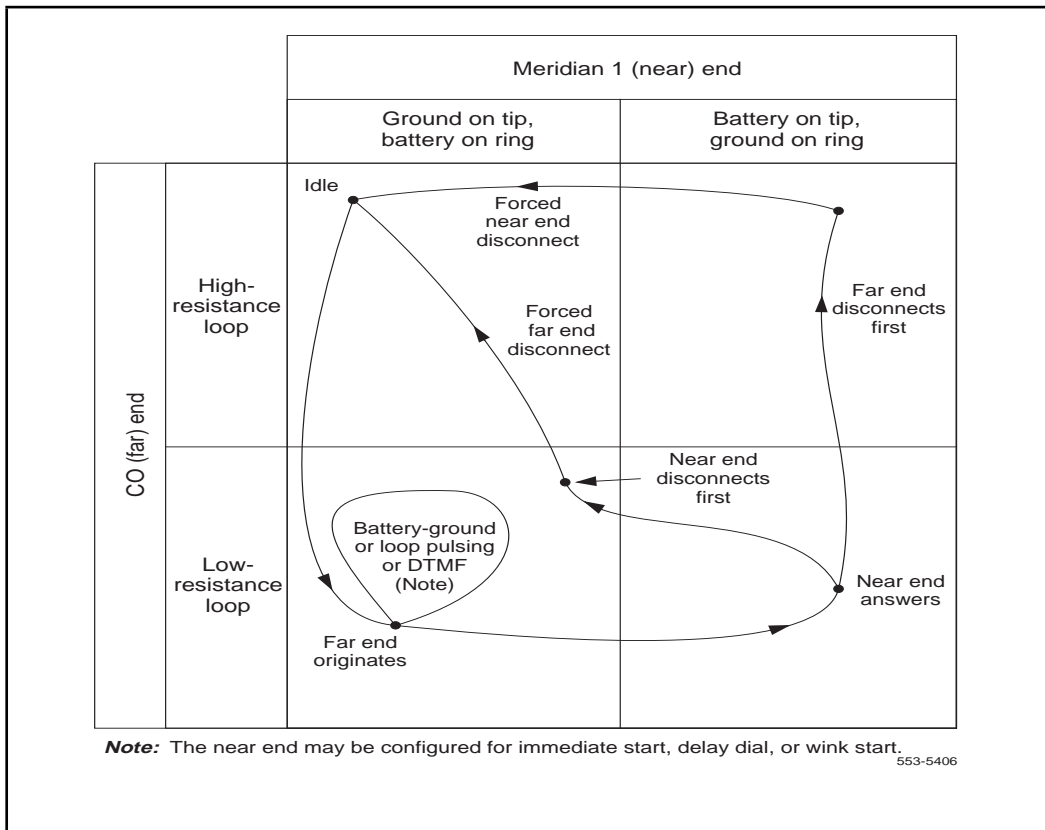


## Direct inward dial operation

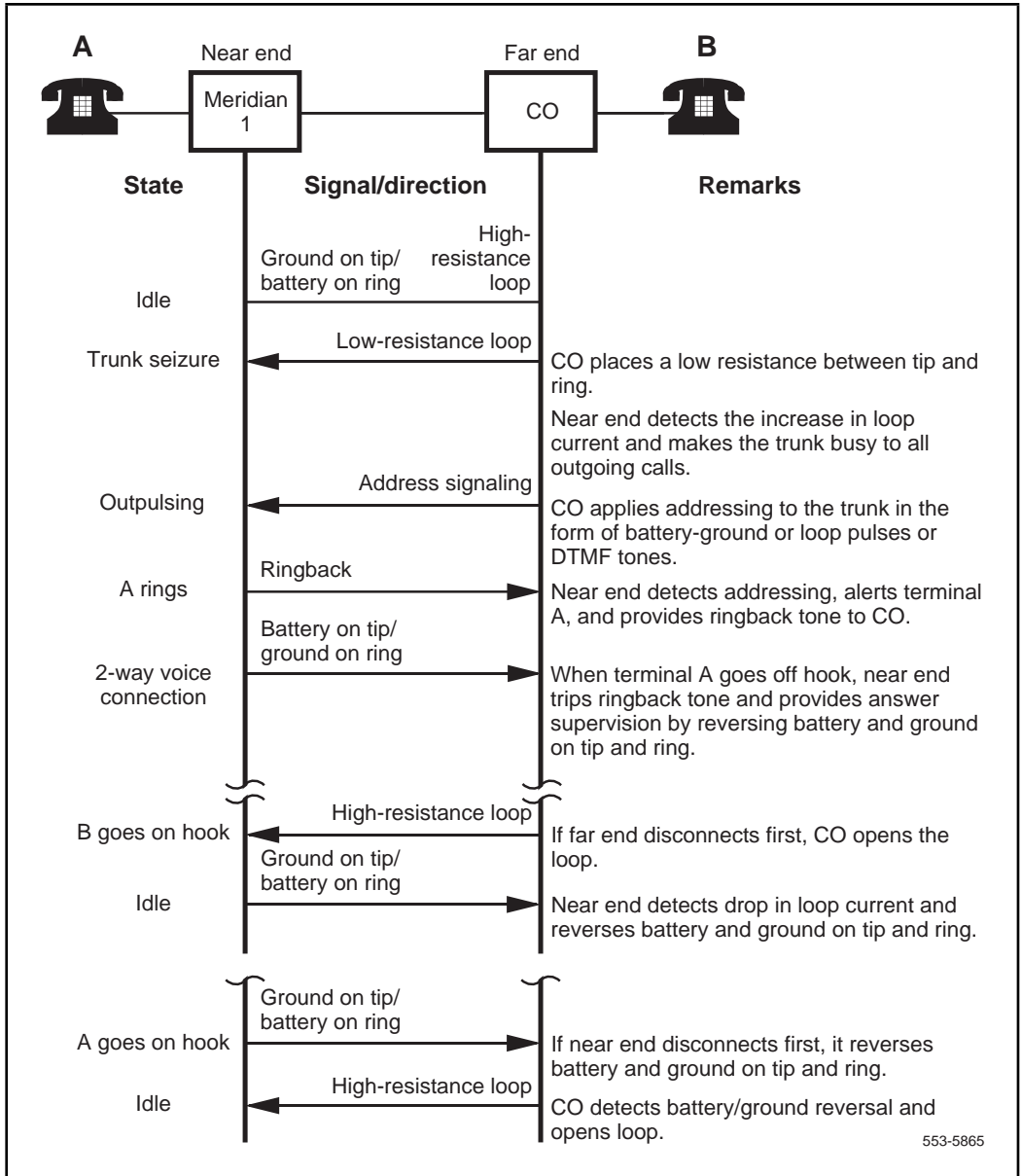
### Incoming calls

An incoming call from the CO places a low-resistance loop across the tip and ring leads (see Figures 13 and 14). Dial pulses or DTMF tones are then presented from the CO. When the called party answers, the EXUTAP card reverses battery and ground on the tip and ring leads to the CO. The trunk is arranged for first party release. The CO releases the trunk by removing the low-resistance loop, at which time normal battery and ground are restored at the near end. The operation represented in Figures 13 and 14 also applies to incoming TIE trunk calls from a far-end PBX.

**Figure 13**  
**DID trunk, Loop DR call states—incoming call from CO**



**Figure 14**  
**DID trunk, Loop DR call connection sequence—incoming call from CO**



553-5865

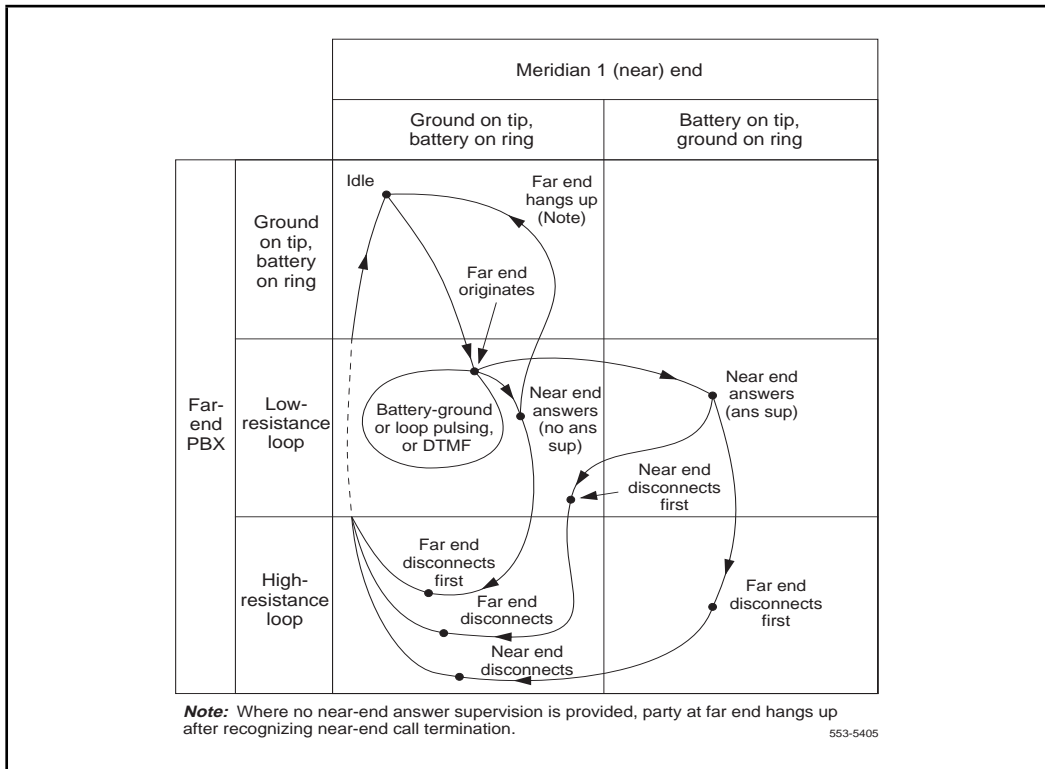
## Two-way, Loop Dial Repeating, TIE trunk operation

### Incoming calls

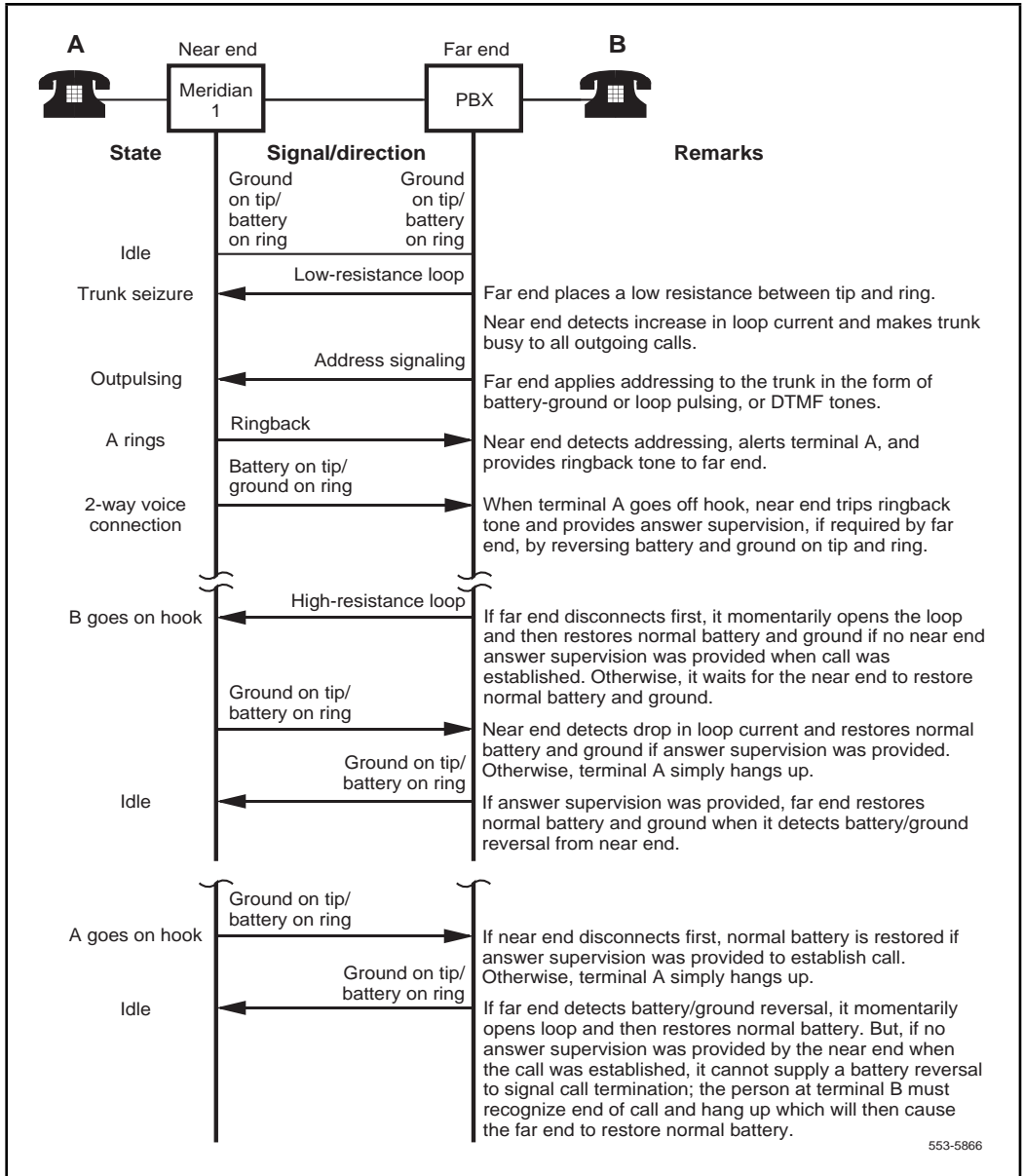
In an incoming call configuration, the far end initiates a call by placing a low-resistance loop across the tip and ring leads (see Figures 15 and 16). This causes a current to flow through the battery feed resistors in the trunk circuit. Address signaling is then applied by the far end in the form of DTMF tones or dial pulses. When the called party answers, an answer supervision signal is sent by software, causing the Meridian 1 to reverse battery and ground on tip and ring to the far end. Far-end disconnect is initiated by opening the loop while near-end disconnect is initiated by restoring normal battery and ground.

The operation represented in Figures 15 and 16 also applies to incoming DID trunk calls from a CO.

**Figure 15**  
Two-way, Loop DR, TIE trunk call states—incoming call from far-end PBX



**Figure 16**  
**Two-way, Loop DR, TIE trunk call connection sequence—incoming call from far-end PBX**

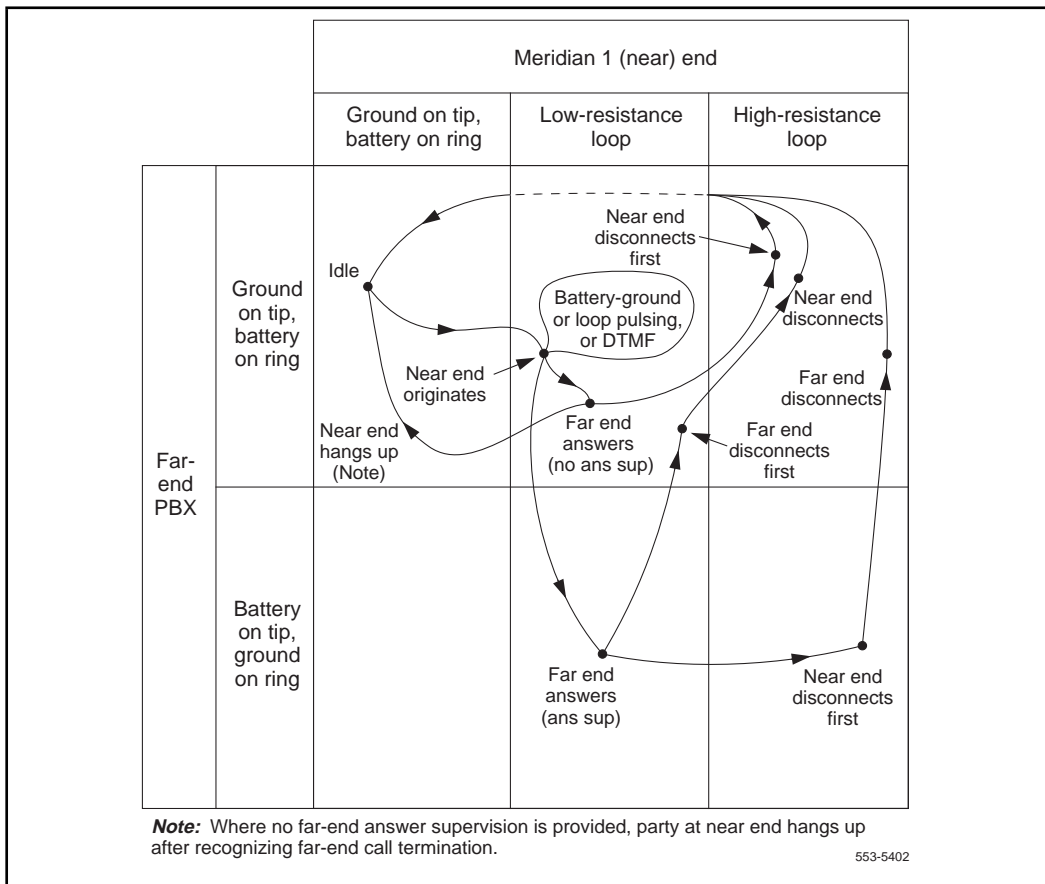


553-5866

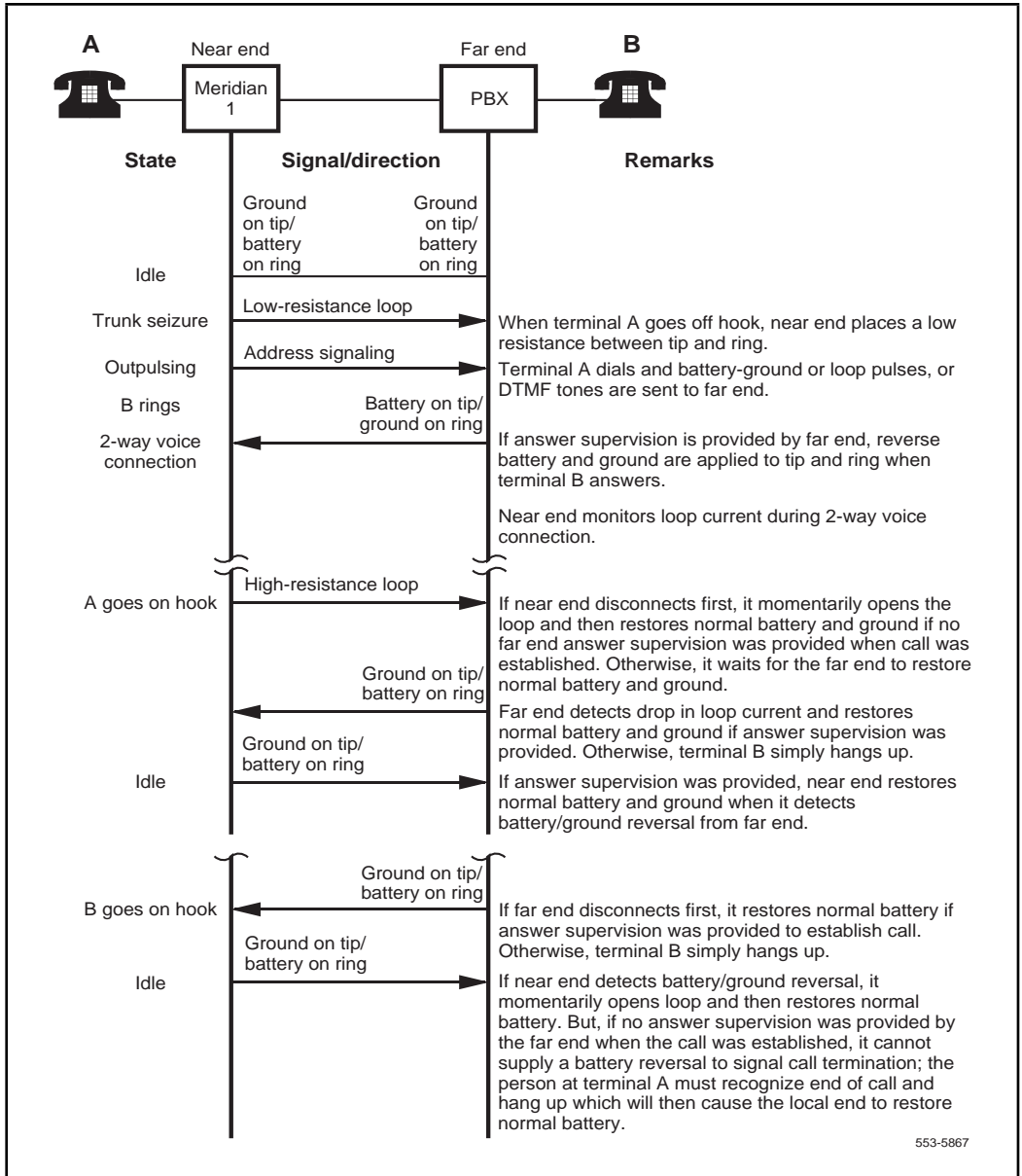
## Outgoing calls

In an outgoing call configuration, the EXUTAP card is connected to another PBX by a TIE trunk (see Figures 17 and 18). An outgoing call from the near end seizes the trunk facility by placing a low-resistance loop across the tip and ring leads. Outward addressing is then applied from the Meridian 1 in the form of DTMF tones or dial pulses. If answer supervision is provided by the far end, reverse battery and ground on tip and ring is returned. The operation represented in Figures 17 and 18 also applies to outgoing calls on a DID trunk.

**Figure 17**  
**Two-way, Loop DR, TIE trunk call states—outgoing call to far-end PBX**



**Figure 18**  
**Two-way, Loop DR, TIE trunk call connection sequence—outgoing call to far-end PBX**



## **Senderized operation for DID and two-way loop DR trunks**

### **Incoming calls**

If the far end is senderized, the near end may be operated in any mode: immediate start (IMM), delay dial (DDL) or wink (WNK) start, as assigned at the STRI prompt in the Trunk Administration program (LD 14) (see Figure 19).

For immediate start, following the seizure signal, the far end may start pulsing after the standard delay (normally 65 ms, minimum).

For delay dial or wink start modes, stop/go signaling, (off-hook/on-hook or battery/ground reversal) is returned by the Meridian 1 after receipt of the seizure signal. The delay dial (stop) signal begins immediately upon seizure and ends (go signal) 384 ms later. The wink start (stop) signal begins 384 ms after seizure and ends (go signal) 256 ms later. The far end detecting the go signal may start pulsing after the standard delay (normally 55 ms, minimum). Stop/go signaling, in addition to the signaling function, serves as an integrity check to help identify a malfunctioning trunk.

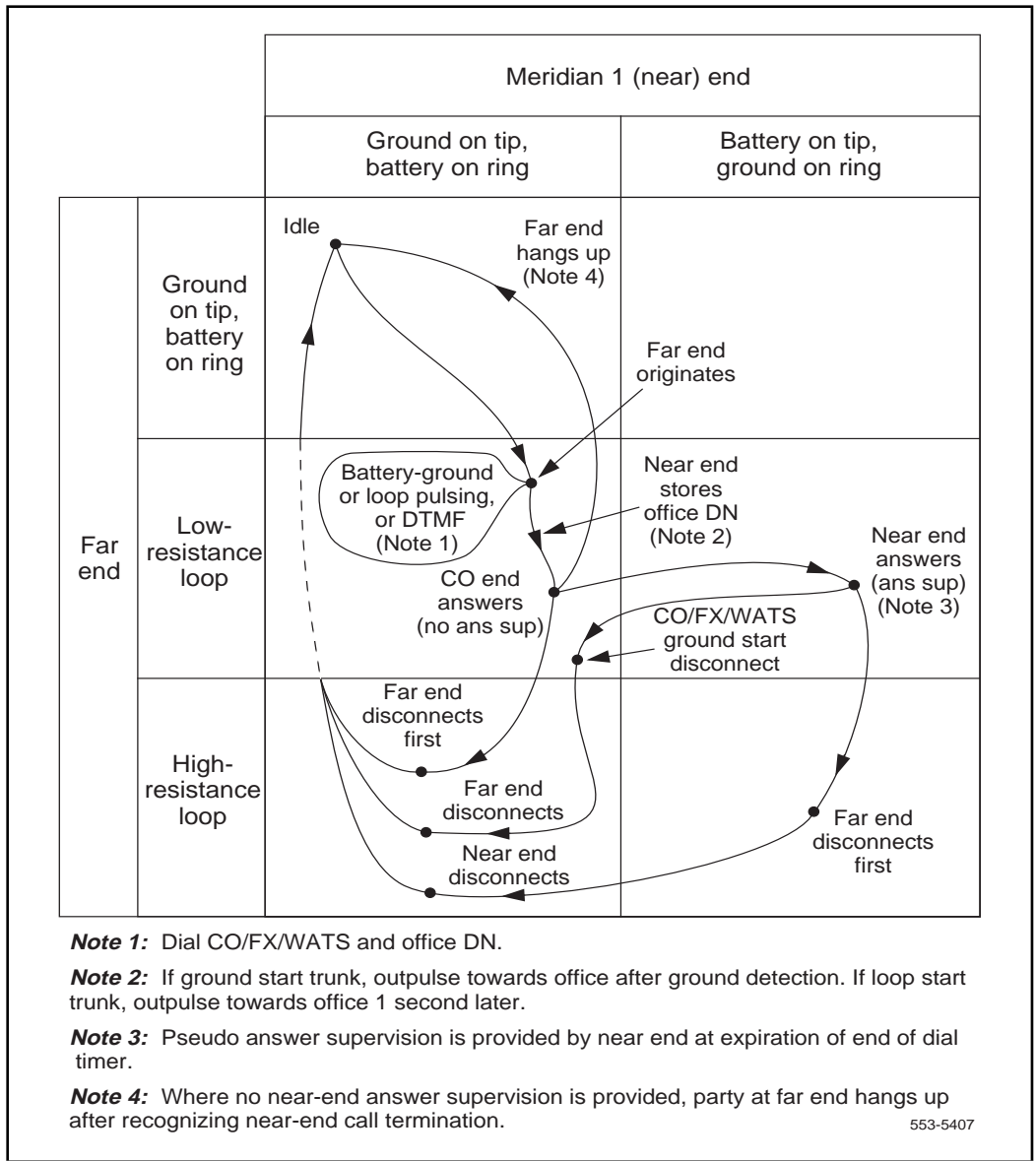
If required, the near end can be configured to provide pseudo answer supervision at expiration of the end of dial timer. End of dial timer settings are made at the EOD (non-DTMF) or ODT (DTMF) prompts in the Trunk Route Administration program (LD 16).

The operation represented in Figure 19 also applies to incoming calls on a DID trunk from a CO.

### **Outgoing calls**

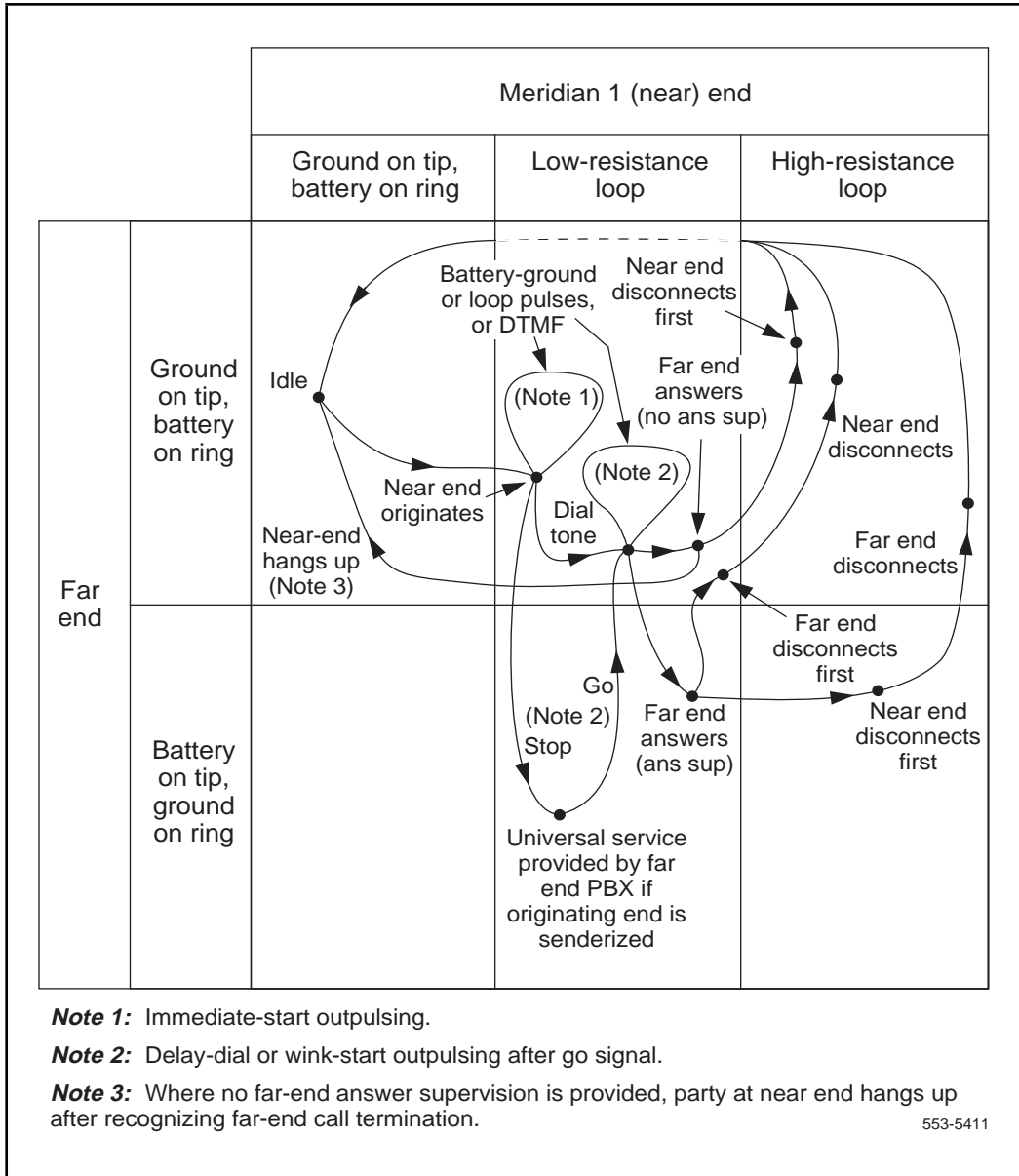
When DDL or WNK mode is used, outgoing calls require a stop/go signal from the far end so that the near end cannot outpulse until the far end is ready to receive digits (see Figure 20).

**Figure 19**  
**Two-way, Loop DR, TIE trunk call states—incoming call through senderized, tandem PBX from a CO/FX/WATS trunk**





**Figure 20**  
**Two-way, Loop DR, TIE trunk call states—outgoing call through far-end PBX to CO/FX/WATS**



## **Outgoing automatic, incoming dial operation**

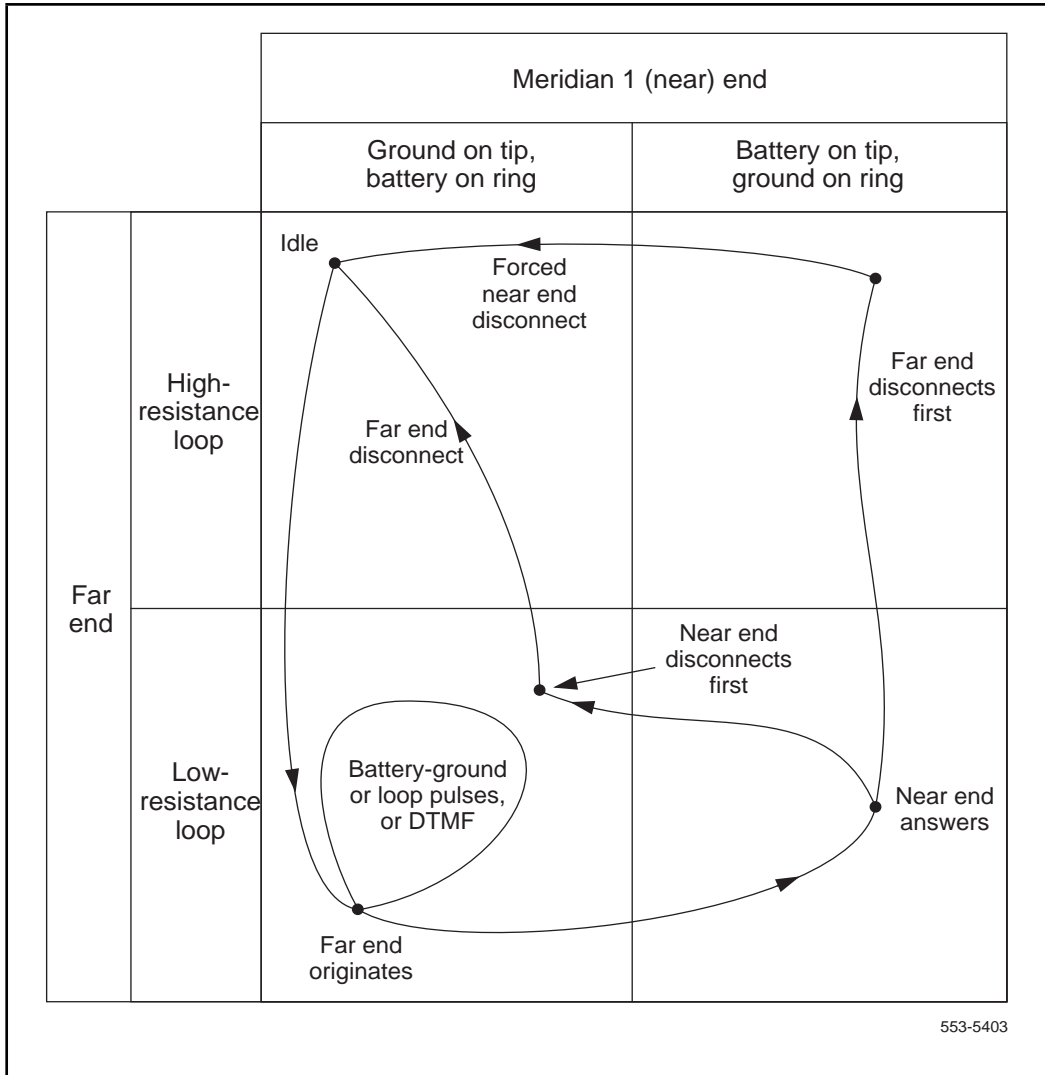
### **Incoming calls**

When the EXUTAP card is seized by the far end on an incoming call, a low-resistance loop is placed across the tip and ring leads. Addressing is then sent by the far end in the form of battery-ground or loop pulses, or DTMF tones. The trunk is released at the far end when the loop is opened. When the near end detects an open loop, it returns to a normal state. See Figures 21 and 22.

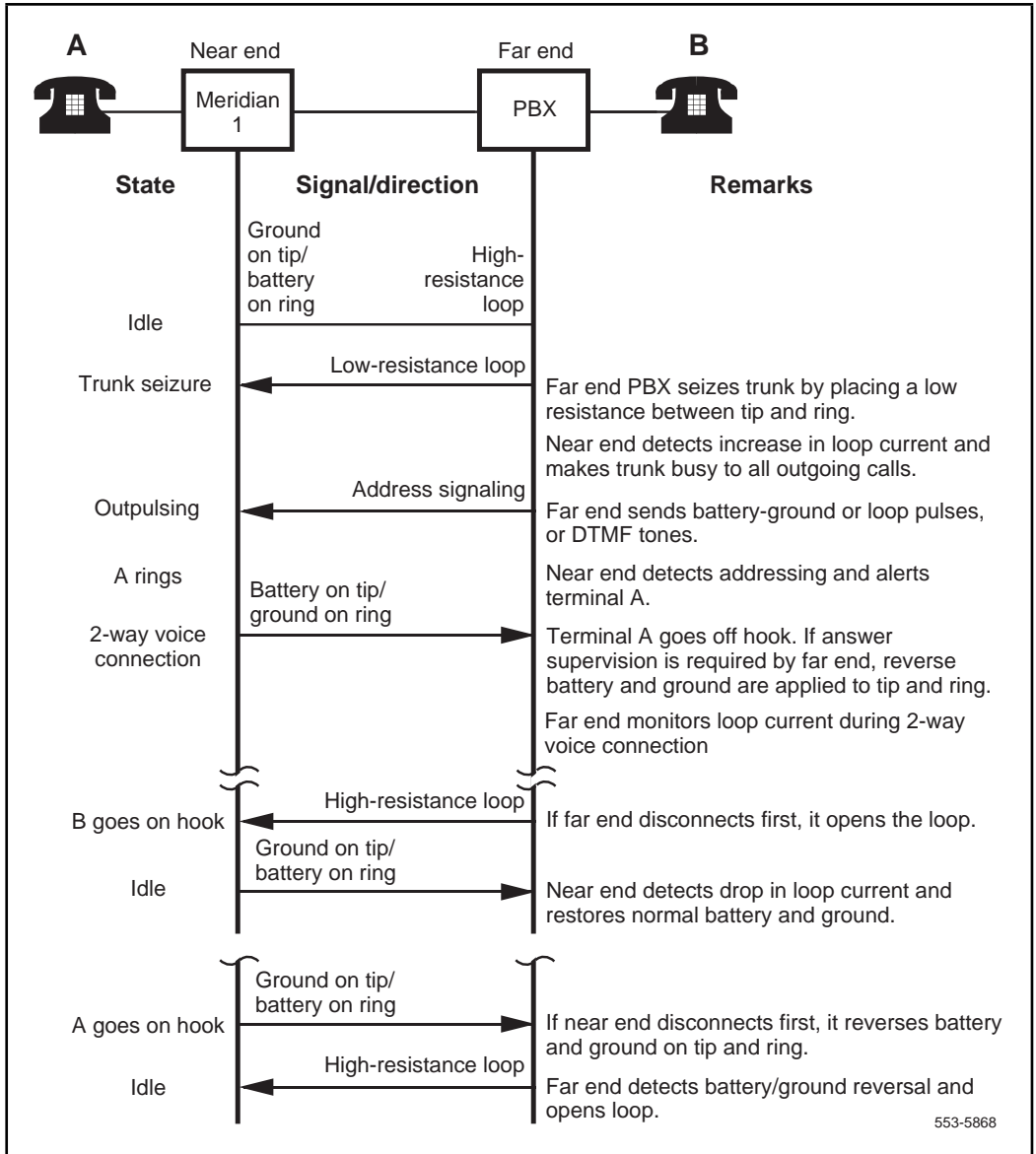
### **Outgoing calls**

When seized as a dial-selected outgoing trunk, the near end places battery on the tip and ground on the ring. This alerts the far end of the seizure. The far end responds with a low resistance across the tip and ring leads. See Figures 23 and 24.

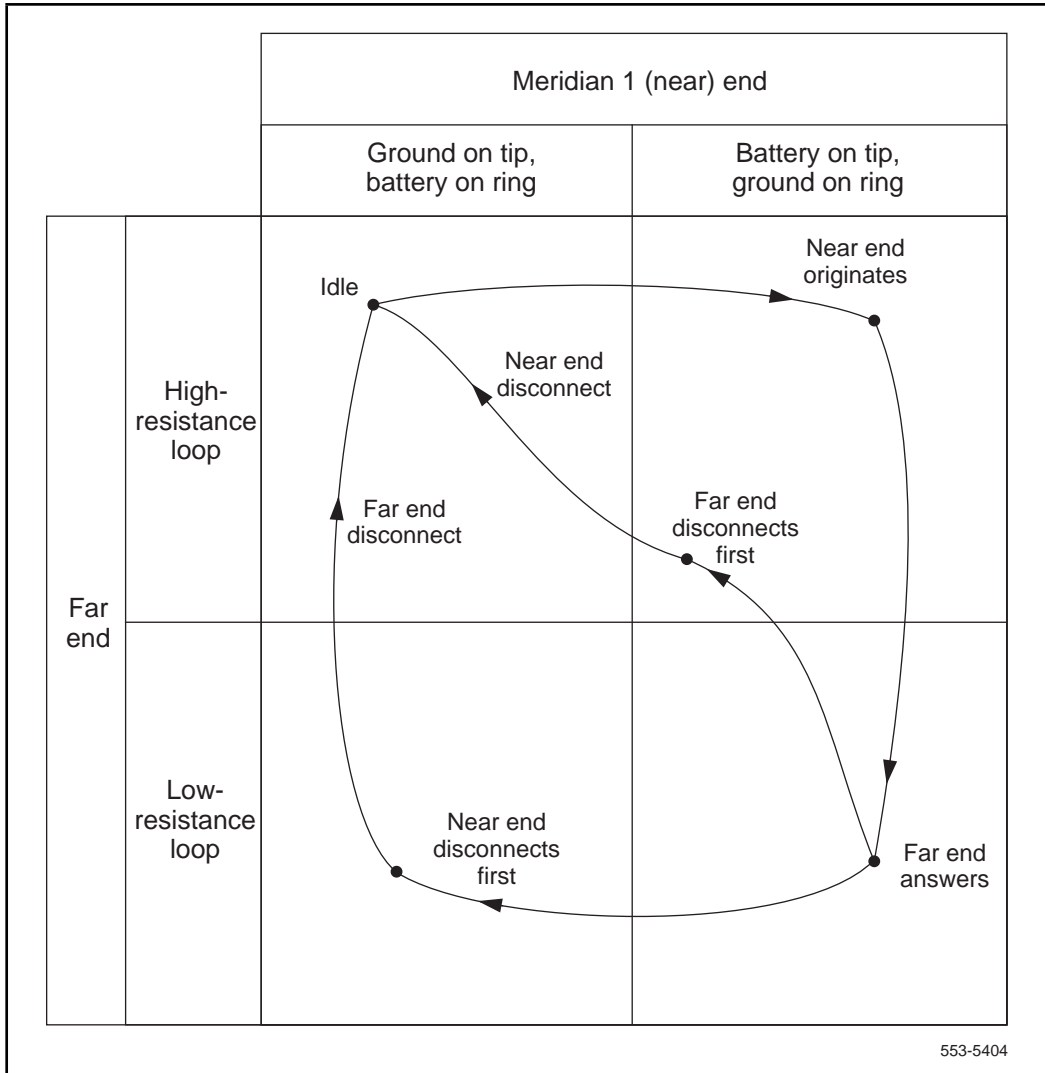
**Figure 21**  
**Two-way, loop OAID, TIE trunk call states—incoming call from far-end PBX**



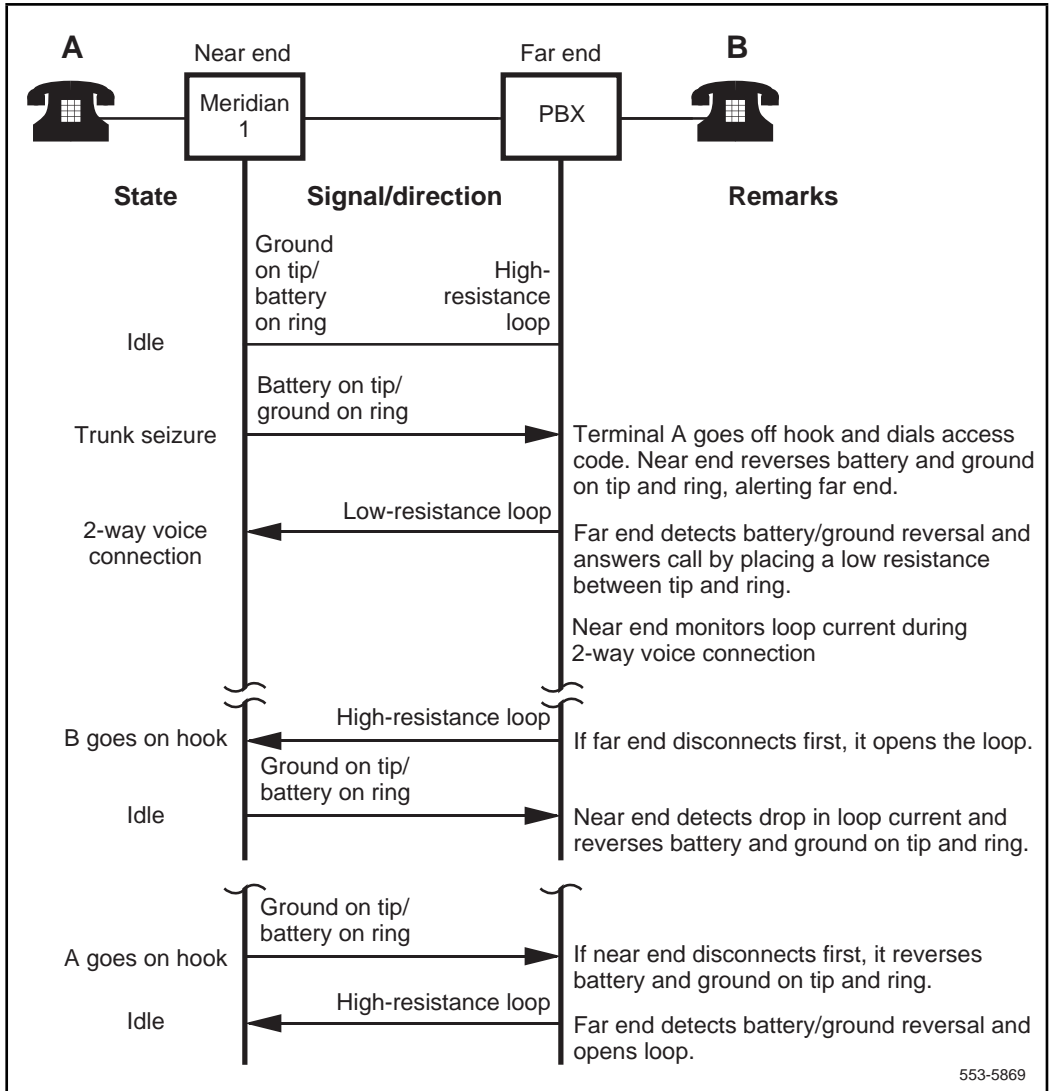
**Figure 22**  
**Two-way, loop OAID, TIE trunk call connection sequence—incoming call from far-end PBX**



**Figure 23**  
**Two-way, loop OAID, TIE trunk call states—outgoing call to far-end PBX**



**Figure 24**  
**Two-way, loop OAID, TIE trunk call connection sequence—outgoing call to far-end PBX**



## Recorded announcement trunk operation

When configured for Recorded Announcement (RAN) operation, a trunk unit is connected to a customer provided recorded announcement machine.

Announcement machines must be compatible with Meridian 1 RAN trunks and should be set up according to the manufacturer's instructions. Table 12 lists announcement machines that are available from Northern Telecom.

**Table 12**  
**Northern Telecom Digital Announcers**

NT model no.	No. of chan	Voice sampling rate	Trunk connections	Available options		
				Remote record	Message times	Firmware
NT7M00	1	32 kHz or 22 kHz (switch selectable)	Hard-wired	Yes, with beep prompts	32 sec (std), 1, 1-1/2, 2, 3, 4, 5, 6, 7, 8 min	Basic single channel
NT5M02	2	32 kbps or 64 kbps (switch selectable)	RJ-21 connect- orized	Yes, with voice prompts	1 (std), 2, 3, 4, 5, 6, 7, 8 min	Basic multi-channel
NT5M04	4					Multi-chan/multi-user
NT5M06	6					Multi-chan demand phased
NT5M08	8					Multi-chan fixed length Split mem—demand phased
<p><b>Note:</b> The 2, 4, and 6 channel models of the NT5M can be upgraded to 8 channels in a single chassis.</p> <p>Both the NT7M and the NT5M are programmable for the continuous operation, pulse start, and level start modes of operation.</p> <p>Adapters are available for hardwired (wire-wrap), RJ-11 modular, or RJ-21 jack interfaces.</p> <p>The audio output of both the NT7M and the NT5M are 4 ohms, nominal.</p>						

Each trunk unit provides the following for operation with RAN equipment:

- pulse start, level start, or continuous operation modes
- selectable termination of tip and ring leads into 600 or 900 ohms for interface with a low-impedance (2- or 4-ohm) source
- connection of up to 24 trunk units to a single announcement machine channel

## **Recorded announcement machines**

Recorded announcement machines store prerecorded voice messages which are played back to the trunk units to which they are connected. Most commercially available announcement machines store recordings digitally, although some drum and tape units are still in service.

An announcement machine may provide one or more channels and each channel may be prerecorded with a different message. Some announcement machines also provide a special information tone (SIT) capability. These tones are inserted at the beginning of intercept messages (such as “Your call cannot be completed as dialed. Please check the number and try again.”)

Figure 25 shows a typical connection from a single announcement machine channel to unit 0 on a Universal Trunk card installed in slot 0 in an NT8D37 IPE Module. See *Meridian 1 system installation procedures* for complete trunk wiring information.

## **RAN modes of operation**

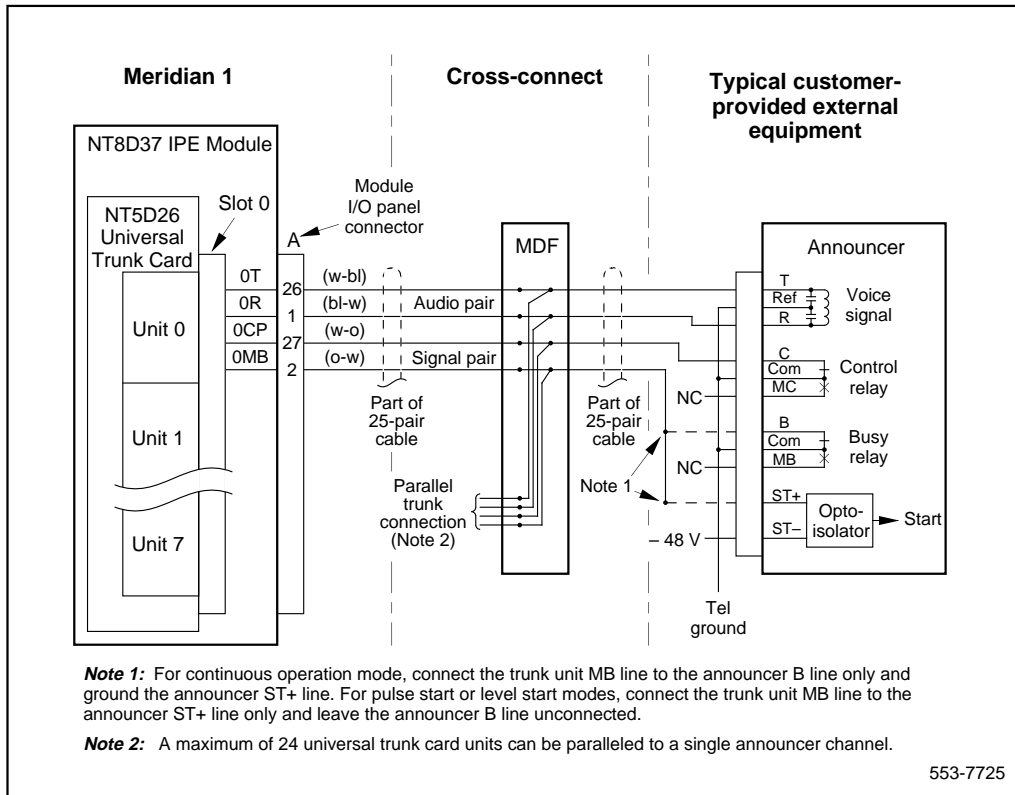
Figure 26 shows the relationship of control signals to message playback for the operating modes available in announcement machines. The signal names shown in the figure are typical of Northern Telecom digital announcement machines and are used here for comparison to other manufacturer’s equipment that might be used.

### **Continuous operation mode**

In the continuous operation mode (sometimes called the *audichron* mode), a message is constantly played, over and over again. Callers “barge in” on a playing message or are provided with a ringback tone until the message begins its next playing. The start line (ST+) is hardwired to always be active. See Figure 26. At the end of each message, a pulse is issued on the “C” line that is used by the trunk unit to cut through to the waiting call.

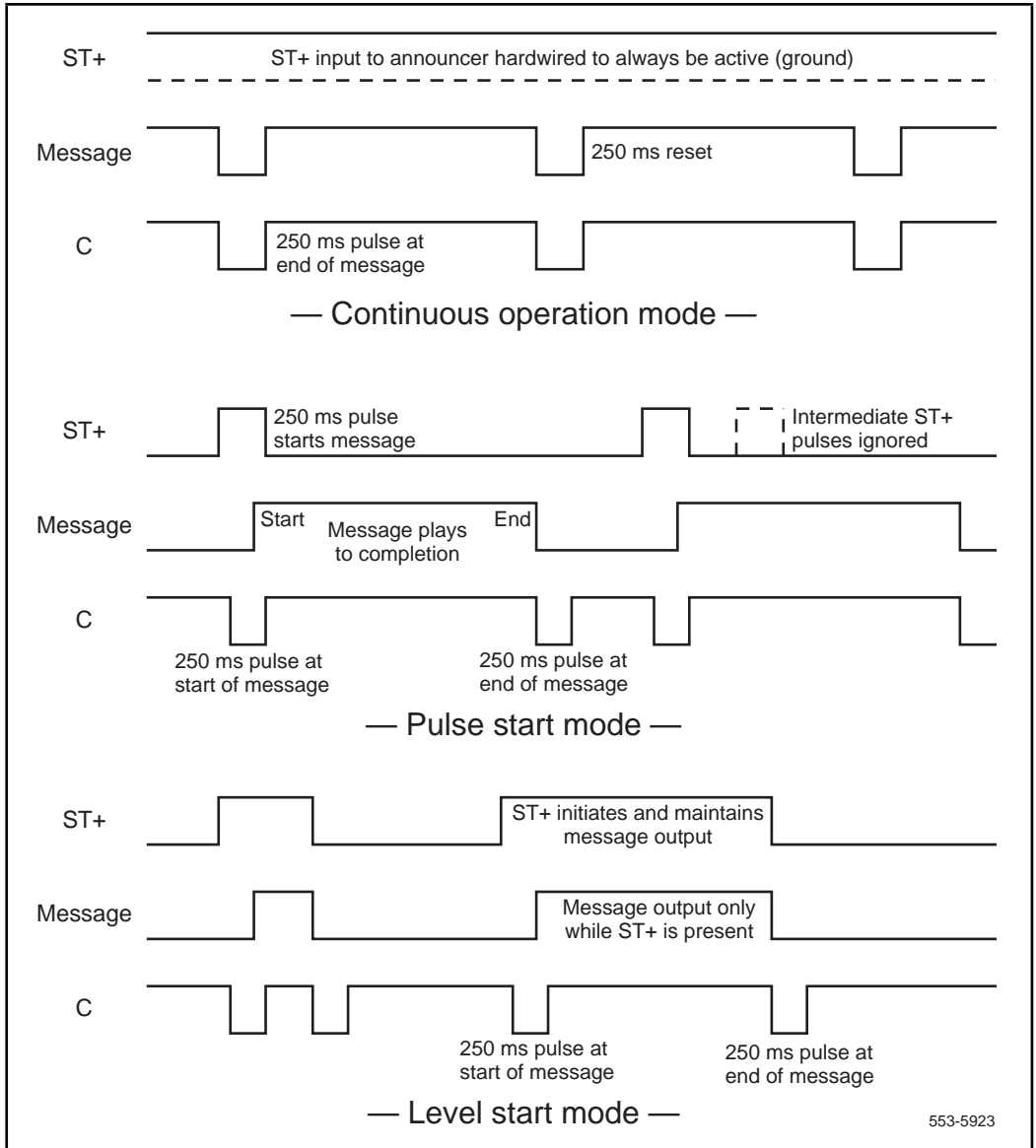


**Figure 25**  
**Connecting RAN equipment to the NT5D26AA and NT5D26BA**  
**Universal Trunk card (typical)**



**Note:** The “B” (busy) signal line shown in Figure 25 (not represented in Figure 26) is used to indicate availability of an announcement machine message to the trunk unit when configured for the continuous operation mode. This signal is made active (ground) by the announcement machine if the channel contains a recorded message and is in an on-line condition. The “B” line is not connected to a trunk unit when configured for start mode operation.

**Figure 26**  
**RAN control signals**



### **Start modes (minimum vintage BA)**

In a start mode (sometimes called the *code-a-phone* or *start-stop* mode), playback of a message does not begin until a start pulse is received by the announcement machine. Two sub-categories of the start mode exist, pulse start and level start.

In the pulse start mode, a start pulse activates playback of a message that continues until completion. See Figure 26. The announcement machine ignores all other start pulses which might occur until the message is complete.

In the level start mode, the start signal is a “level” rather than a pulse. The leading edge of the start signal initiates message playback that continues until either the trailing edge of the start signal occurs or the end of the message is reached. A message that is terminated by the trailing edge of a level start signal is immediately reset and again made available for playback.

## **Call routing to RAN trunks**

Software programs in the Meridian 1 control Recorded Announcement machines. These programs detect the calls to be intercepted, determine the type of intercept treatment required (overflow, attendant, announcement, etc.), queue the intercept, and provide ringback tone to the calling party. At the proper time, an intercepted call is connected to the appropriate RAN trunk.

## **Programming RAN trunks**

The type of intercept and the RAN trunk parameters are defined in the Trunk Administration (LD 14), Customer Data Block (LD 15), and Trunk Route Administration (LD 16) programs.

The Trunk Administration and Route Administration programs specify the RAN trunk, the type of announcement machine, the number of repetitions of announcements before a forced disconnect (all calls) or an attendant intercept is initiated (CCSA/DID calls only), and the point at which the trunk may be connected to the announcement.

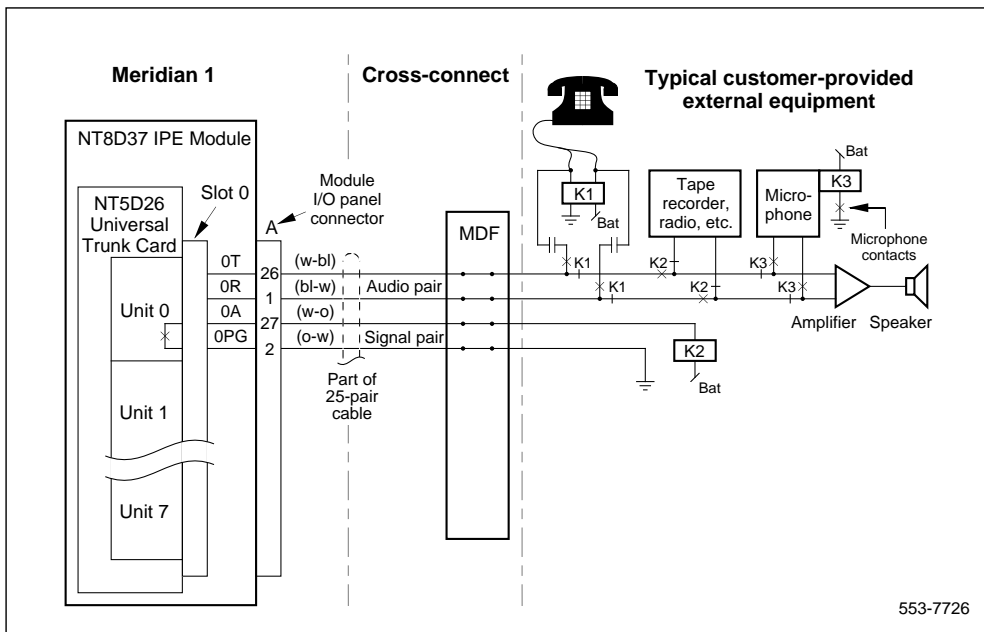
The Customer Data Block program defines the type of intercept and the trunk route to which the intercept is to be connected.

Refer to the *X11 input/output guide* for complete instructions on service change programs.

## Paging trunk operation

A Universal Trunk card unit can be configured as a paging trunk. Configure units as Paging trunks in the Trunk Administration program (LD 14) and assign routes in the Route Administration program (LD 16). Figure 27 shows a typical connection from customer provided equipment to unit 0 on a Universal Trunk card that is installed in slot 0 in an NT8D37 IPE Module. See *Meridian 1 system installation procedures* for complete trunk wiring information.

**Figure 27**  
**Connecting paging equipment to the NT5D26AA or NT5D26BA**  
**Universal Trunk card (typical)**



## Music operation

A trunk unit can be connected to a music source. The audio source should provide an adjustable power output at 600 ohms. Configure units for music at the MUS or AWR prompts in the Trunk Administration program (LD 14) and assign routes at the MRT prompt in the Trunk Route Administration program (LD 16).

Music operation is similar to that of RAN in the continuous operation mode. Connect the unit tip and ring leads to the audio source and ground the CP line at the MDF. See Figure 25. If the music source is equipped with contacts that close when music is on line, use these contacts to provide a ground to the MB line; otherwise, ground the MB line at the MDF.

---

# Digital Signal Processing Extended Universal Trunk Card

---

## Overview

The NT5D31AA Digital Signal Processing Extended Universal Trunk Card for Asia Pacific, and CALA (DXUT) is an Intelligent Peripheral Equipment (IPE) circuit card which may be installed in either the NT8D37 IPE Module or the NT8D11 CE/PE Module.

The DXUT card uses Digital Signal Processing (DSP) technology for tone detection intelligence that accurately differentiates between different disconnect tones sent by a Public Exchange/Central Office. Either single frequency or dual tone frequency busy tones can be detected by the DXUT. These tones are detected with greater precision as a result of software controllable *center frequencies, cadences, and levels of detection*. The Busy Tone Detection feature of the NT5D31AA DXUT card requires a minimum of X11 Release 23 software and the Busy Tone Detection (BTD) package 294.

The DXUT card provides the interface between eight trunks and the Meridian 1 system. Each trunk interface is independently configurable by software control in the Trunk Administration program (Overlay 14).

Flexible Busy Tone Detection is configurable on the DXUT card within the programmable center frequency ranges of 350 to 665 Hz at 5 Hz increments. The programmable cadences ON/OFF durations range from 0 to 1500 ms in 25 ms increments. The minimum level range of busy tone required for disconnect supervision is -20 to -35 dBm. The maximum level range of busy tone required for disconnect supervision is 0 to -15 dBm. The tone levels of detection are programmable in 5 dB intervals.

The tolerance is always  $\pm 25$  Hz of the center frequency programmed.

The NT5D31AA DXUT card supports the following trunk types:

- Central Office (CO) Ground Start, Foreign Exchange (FEX), and Wide Area Telephone Service (WATS) trunks
- Central Office Loop start signaling with Busy Tone Disconnect Supervision trunks
- Direct Inward Dial (DID) trunks
- TIE: two-way Loop Dial-Repeating (LDR) and two-way loop Outgoing Automatic Incoming Dial (OAID) trunks
- Recorded Announcement (RAN) trunks
- Paging (PAGT) trunks
- Outgoing Automatic Number Identification (OANI) trunks

The DXUT card also supports Music, Automatic Wake Up, and Direct Inward System Access (DISA) features.

Table 13 is a matrix of the signaling and trunk types supported by the NT5D31AA DXUT card.

**Table 13**  
**Trunk and signaling matrix**

Signaling type	Trunk types				
	CO/FEX/WATS	DID	TIE	RAN	Paging
Loop start	Yes	No (see note)	No	N/A	N/A
Ground start	Yes	No	No	N/A	N/A
Loop DR	No	Yes	Yes	N/A	N/A
Loop OAID	No	No	Yes	N/A	N/A
Continuous operation mode	No	No	No	Yes	N/A
Start modes (pulse and level)	No	No	No	Yes	N/A
<b>Note:</b> For incoming and outgoing service, DID trunks must be programmed as Loop Dial Repeating (LDR).					



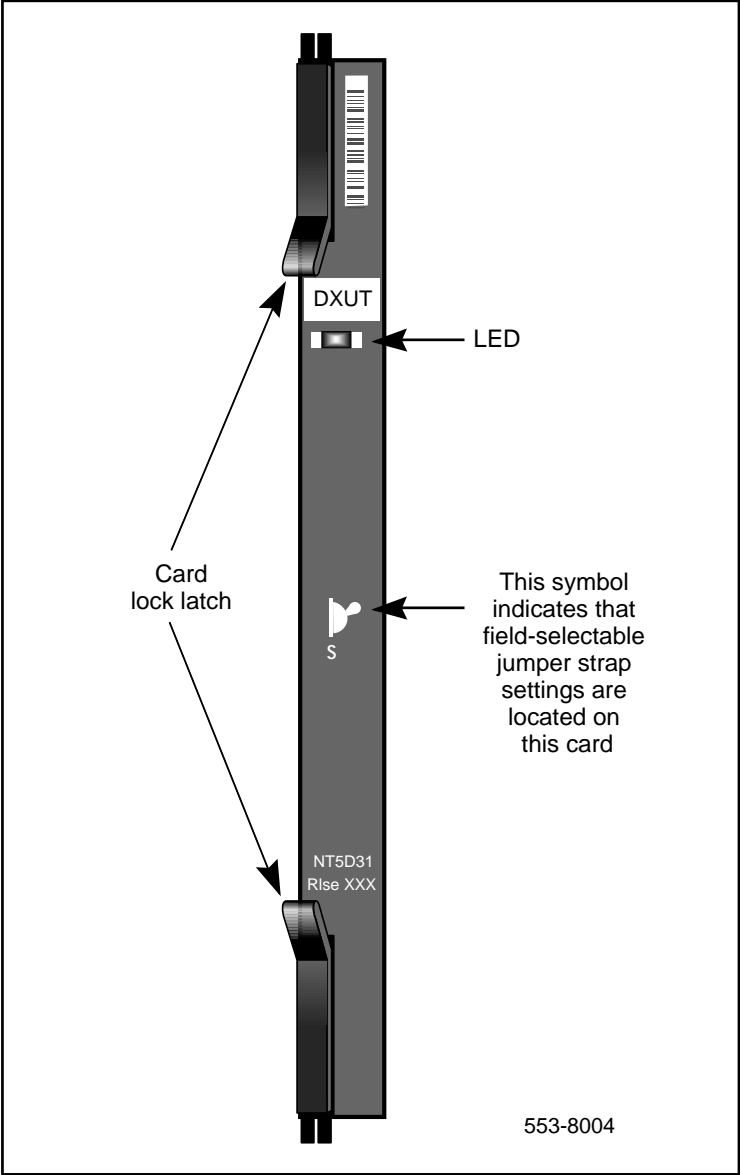
## Physical description

The NT5D31AA DXUT card mounts in any IPE slot. The trunk and common multiplexing circuitry is mounted on a 31.75 by 25.40 cm (12.5 by 10 in.) printed circuit board.

The NT5D31AA DXUT card connects to the backplane through a 160-pin connector shroud. The backplane is cabled to the input/output (I/O) panel, which is cabled to the Main Distribution Frame (MDF) by 25-pair cables. External equipment, such as Recorded Announcement machines, Paging equipment, and Central Office facilities, connect to the cards at the MDF. See *Meridian 1 system installation procedures* for termination and cross-connect information.

The faceplate of the card is equipped with a red, light-emitting diode (LED) (see Figure 28). When a DXUT card is installed, the LED remains lit for two to five seconds while the self-test runs. If the self-test completes successfully, the LED flashes three times and remains lit until the card is configured and enabled in software, then the LED goes out. If the LED does not follow this pattern or operates in any other manner, such as continually flashing or remaining weakly lit, the card should be replaced.

Figure 28  
NT5D31 DXUT card - faceplate



## Functional description

This functional description of the NT5D31AA DXUT card is divided into two parts. First, a description of the card's control, signaling, and power interfaces is given, followed by a description of how the card functions.

### Card interfaces

Figure 29 shows the position of the NT5D31AA DXUT card within the Meridian 1 system architecture.

#### Voice and signaling interfaces

The eight trunk interfaces provided by the DXUT card connect to conventional, 2-wire (tip and ring) analog trunk facilities. Incoming analog voice and signaling information from a trunk facility is converted by the DXUT card to digital form and routed to the Meridian 1 common equipment (CE) CPU over DS-30 network loops. Conversely, digital voice and signaling information from the CPU is sent over DS-30 network loops to the DXUT card where it is converted to analog form and applied to the trunk facility.

A separate, dedicated, DS-30X network loop is extended between each IPE line/trunk card and the controller card within an IPE module (or IPE section of a CE/PE module). A DS-30X network loop is composed of two, synchronous, serial data buses. Each bus has a capacity of 32 channels but only 30 are used for Pulse Code Modulated (PCM) voice data. One bus transports in the transmit (Tx) direction towards the trunk facility and the other in the receive (Rx) direction towards Meridian 1 CE. Each channel contains 10 bits. Eight bits are for PCM data and two are call signaling bits.

The eight-bit PCM portion of a channel is called a *timeslot*. The DS-30X loop is clocked at 2.56 Mbps, one-half the 5.12 MHz clock frequency supplied by the controller card. Thus, the timeslot repetition rate for a single channel is 8 kHz. The controller card also supplies a 1 kHz frame sync signal for channel synchronization. The DXUT card uses only eight of the 30 available timeslots for its eight trunk interfaces. The card can be configured in software to format PCM data in the  $\mu$ -law or A-law conventions.



DS-30Y network loops extend between controller cards and superloop network cards in the CE and function in a manner similar to DS-30X loops. Essentially, a DS-30Y loop carries the PCM timeslot traffic of a DS-30X loop. Four DS-30Y network loops form a *superloop* with a capacity of 128 channels (120 usable timeslots). Various superloop configurations exist. See *Meridian 1 system engineering* for more information on superloops.

When the NT5D31AA (DXUT) card is used as an interface to RAN or Paging equipment, additional control lines are provided. For RAN equipment, these lines provide for synchronization of Meridian 1 switching to the playing of recorded announcements. For Paging equipment, the control lines provide for keying of paging amplifiers.

### **Maintenance communications**

Maintenance communications are control and status data that is exchanged between line or trunk cards and the CE CPU by way of the controller card. Maintenance data is transported via the *card LAN* link. This link is composed of two, asynchronous serial buses. Each bus is common to all line/trunk card slots in the IPE module (or IPE section of a CE/PE module) and is arranged in a master/slave configuration. The controller card is the master and all other cards are slaves. The module backplane provides each line/trunk card slot with a unique, hardwired, slot address. A slot address enables a slave card to respond when addressed by the controller card. The controller card communicates with only one slave at a time. One bus is used for output of control data and the other is used for input of status data.

In normal operation, the controller card continually scans (polls) all slave cards connected to the card LAN to monitor their presence and operational status. The slave card sends replies to the controller on the input bus along with its card slot address for identification. In this reply, the slave informs the controller if any change in card status has taken place. The controller can then prompt the slave for specific information. Slaves only respond when prompted by the controller; they do not initiate exchange of control or status data on their own. When the DXUT card is first plugged into the backplane, it runs a self test. When the self test is completed, a properly functioning card will respond to the next controller card poll with the self-test status. The controller will then query for card identification and other status information.

The card LAN link supports the following functions on the DXUT card:

- polling
- reporting of self-test status
- CPU initiated card reset
- reporting of card ID (card type and hardware vintage)
- reporting of firmware version
- downloading trunk interface unit configuration
- reporting of trunk interface unit configuration
- enabling/disabling of the DS-30X network loop bus
- reporting of card status

### **Power requirements**

Power to the NT5D31AA DXUT card is provided by the module power supply (AC or DC). Table 14 lists the power requirements for this card.

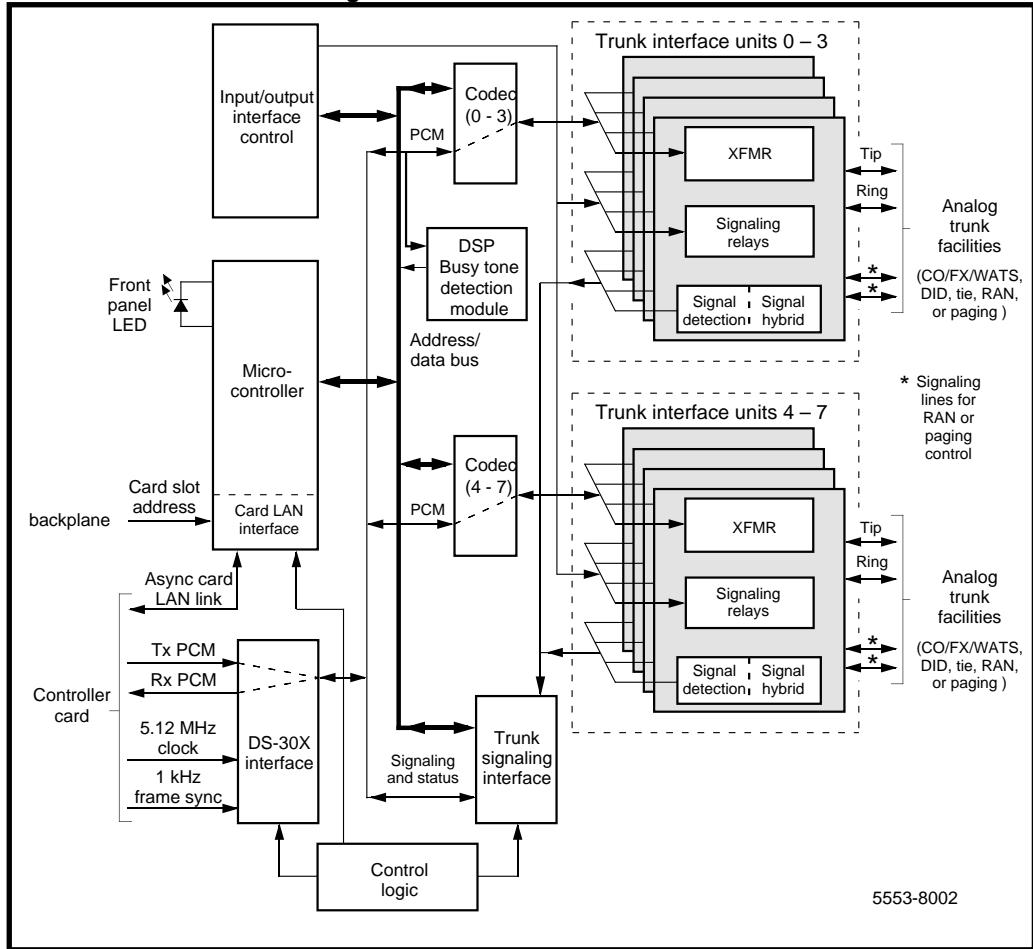
**Table 14**  
**Power requirements**

<b>Voltage</b>	<b>Tolerance</b>	<b>Current (max.)</b>
+15.0 V dc	±5%	450 mA
+5.0 V dc	±2%	250 mA
- 48.0 V dc	±5%	415 mA

### Card functions

Figure 30 shows a block diagram of the major functions contained on the NT5D31AA DXUT card.

**Figure 30**  
**NT5D31 DXUT card - block diagram**



**Trunk interface units**

The NT5D31AA DXUT card contains eight identical and independently configurable trunk interface units (also referred to as circuits). Each unit provides impedance matching and a balance network in a signal transformer/analog hybrid circuit. Also provided are relays for placing outgoing call signaling onto the trunk. Signal detection circuits monitor incoming call signaling. Two codecs are provided for performing A/D and D/A conversion of trunk analog voiceband signals to digital PCM signals. Each codec supports four trunk interface units. The following features are common to all units on the cards:

- trunk type configurable on a per unit basis
- Terminating Impedance (600 or 900 ohm) selectable on a per unit basis
- Balance Impedance (600 or 900 ohm or complex impedance network - 3COM) selectable on a per unit basis. In addition, 3CM2 Balance Impedance option is provided for loaded cables.
- control signals provided for RAN and Paging equipment
- loopback of PCM signals received from trunk facility over DS-30X network loop for diagnostic purposes
- switchable pads for transmission loss control

**Card control functions**

Control functions are provided by a microcontroller, a card LAN interface, and signaling and control circuits on the NT5D31AA DXUT card.

**Microcontroller** - This card contains a microcontroller that controls the internal operation of the card and the serial card LAN link to the controller card. The microcontroller controls the following:

- reporting to the CE CPU via the card LAN link
  - card identification (card type, vintage, and serial number)
  - firmware version
  - self-test status
  - programmed configuration status



- receipt and implementation of card configuration via the card LAN link
  - programming of the codecs
  - enabling/disabling of individual units or entire card
  - programming of input/output interface control circuits for administration of trunk interface unit operation
  - maintenance diagnostics
  - transmission pad settings

**Signaling and control** - The signaling and control portion of the card provides circuits that establish, supervise, and take down call connections. These circuits work with the system CPU to operate trunk interface circuits during calls. The circuits receive outgoing call signaling messages from the CPU and return incoming call status information over the DS-30X network loop.

## Unit configuration

The following functionalities are selected by software service change entries at the system terminal and by jumper strap settings on the card:

- trunk type for each unit on the card
- termination impedance
- balance impedance
- incoming or incoming and outgoing call direction
- tone frequencies
- cadence
- tone levels

## Jumper strap settings

For most applications, the jumper strap settings remain set to the standard configuration as shipped from the factory as described in Table 15.

For CO/FEX/WATS or TIE trunk loops exceeding 762 meters (2500 ft), DID trunks exceeding a loop resistance of 600 ohms, or RAN trunks operating in pulse start or level start modes, the jumper strap settings must be changed as shown in Table 16. Figure 31 shows jumper locations on the DXUT card.

In the rare case where loaded cable is used in the facility, 3CM2 balance termination is recommended. Software setup in Overlay 14 is also required.

*Note:* Refer to *Circuit card installation and testing* for further information regarding jumper strap settings.

## Service change entries

Trunk type, terminating impedance, and balance network are selected by service change entries in the Trunk Administration program (Overlay 14). Refer to Table 17 to select the proper values for the trunk type and loop length being employed. Refer to the *Meridian 1 X11 input/output guide* for Overlay14 service change instructions.

Before the appropriate balance network can be selected, the loop length between the near end (Meridian 1) and the far end (a Central Office, for example) must be known. To assist in determining loop length, some typical

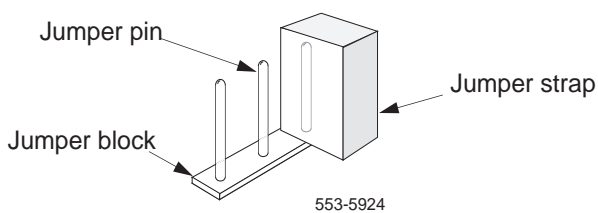
resistance and loss values for the most common cable lengths are given in Table 18 for comparison with values obtained from actual measurements.

Cadence, tone frequencies, and tone levels are selected by service change entries in Overlay 97.

**Table 15**  
**Jumper strap settings – factory standard (NT5D31AA)**

Trunk types	Loop length	Jumper strap settings			
		J1.X	J2.X	J3.X	J4.X
CO/FEX/WATS	Zero – 1524 m (5000 ft)	Off	Off	1-2	Off
2-way TIE (LDR)					
2-way TIE (OAID)					
DID	Zero – 600 ohms				
RAN: continuous operation mode					
Paging					

**Note 1:** Jumper strap settings J1.X, J2.X, J3.X, and J4.X apply to all eight units; “X” indicates the unit number, 0–7. “Off” indicates that no jumper strap is installed on a jumper block. Store unused straps on the DXUT card by installing them on a single jumper pin as shown below:

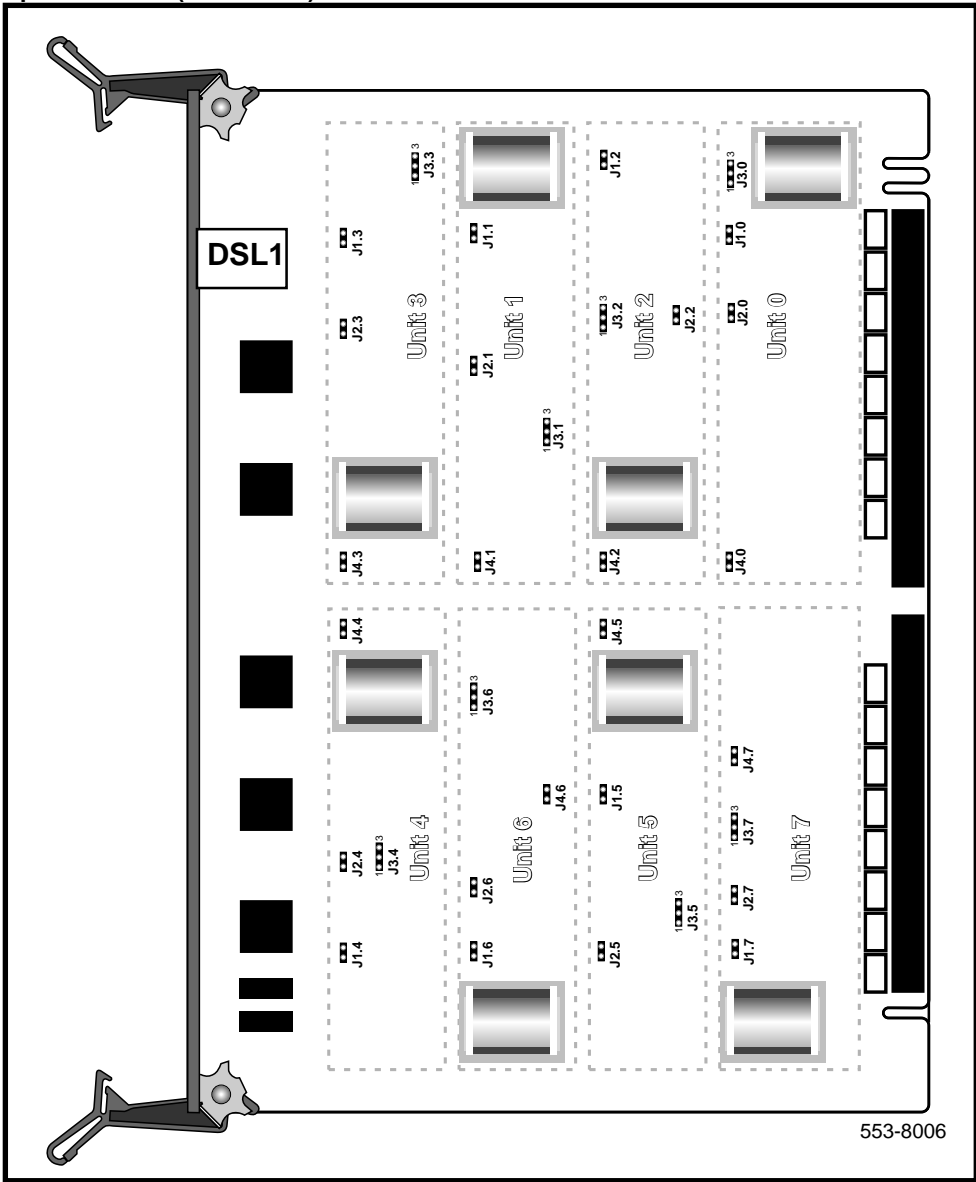


**Note 2:** Jumper blocks labelled P1,P2, P28-P34 are used for testing and future options only and all straps associated with the “P” labelled jumper blocks are open at all times.

**Table 16**  
**Jumper strap settings – extended range (NT5D31AA)**

Trunk types	Loop length	Jumper strap settings			
		J1.X	J2.X	J3.X	J4.X
CO/FEX/WATS	> 1524 m (5000 ft)	Off	Off	1-2	Off
2-way TIE (LDR)					
2-way TIE (OAID)					
DID	> 600 ohms	On	On	1-2	Off
RAN: pulse start or level start modes		Off	Off	2-3	Off
<p><b>Note 1:</b> Jumper strap settings J1.X, J2.X, J3.X, and J4.X apply to all eight units; “X” indicates the unit number, 0–7. “Off” indicates that no jumper strap is installed on a jumper block.</p> <p><b>Note 2:</b> Jumper blocks labelled P1,P2, P28-P34 are used for testing and future options only and all straps associated with the “P” labelled jumper blocks are open at all times.</p>					

Figure 31  
Jumper locations (NT5D31AA)



**Table 17**  
**Trunk types – termination impedance and balance network (NT5D31AA)**

Trunk types	Terminating impedance (Note 1)	Balance network for loop lengths (Note 2)		
		Zero –762 m (zero – 2500ft)	> 762 m (>2500 ft)	For Loaded Cable
CO/FEX/WATS	600 Ω	600 Ω	3COM	3CM2
2-way TIE (LDR)	600 Ω	600 Ω	3COM	3CM2
2-way TIE (OAID)	600 Ω	600 Ω	3COM	3CM2
DID (loop < 600 Ω)	600 Ω	600 Ω	3COM	3CM2
DID (loop ≥ 600 Ω)	600 Ω	600 Ω	3COM	3CM2
RAN: continuous operation mode	600 Ω or 900 Ω	600 Ω or 900 Ω	N/A	N/A
Paging	600 Ω	600 Ω	N/A	N/A

**Note 1:** The terminating impedance of each trunk unit is software selectable in LD 14 and should match the nominal impedance of the connecting equipment.

**Note 2:** The balance network of each trunk unit is software selectable between resistive 600 or 900 Ω or 3COM or 3CM2.

**Table 18**  
**Cable loop resistance and loss**

Cable length	Cable loop resistance (ohms)			Cable loop loss (dB) (non-loaded at 1kHz)		
	22 AWG	24 AWG	26 AWG	22 AWG	24 AWG	26 AWG
915 m (3000 ft)	97	155	251	0.9	1.2	1.5
1524 m (5000 ft)	162	260	417	1.6	2.0	2.5
2225 m (7300 ft)	236	378	609	2.3	3.0	3.7
3566 m (11700 ft)	379	607	977	3.7	4.8	6.0
5639 m (18500 ft)	600	960	1544	5.9	7.6	9.4

## Port-to-port loss configuration

The NT5D31AA DXUT provides pad switching for control of end-to-end connection loss. Control of loss is a major element in controlling transmission performance parameters such as received volume, echo, noise, and crosstalk.

The transmission properties of each trunk unit are characterized by the Class of Service (CLS) assigned in the Trunk Administration program (Overlay 14) and the far-end port type (PTY) in the Trunk Route Administration program (Overlay 16). A complete loss plan is given in *Summary of transmission parameters* where the appropriate port-to-port electrical loss may be determined for connections between any two Meridian 1 ports (lines, analog trunks, or digital trunks).

## Electrical specifications

Table 19 gives the electrical characteristics of the DXUT card.

**Table 19**  
**Electrical characteristics for the NT5D31AA**

Characteristic	CO/FEX/WATS trunks	DID or TIE trunks	RAN trunks	Paging trunks
Terminal impedance	600 $\Omega$ or 900 $\Omega$ (Note 1)		600 $\Omega$ / 900 $\Omega$ (Note 1)	600 $\Omega$
Balance impedance	600 $\Omega$ or 900 $\Omega$ , 3COM, or 3CM2 (Note 1)		N/A	N/A
Supervision type	Ground or loop start (with BT sup) (Note 2)	Loop start	Continuous, level, or pulse	N/A
DC signaling loop length (max)	1700 $\Omega$ loop with near-end battery of -42.75 V	2450 $\Omega$ loop with near-end battery of -44 V	600 $\Omega$ /900 $\Omega$ loop	600 $\Omega$ loop
Far-end battery	-42 to -52.5 V (Note 3)	-42 to -52.5 V	-42 to -52 V	N/A
Minimum detected loop current	20 mA	10 mA	10 mA	N/A
Ground potential difference	$\pm 3$ V		$\pm 1$ V	$\pm 1$ V
Low DC loop resistance during outpulsing	<300 $\Omega$	N/A	N/A	N/A
High DC loop resistance	Ground start $\geq 30$ K $\Omega$ ; loop start $\geq 5$ M $\Omega$	N/A	N/A	N/A
Ring detection	17 to 33 Hz 40 to 120 V rms	N/A	N/A	N/A
Line leakage	$\geq 30$ K $\Omega$ , tip-to-ring, tip-to-ground, ring-to-ground		N/A	N/A
AC induction rejection	10 V rms, tip-to-ring, tip-to-ground, ring-to-ground		N/A	N/A
<b>Note 1:</b> Selected in software.				
<b>Note 2:</b> Loop start with Busy Tone Disconnect Supervision introduced with minimum Release 23 software.				
<b>Note 3:</b> For loop extender application, the maximum voltage applied between tip and ring is -105 V $\pm 5\%$ . The minimum DC loop resistance for this type of application is 1800 $\Omega$ .				



## Environmental specifications

Table 20 lists the environmental specifications for the DXUT card.

**Table 20**  
**Environmental specifications for the NT5D31AA**

Parameter	Specifications
Operating temperature	0° to +60° C (+32 to +140° F), ambient
Operating humidity	5 to 95% RH (non-condensing)
Storage temperature	-40° to +70° C (-40° to +158° F)

## Foreign and surge voltage protection

The NT5D31AA DXUT card meets UL-1489 and CS03 over-voltage (power cross) specifications and FCC Part 68 requirements.

## Operation

The optional applications, features, and signaling arrangements for each unit on the NT5D31AA DXUT card is assigned through the Trunk Administration (Overlay 14), and Trunk Route Administration (Overlay 16) programs and/or jumper strap settings on the cards. See the *X11 input/output guide* for detailed information on assigning features and services to trunks.

COT Loop start signaling requires that Busy Tone Detection be configured in software Overlay 97 prior to the configuration of Overlays 16 and 14.

## Loop start operation

Loop start operation is configured in software and is implemented in the card through software download messages. When the DXUT card is idle, it provides a high impedance toward the CO for isolation and AC (ringing) detection.

### Incoming calls

The CO sends an alerting signal of 20 Hz (nominal) to the Meridian 1 system. Ringing is tripped when this trunk circuit places a low resistance DC loop towards the CO when an attendant is available. Figures 32 and 33 illustrate this process.

### Outgoing calls

For outgoing calls from the Meridian 1, software sends an outgoing seizure message to place a low-resistance loop across the tip and ring leads towards the CO (see Figures 34 and 35). When the CO detects the low-resistance loop, it prepares to receive digits. When the CO is ready to receive digits, it returns dial tone. Outward address signaling is then applied from the Meridian 1 in the form of loop (interrupting) dial pulses or DTMF tones.

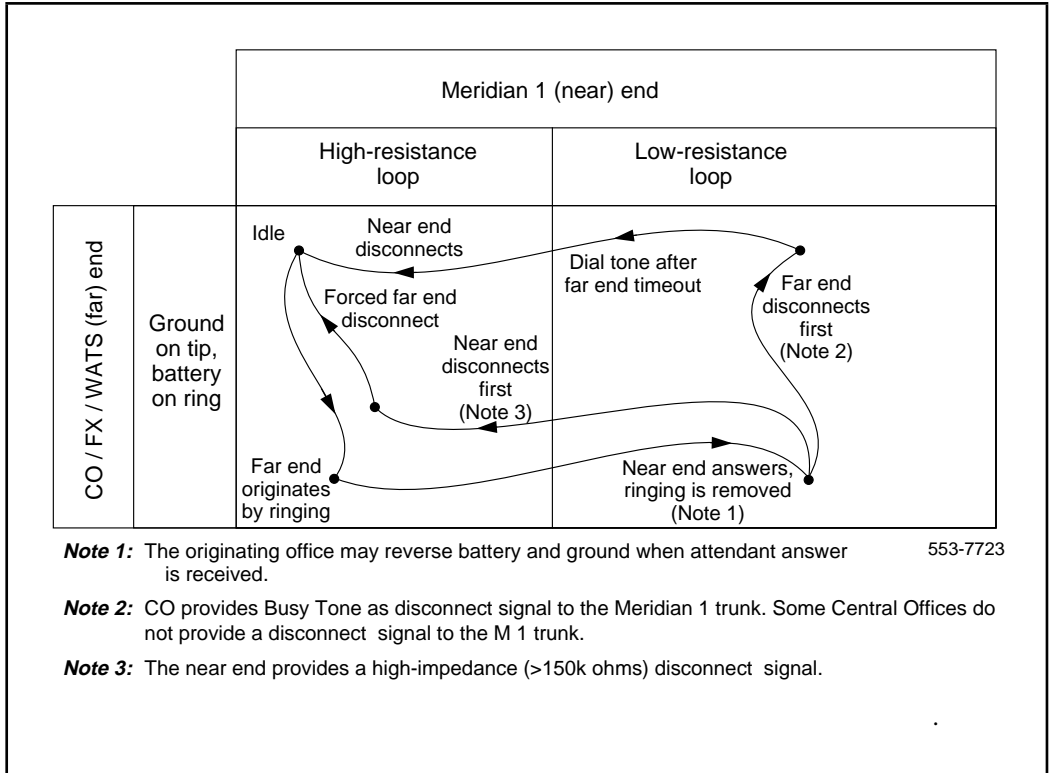
### **Polarity-sensitive/-insensitive packs feature**

The Meridian 1 software provides the “polarity-sensitive/-insensitive packs” (PSP and PIP) feature for the accurate recording of outgoing call duration for loop start and ground start operation. On trunks equipped with far-end answer supervision, the PSP Class of Service is enabled in software and causes call-duration recording in CDR records to begin only upon receipt of answer supervision from the far end. For trunks not equipped with answer supervision, the PIP Class of Service is enabled and call-duration recording begins immediately upon near-end trunk seizure. The PSP and PIP Classes of Service are enabled in the Trunk Administration program (Overlay 14).

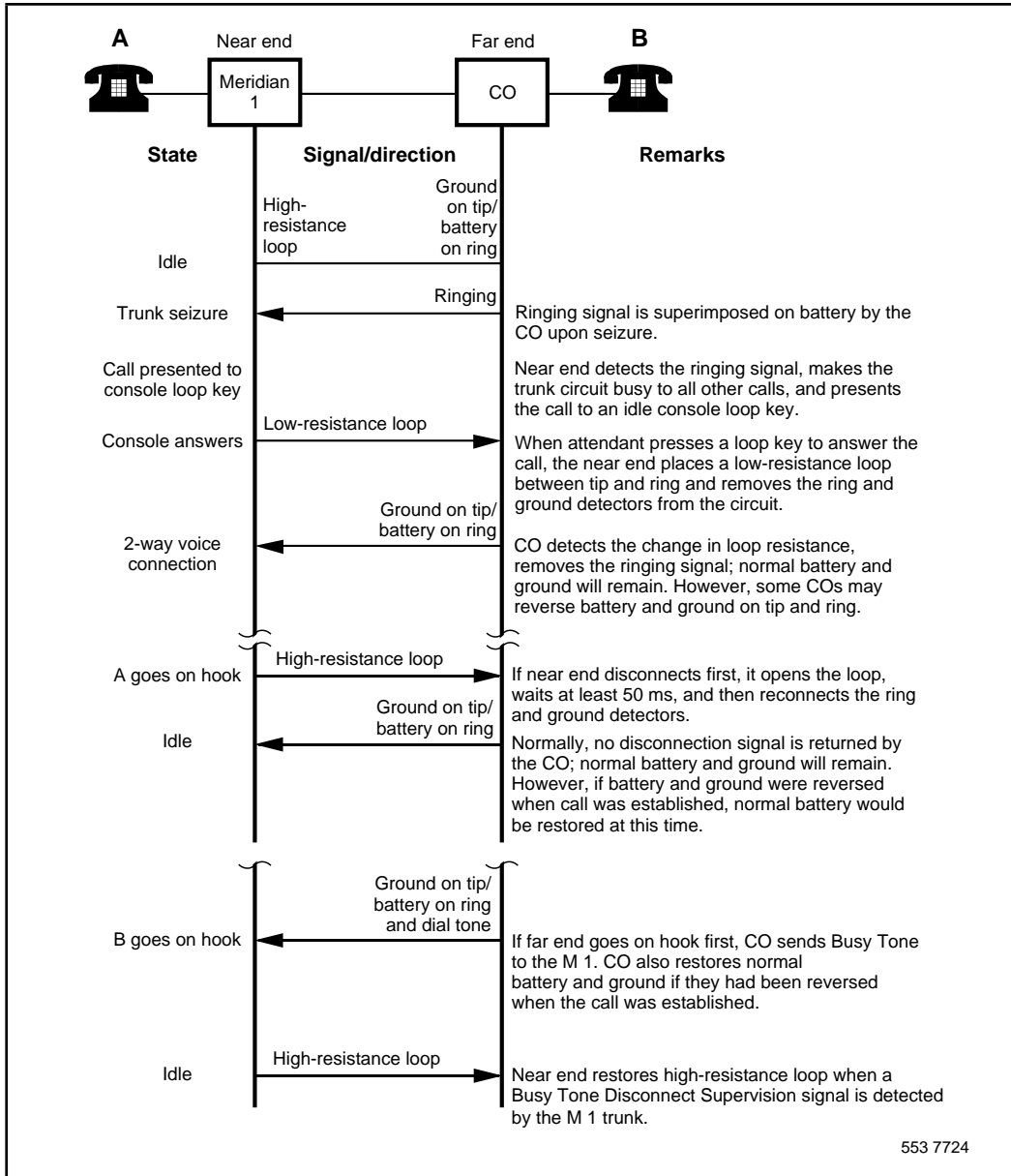
### **Far end release**

If Busy Tone Disconnect Supervision is configured, upon receipt of a busy tone signal from the far end the DXUT trunk will send a busy tone detected message to software. The software will then send a disconnect message to idle the trunk.

**Figure 32**  
**Loop start call states – incoming call from CO/FEX/WATS**

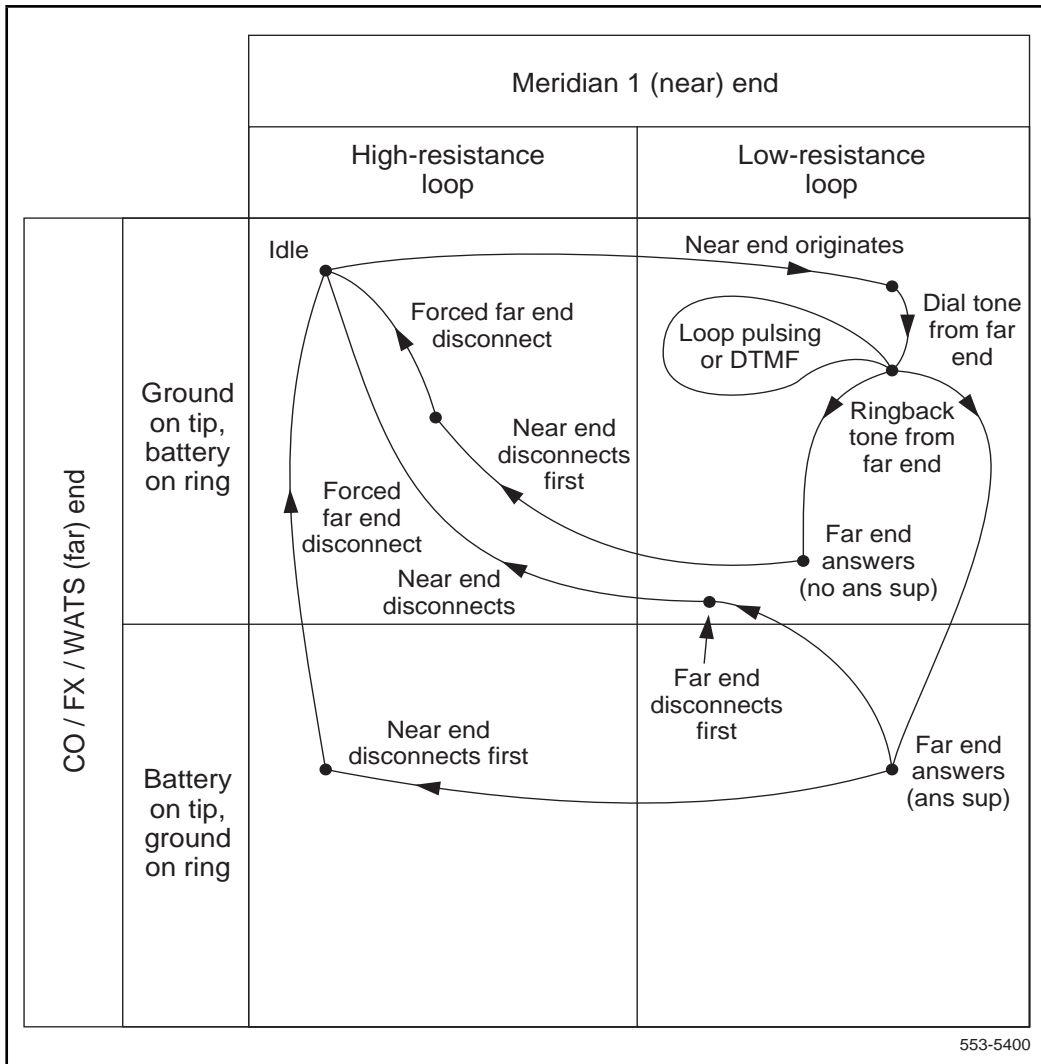


**Figure 33**  
**Loop start call connection sequence – incoming call from CO/FEX/WATS**

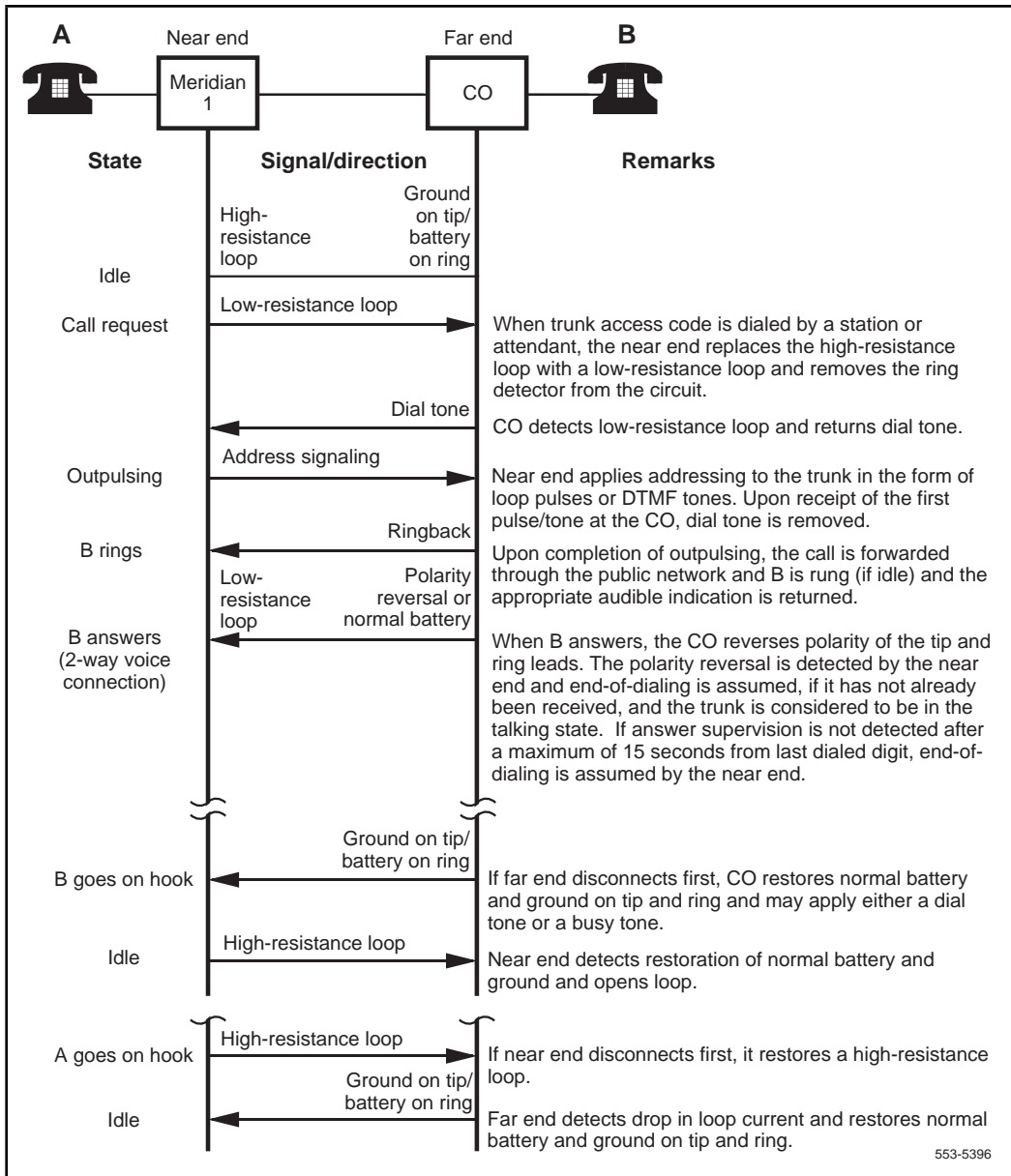


553 7724

**Figure 34**  
**Loop start call states – outgoing call to CO/FX/WATS**



**Figure 35**  
**Loop start call connection sequence – outgoing call to CO/FEX/WATS**



553-5396

## Busy Tone Detection

The Busy Tone Detection feature is provided by the NT5D31AA DXUT card. This feature requires the Busy Tone Detection (BTD) software package 294.

Busy Tone Detection resolves the supervision problem that occurs when the Meridian 1 system receives calls from an unsupervised loop start trunk. When these incoming calls are connected to a device such as Meridian Mail, and are subsequently disconnected, the Meridian 1 system is not informed and the trunk is held up unnecessarily. Busy Tone Detection notifies the Meridian 1 system that the CO end has disconnected. The Meridian 1 trunk is subsequently restored to an idle state.

The NT5D31AA DXUT card can be configured to support

- Busy Tone Disconnect Supervision for incoming calls only
- Busy Tone Disconnect Supervision for both incoming/outgoing calls
- Flexible tone frequencies
- Flexible cadence detection
- Flexible tone levels

Busy Tone Detection can be applied on a per channel basis. The NT5D31AA DXUT card uses Digital Signal Processing (DSP) to implement the Busy Tone Detection functionality for loop start trunks. The DSP based trunk card can detect a *single* frequency busy tone and busy tones made up of *dual* frequencies. The various Busy Tone Detection parameters are programmed in Overlay 97 and are applicable on a per card basis only. The following aspects of the DXUT card are programmable:

- Center frequency of the busy tone, within the range of 350 to 665 Hz in increments of 5 Hz. The tolerance of the center frequency is  $\pm 25$  Hz.
- Cadence ON/OFF duration, within the range of 0 to 1500 ms in increments of 25 ms.
- Maximum Level of detection, within the range of 0 dBm to -15 dBm in increments of 5 dB.
- Minimum Level of detection, within the range of -20 dBm to -35 dBm in increments of 5 dB.



The DXUT card can be plugged into any one of the peripheral card slots in the IPE backplane of a Meridian 1. In the loop start trunk mode, both Reverse Battery and Busy Tone Disconnect Supervision are supported by the card. For Busy Tone Disconnect Supervision, the NT5D31AA card can be configured to support the following options:

- Busy Tone Disconnect Supervision for Incoming Calls only.
- Busy Tone Disconnect Supervision for **both** Incoming/Outgoing Calls.

When busy tone is detected by the DSP tone detector, the tone burst frequency or frequencies (for dual tone), cadences, and level are checked for validity before reporting to the Meridian 1 system CPU through the microcontroller.

### **International busy tone characteristics for reference**

For reference purposes only, the data provided in Table 21 defines the busy tone characteristics of various countries.

The DXUT card is not guaranteed to support Busy Tone Detection in all of the countries listed in Table 21, unless otherwise stated. It is advised that customers consult their local telephone company to confirm their area's busy tone characteristics before putting the DXUT card into service.

**Table 21**  
**Busy tone characteristics of different countries (Part 1 of 2)**

Country	BT Frequency (Hz)	BT Cadence (ms)	BT Level (dBm)
Mexico	425 +/- 25	250 on/off	-30
Brazil	425 +/- 25	250 on/off	-30
Tortola	480 & 620	250 on/off	-30
Venezuela	450 +/- 10	500 on/off	-10
Chile	400 +/- 10	500 on/off	TBD
Argentina	425 +/- 10	TBD	TBD
Uruguay	425 +/- 10	500 on/off	TBD
Colombia	425	250 on/off	-10
Australia	425 +/- 10	375 on/off	-17
Japan	400 +/- 10	350 on/off	-10/-30
China	450	700 on/off	-10/-30
Malaysia	425	500 on/off	-12
Singapore	425	750 on/off	-10 at CO's MDF
Thailand	400	500 on/off	-5/-15
Indonesia	425 +/- 25	500 on/off	-9 +/- 2.5
Taiwan	480 & 620	250 on/off	-24
Hong Kong	480 & 620	500 on/off	-16 +/- 1 at CO's MDF
Korea	480 & 620	500 on/off & 300 on/200 off	TBD
Philippines	480 & 620	500 on/off	-5 dBm 0
Pakistan	450	250 on/350 off	-10
India	400	750 on/off	-10 +/- 5 dBm 0 at CO's MDF
New Zealand	400	500 on/500 off	TBD
Ireland	425 +/-5	370 on/off	-12.5

**Table 21**  
**Busy tone characteristics of different countries (Part 2 of 2)**

Country	BT Frequency (Hz)	BT Cadence (ms)	BT Level (dBm)
Germany	435 +/- 55	TBD	-35
Norway	425 +/- 15	250 on/off	-30
Switzerland	425	200 on/off	-16
Holland	445	225 +/- 75 on/off	TBD
Denmark	425 +/- 25	250 +/- 25 on/off	-30 to -5
Italy	425	200 +/- 40 on/off	-30 to -5

## Trunk configuration for loop start operation

Busy Tone Detection for loop start signaling is configured in software through Overlay 97, Overlay 16, and Overlay 14.

### Busy Tone Detection (BTD) Data Block

Busy Tone Detection is configured in LD 97, as described in Table 22.

**Table 22**  
**LD 97 – Busy Tone Detection Data Block**

Prompt	Response	Comments
REQ	CHG	Modify existing data
TYPE	BTD	Busy Tone Detection
BTDT	(0)-7	Busy Tone Detection Table
BCAD	(350) (350)	Busy Tone Cadence (in milliseconds) (ON cycle) (OFF cycle)
	500 500	For Japan
BTDD	(BOTH)	Busy Tone Detection on both incoming and outgoing calls (default)
	INC	Busy Tone Detection on incoming calls only
FREQ_0	350 - 655	Frequency of busy tone for Frequency 0 of a dual Busy Tone Detection to be detected in Hz. Valid entries are in multiples of 5Hz.
FREQ_1	350 - 655	Frequency of busy tone for Frequency 1 of a dual Busy Tone Detection to be detected in Hz. Valid entries are in multiples of 5Hz.
		For a single busy tone FREQ_1 must be set the same as FREQ_0.
FDLT	10 - 315	Frequency Delta. (Currently this feature is NOT in use. Any entry in this field is ignored by the software.)  FDLT gives the tolerance of the tone to be detected in +/- hertz. Valid entries are in multiples of 5Hz.  For dual Busy Tone Detection on the NT5D31 card, the same frequency delta applies to both tones.

FLVL_MAX	0 - 15	Maximum Frequency Tone level to be detected in dBm. Valid entries are in multiples of 5dBm. For dual Busy Tone Detection on the NT5D31 card, the same level applies to both tones.
FLVL_MIN	20 - 35	Minimum Frequency Tone level to be detected in dBm. Valid entries are in multiples of 5dBm. For dual Busy Tone Detection on the NT5D31 card, the same level applies to both tones.

**Route Data Block**

Each trunk unit on the NT5D31AA DXUT card is attached to a route with an associated Route Data Block. Trunk timers are configured on a route basis. The Route Data Block is programmed in LD 16, as described in Table 23.

**Table 23**  
**LD 16 – Route Data Block**

Prompt	Response	Comments
REQ	NEW	Add a new data block to the system
TYPE	RDB	Define a new Route Data Block
CUST	xx	Enter customer number
ROUT	0-511 0-127	Enter route number For Option 11C
TKTP	COT	Define trunk type as Central Office
ICOG	IAO	Incoming and Outgoing trunk
CNTL	YES	Changes to controls or timers
NEDC	ETH	Either end control
FEDC	ETH	Either end control

**Trunk Data Block**

Use LD 14 to configure each of the trunk units on the NT5D31AA DXUT card, as described in Table 24.

**Table 24**  
**LD 14 – Trunk Data Block**

Prompt	Response	Comments
REQ	NEW	Define a new trunk unit
TYPE	COT	Central Office Trunk data block
TN	l s c u c u	Terminal number of the unit For Option 11C
XTRK	EXUT	Type is IPE EXUT. This includes the DXUT. (This prompt is required only for the first unit defined on each card.)
SIGL	LOP	Loop Start signaling
TIMP		Termination impedance
	(600) 900	
BIMP		Balance impedance
	(3COM) 600 3CM2 900	
AUTO_BIMP	YES	Auto Balance impedance. (Currently this feature is NOT in use. Any entry in this field is ignored by the DXUT.)
SUPN	YES	Answer and disconnect supervision required
-STYP		Supervision Type
	PIP	Polarity Insensitive Pack
	BTS	Busy Tone Supervision
	PIP BTS	Both options
BTDT	(0)-7	Busy Tone Detection Table (This prompt is required only for the first unit defined on each card.)
CLS	(DIP) DTN	Dial Pulse Digitone

## Ground start operation

Ground start operation is configured in software and implemented through software download messages. In the idle state, the tip conductor from the CO is open and a high-resistance negative battery is present on the ring lead.

For configuration requirements, refer to the *Meridian 1 X11 input/output guide* and *Circuit Card Installation and Testing*.

## Incoming calls

In an incoming call, after ground is detected on the tip, the DXUT card scans for a ringing detection signal before presenting the call to an attendant and tripping the ringing. When the attendant answers, a low resistance is placed across the tip and ring conductors which trips CO ringing and establishes a speech path (see Figures 36 and 37).

### Reverse-wiring compensation

The Meridian 1 software includes a feature for detecting reverse wiring (connection of near-end tip and ring leads to far-end ring and tip leads, respectively) on ground start trunks with far-end answer supervision.

Ordinarily, an incoming call on a reverse-wired trunk without reverse-wiring compensation will present ringing on the tip lead rather than on the ring lead. Since software expects to see a ground on the tip lead, it will interpret the end of the first ringing signal as a switchhook flash. But since the interval between ringing signals exceeds the switchhook flash time of 512 milliseconds, software assumes far-end disconnect. This causes the call to be presented to a console loop key and then immediately removed.

The reverse-wiring compensation feature operates as follows. If an apparent disconnect takes place immediately after the first ringing signal, the software will time stamp the event and temporarily remove the call from the console loop key. If another such ringing/disconnect event occurs during the No Ringing Detector (NRD) time, the trunk will be considered “*possibly* reverse wired” and a threshold counter will be incremented. Calls on trunks identified as possibly reverse wired will be presented to the attendant during the initial ring, removed and then continuously presented after the second ring. If a call on a possibly reversed wired trunk is abandoned before the attendant answers, it will be disconnected after the NRD timer expires.

Trunks identified as possibly reverse wired will be switched by software to loop start processing after the second ring. This switching takes place on a call-by-call basis. Thus, if a previously correctly wired trunk becomes reverse wired, the next incoming call will be marked as possibly reverse wired and the threshold count will begin.

If the threshold count exceeds its limit, an error message is printed and the trunk is registered as “*positively* reversed wired.” Once identified as positively reversed wired, the call will be presented continuously from the first ring. When a reverse-wired trunk becomes correctly wired, the first subsequent call will clear the threshold counter and normal ground start processing will be implemented.

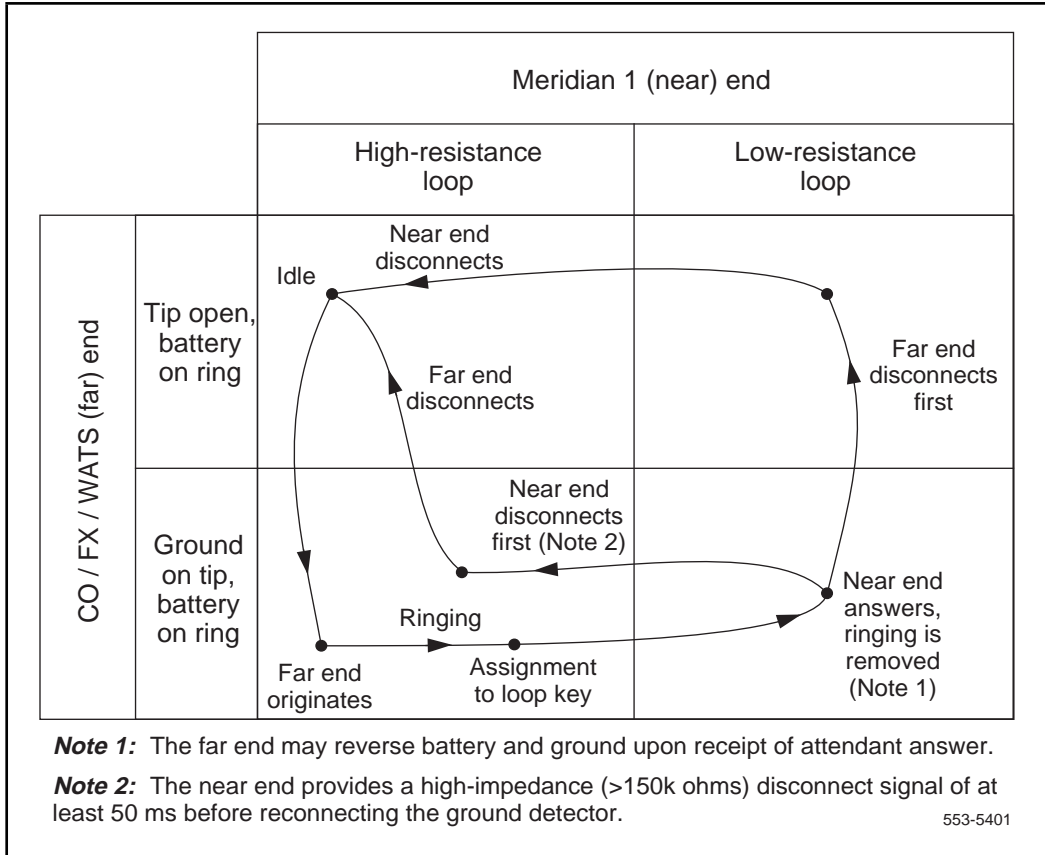
## **Outgoing calls**

For outgoing calls, the trunk provides ground to the ring lead. The CO responds by grounding the tip and returning dial tone. After the tip ground is detected by the card, a low-resistance path is placed between the tip and ring leads and the ground is removed from the ring. Addressing is then applied from the Meridian 1 in the form of loop (interrupting) dial pulses or DTMF tones (see Figures 38 and 39).

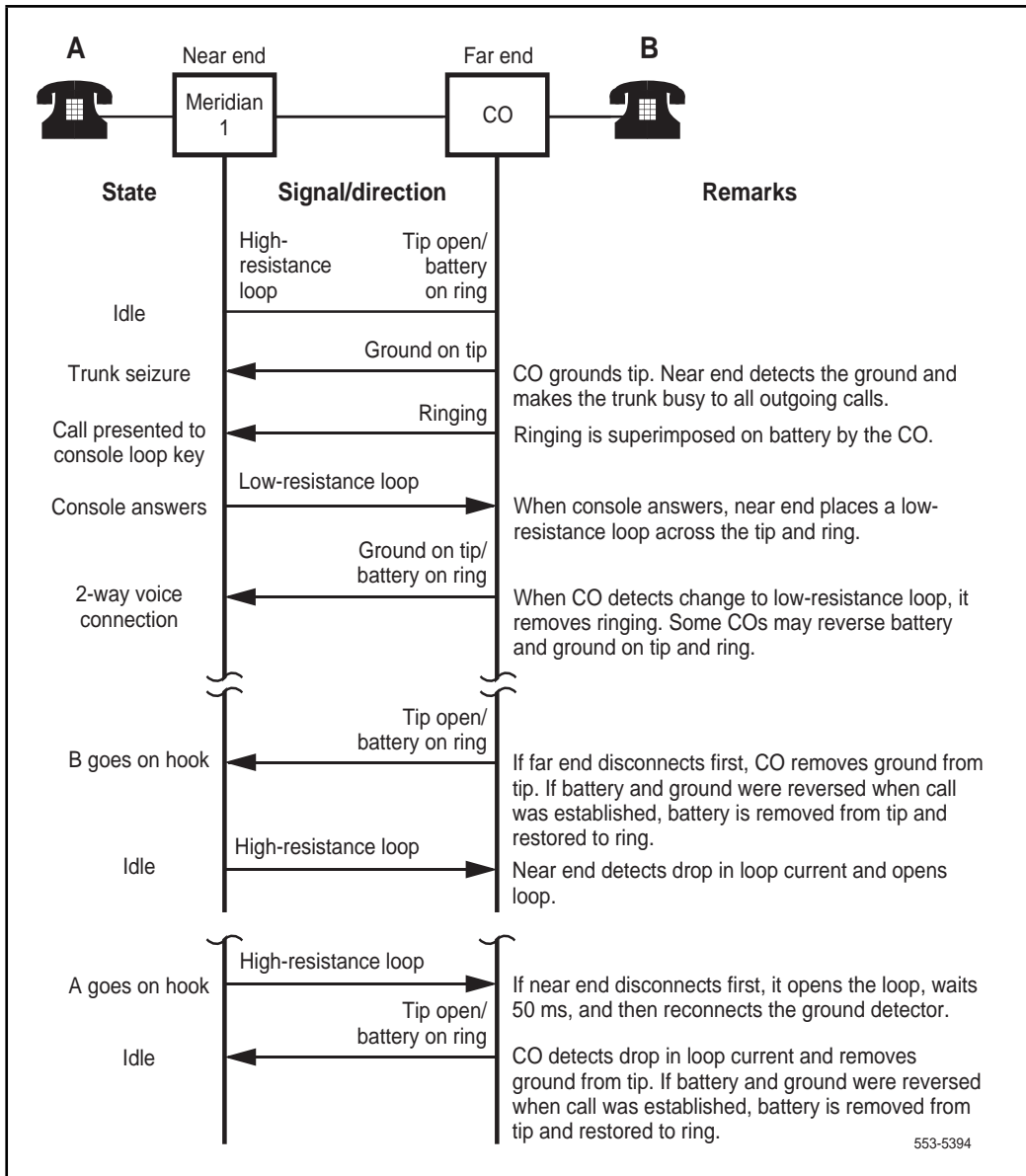
The polarity-sensitive/-insensitive packs (PSP and PIP) feature must be set to provide for proper outgoing call-duration recording with ground start operation. Refer to the description of loop start operation in this section for a more complete discussion of PSP and PIP.



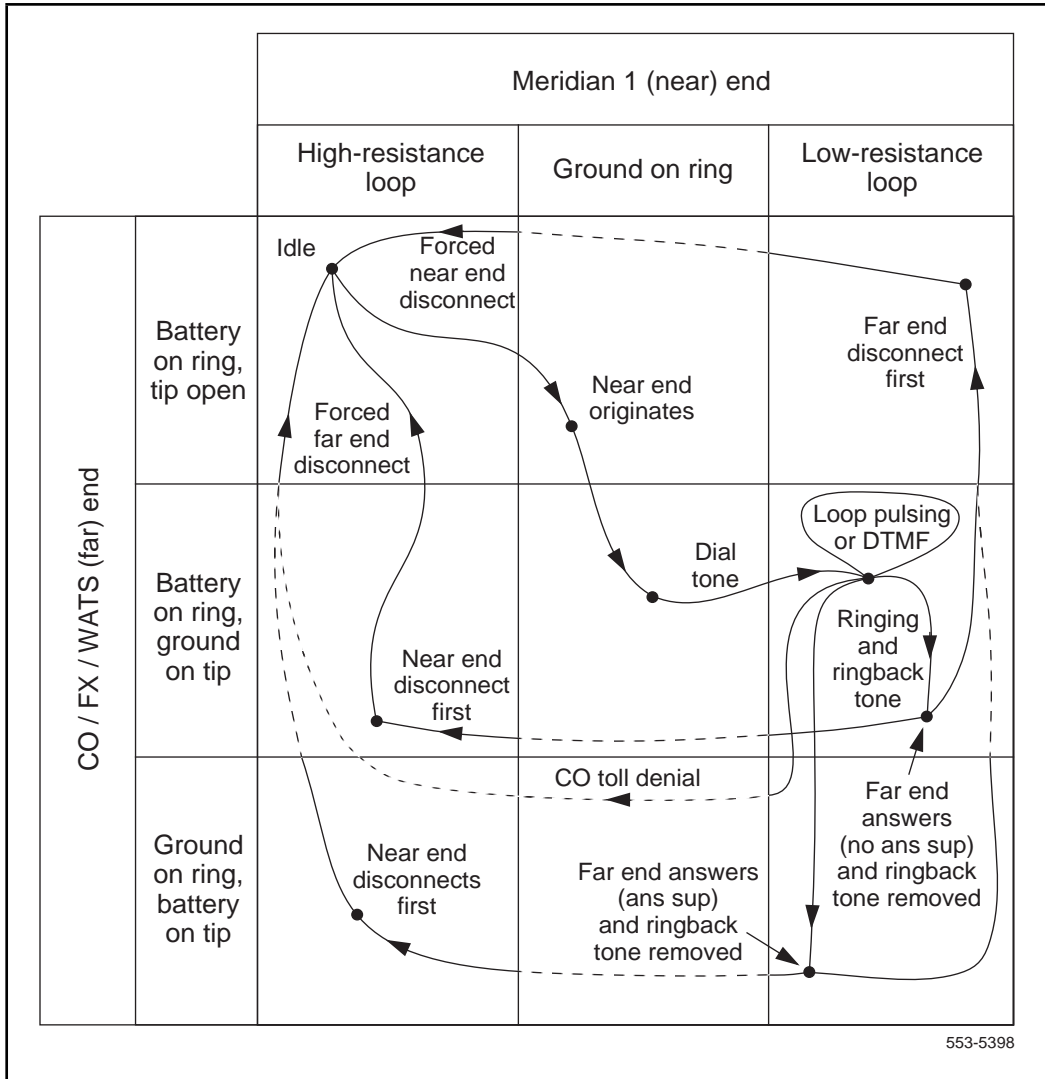
**Figure 36**  
**Ground start call states – incoming call from CO/FEX/WATS**



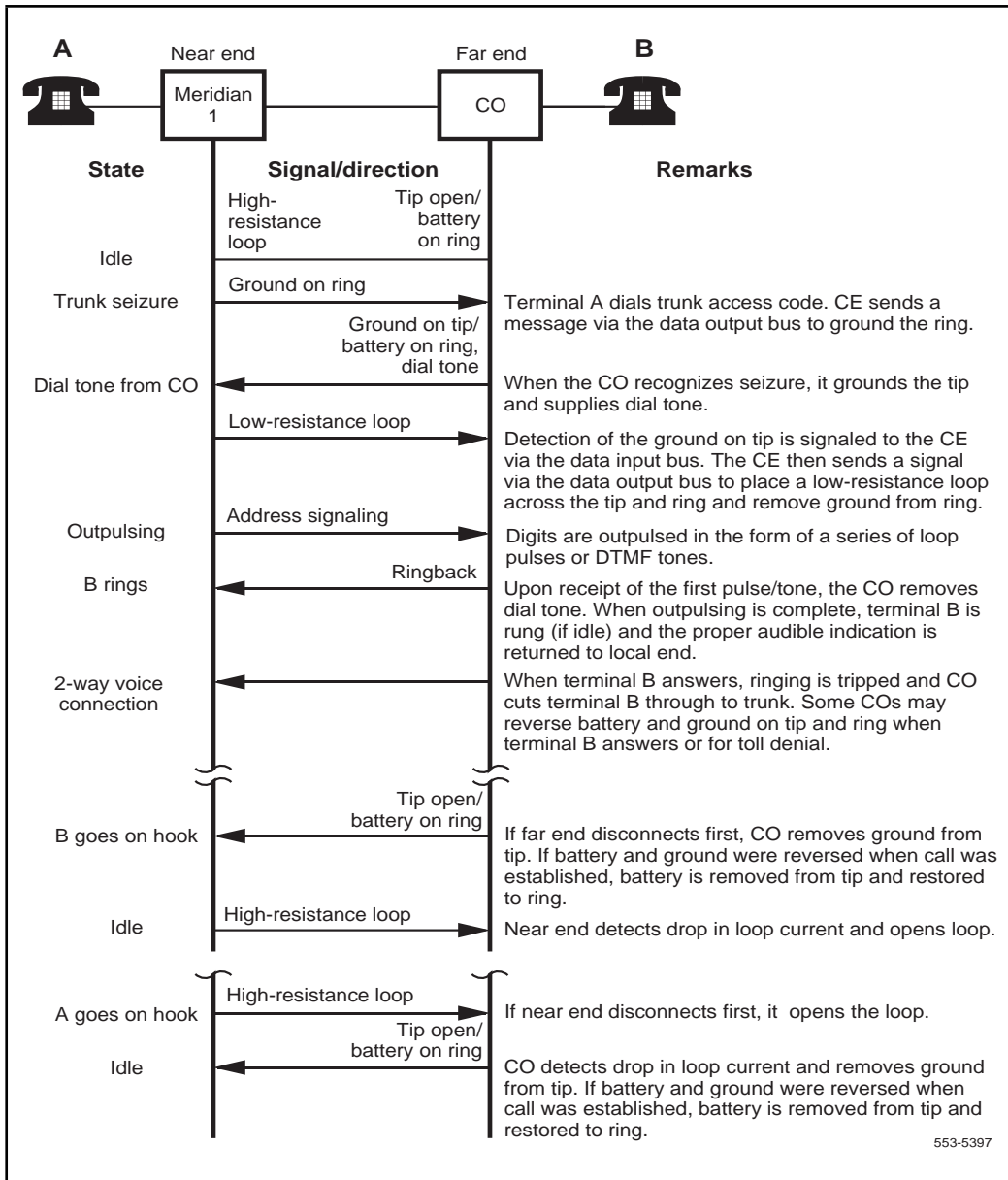
**Figure 37**  
**Ground start call connection sequence – incoming call from CO/FEX/WATS**



**Figure 38**  
**Ground start call states – outgoing call to CO/FEX/WATS**



**Figure 39**  
**Ground start call connection sequence – outgoing call to CO/FEX/WATS**

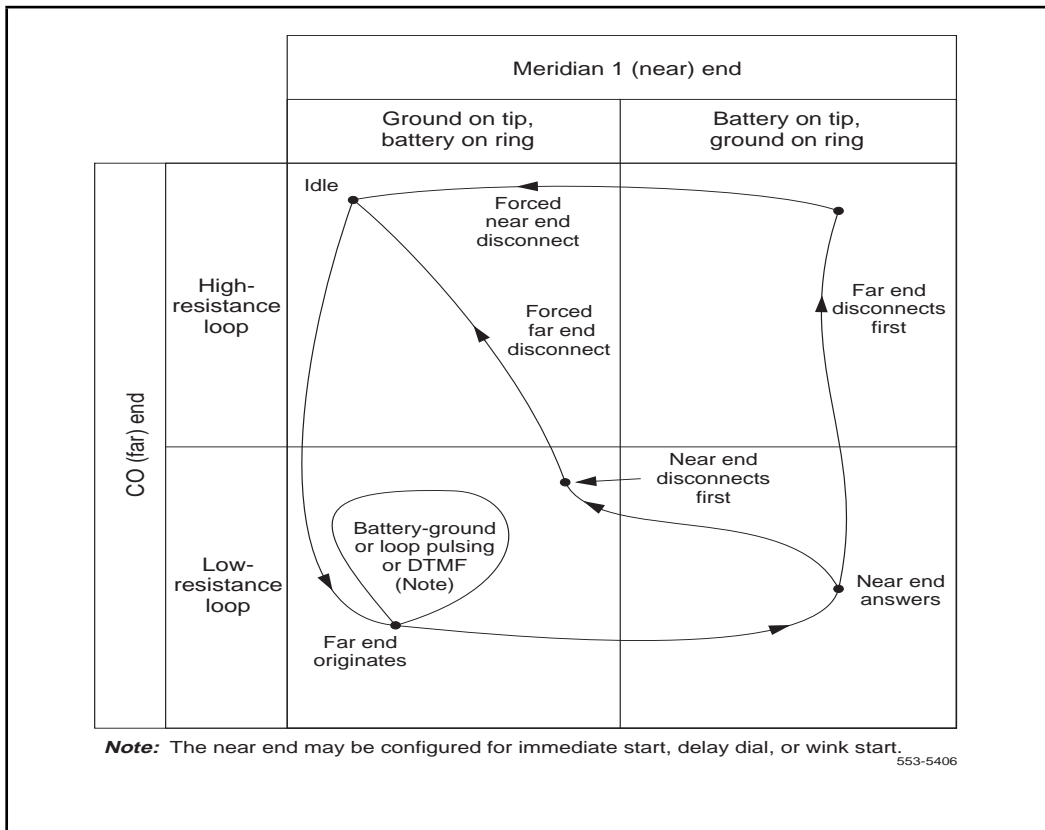


## Direct Inward Dial operation

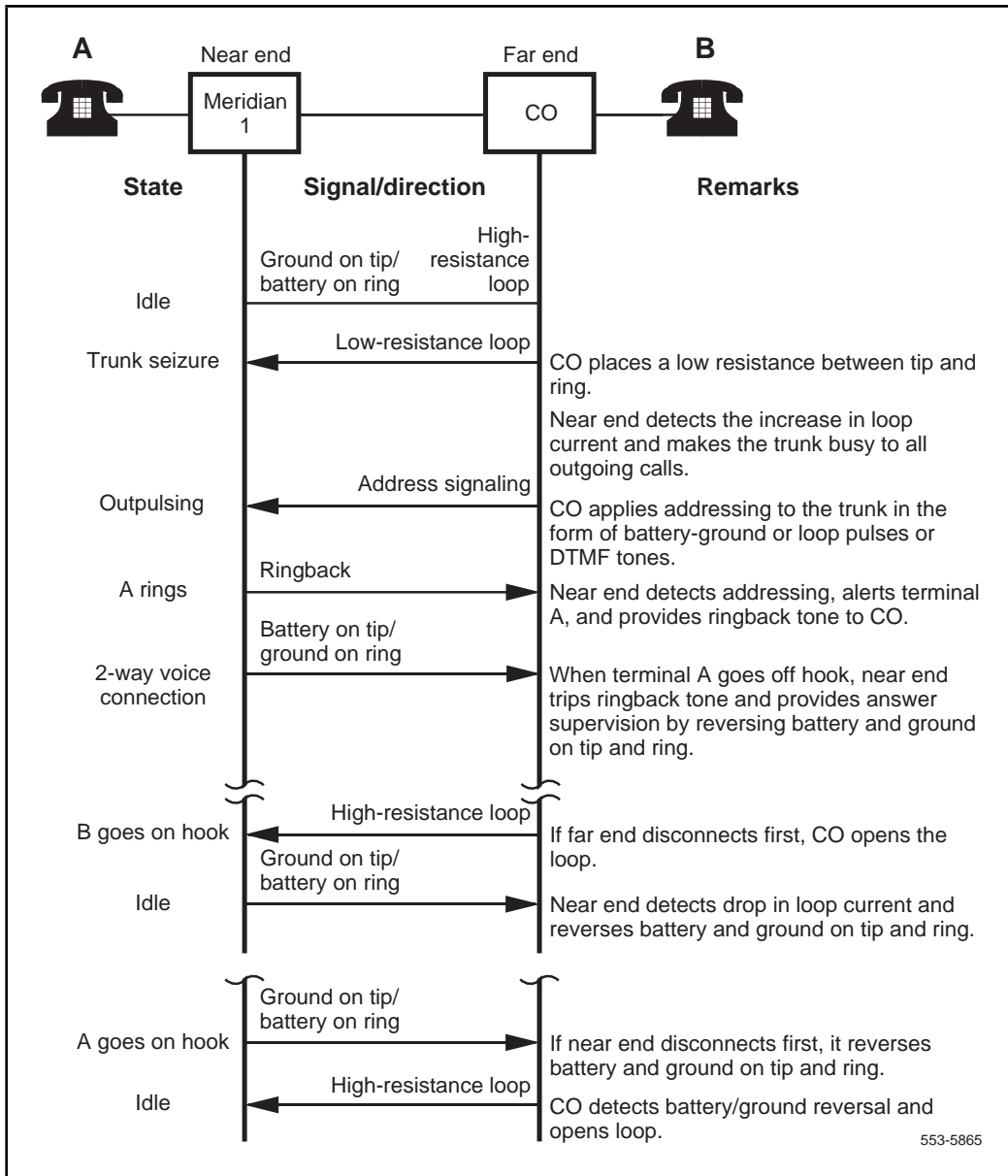
### Incoming calls

An incoming call from the CO places a low-resistance loop across the tip and ring leads (see Figures 40 and 41). Dial pulses or DTMF tones are then presented from the CO. When the called party answers, the DXUT card reverses battery and ground on the tip and ring leads to the CO. The trunk is arranged for first party release. The CO releases the trunk by removing the low-resistance loop, at which time normal battery and ground are restored at the near end. The operation represented in Figures 40 and 41 also applies to incoming TIE trunk calls from a far-end PBX.

**Figure 40**  
**DID trunk, Loop DR call states – incoming call from CO**



**Figure 41**  
**DID trunk, Loop DR call connection sequence – incoming call from CO**



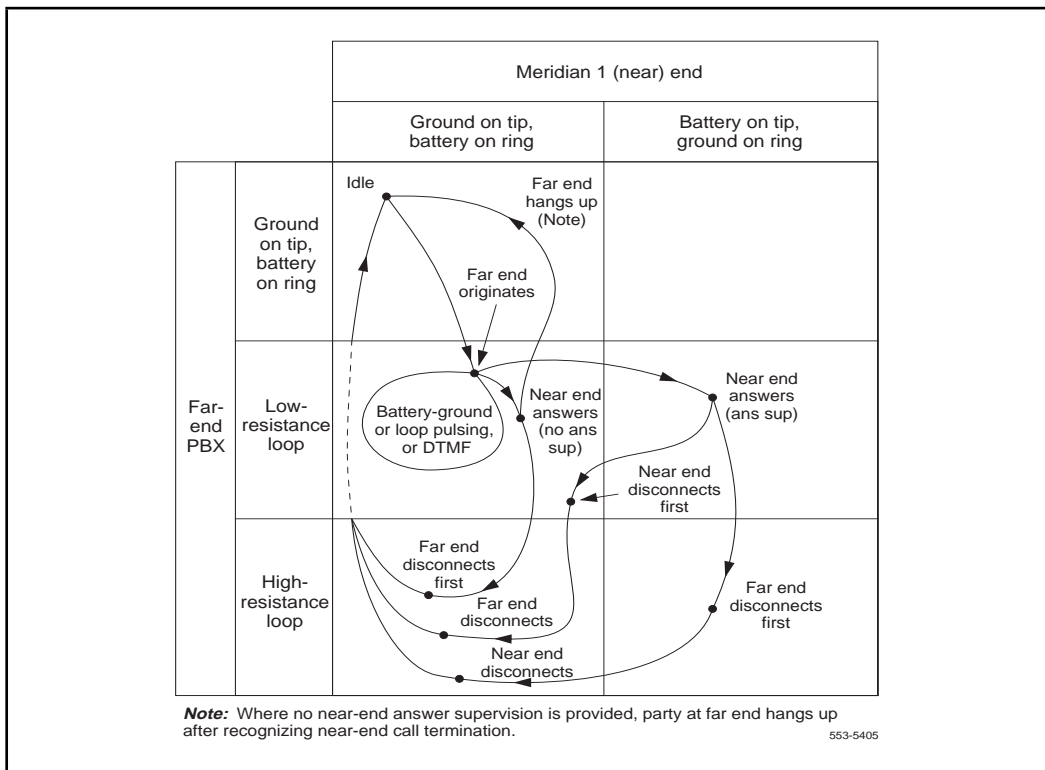
## Two-way, Loop Dial Repeating, TIE trunk operation

### Incoming calls

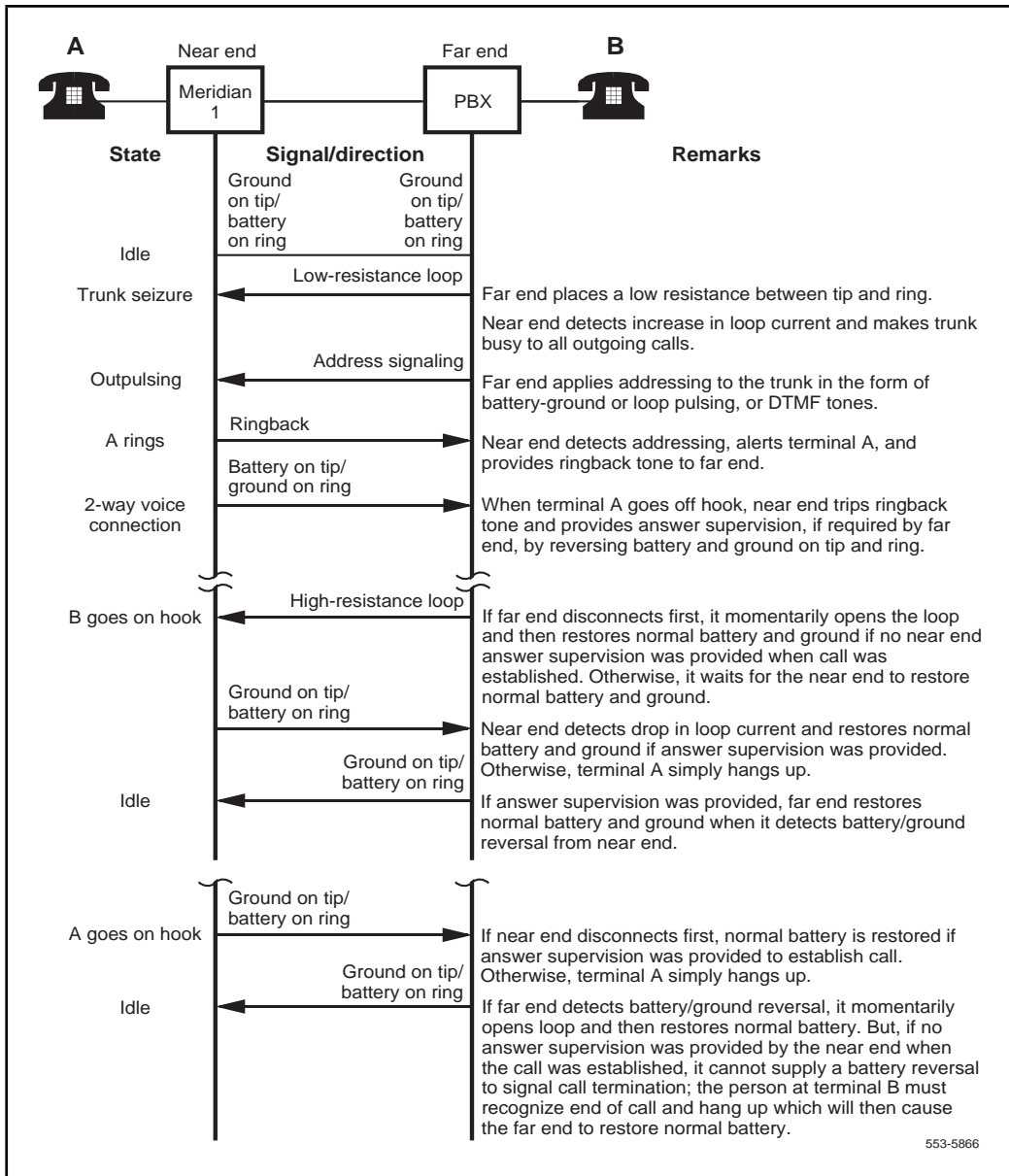
In an incoming call configuration, the far end initiates a call by placing a low-resistance loop across the tip and ring leads (see Figures 42 and 43). This causes a current to flow through the battery feed resistors in the trunk circuit. Address signaling is then applied by the far end in the form of DTMF tones or dial pulses. When the called party answers, an answer supervision signal is sent by software, causing the Meridian 1 to reverse battery and ground on tip and ring to the far end. Far-end disconnect is initiated by opening the loop while near-end disconnect is initiated by restoring normal battery and ground.

The operation represented in Figures 42 and 43 also applies to incoming DID trunk calls from a CO.

**Figure 42**  
Two-way, Loop DR, TIE trunk call states – incoming call from far-end PBX



**Figure 43**  
**Two-way, Loop DR, TIE trunk call connection sequence – incoming call from far-end PBX**

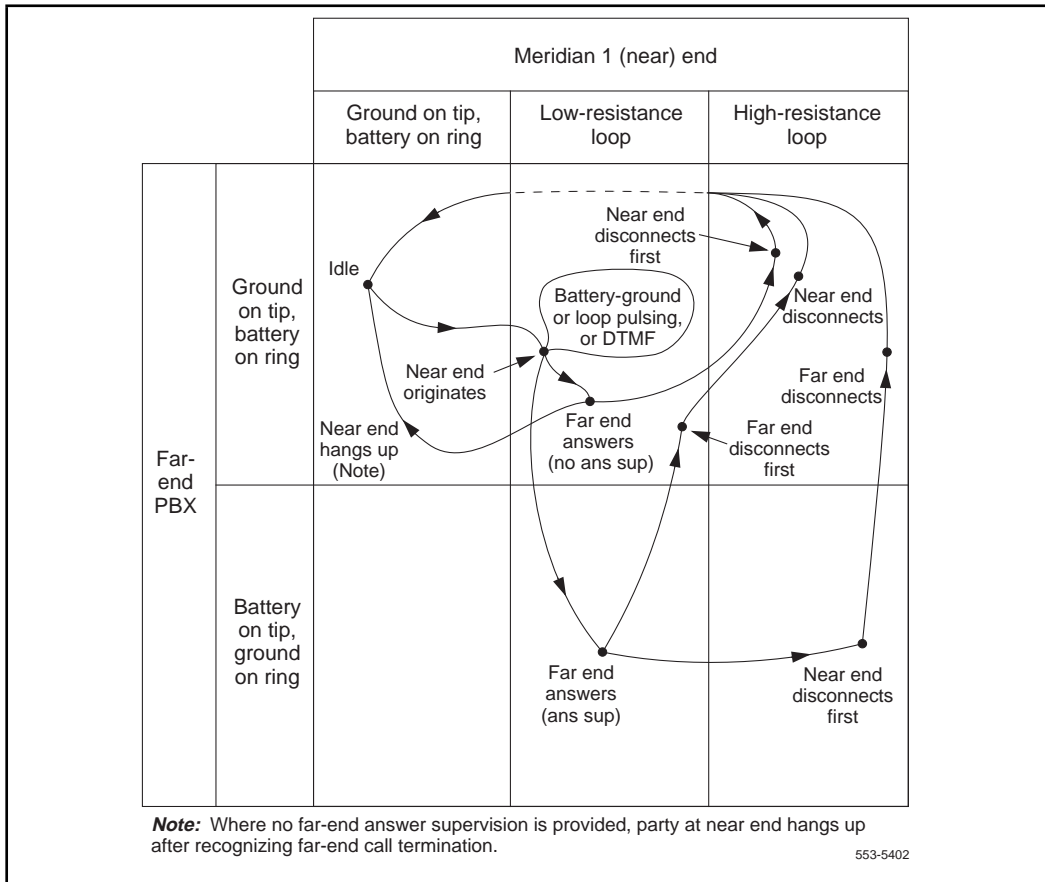




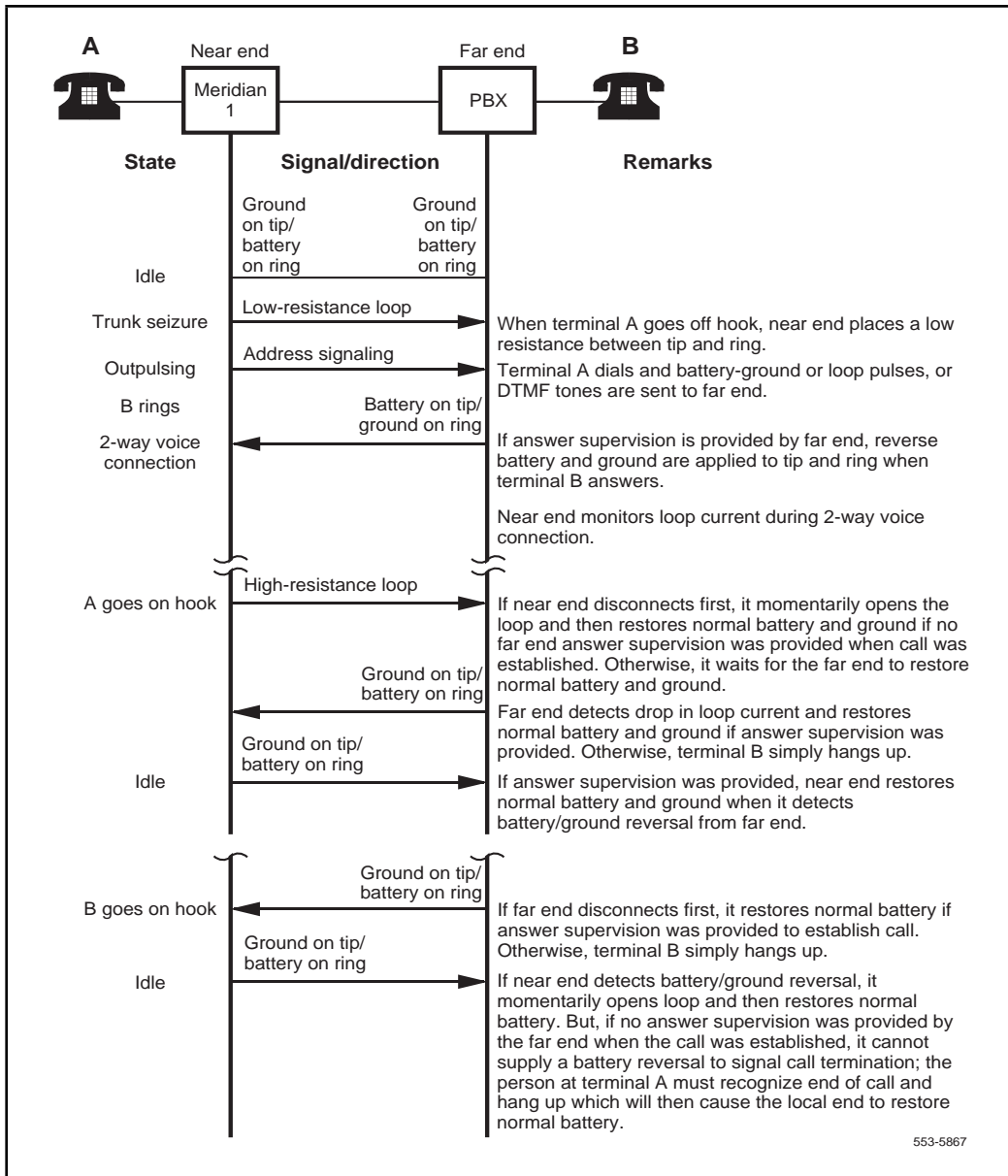
## Outgoing calls

In an outgoing call configuration, the DXUT card is connected to another PBX by a TIE trunk (see Figures 44 and 45). An outgoing call from the near end seizes the trunk facility by placing a low-resistance loop across the tip and ring leads. Outward addressing is then applied from the Meridian 1 in the form of DTMF tones or dial pulses. If answer supervision is provided by the far end, reverse battery and ground on tip and ring is returned. The operation represented in Figures 44 and 45 also applies to outgoing calls on a DID trunk.

**Figure 44**  
**Two-way, Loop DR, TIE trunk call states – outgoing call to far-end PBX**



**Figure 45**  
**Two-way, Loop DR, TIE trunk call connection sequence – outgoing call to far-end PBX**



553-5867

## Senderized operation for DID and two-way loop DR trunks

### Incoming calls

If the far end is senderized, the near end may be operated in any mode: immediate start (IMM), delay dial (DDL) or wink (WNK) start, as assigned at the Start arrangement Incoming (STRI) prompt in the Trunk Administration program (Overlay 14) (see Figure 46).

For immediate start, following the seizure signal, the far end may start pulsing after the standard delay (normally 65 ms, minimum).

For delay dial or wink start modes, stop/go signaling, (off-hook/on-hook or battery/ground reversal) is returned by the Meridian 1 after receipt of the seizure signal. The delay dial (stop) signal begins immediately upon seizure and ends (go signal) 384 ms later. The wink start (stop) signal begins 384 ms after seizure and ends (go signal) 256 ms later. The far end detecting the go signal may start pulsing after the standard delay (normally 55 ms, minimum). Stop/go signaling, in addition to the signaling function, serves as an integrity check to help identify a malfunctioning trunk.

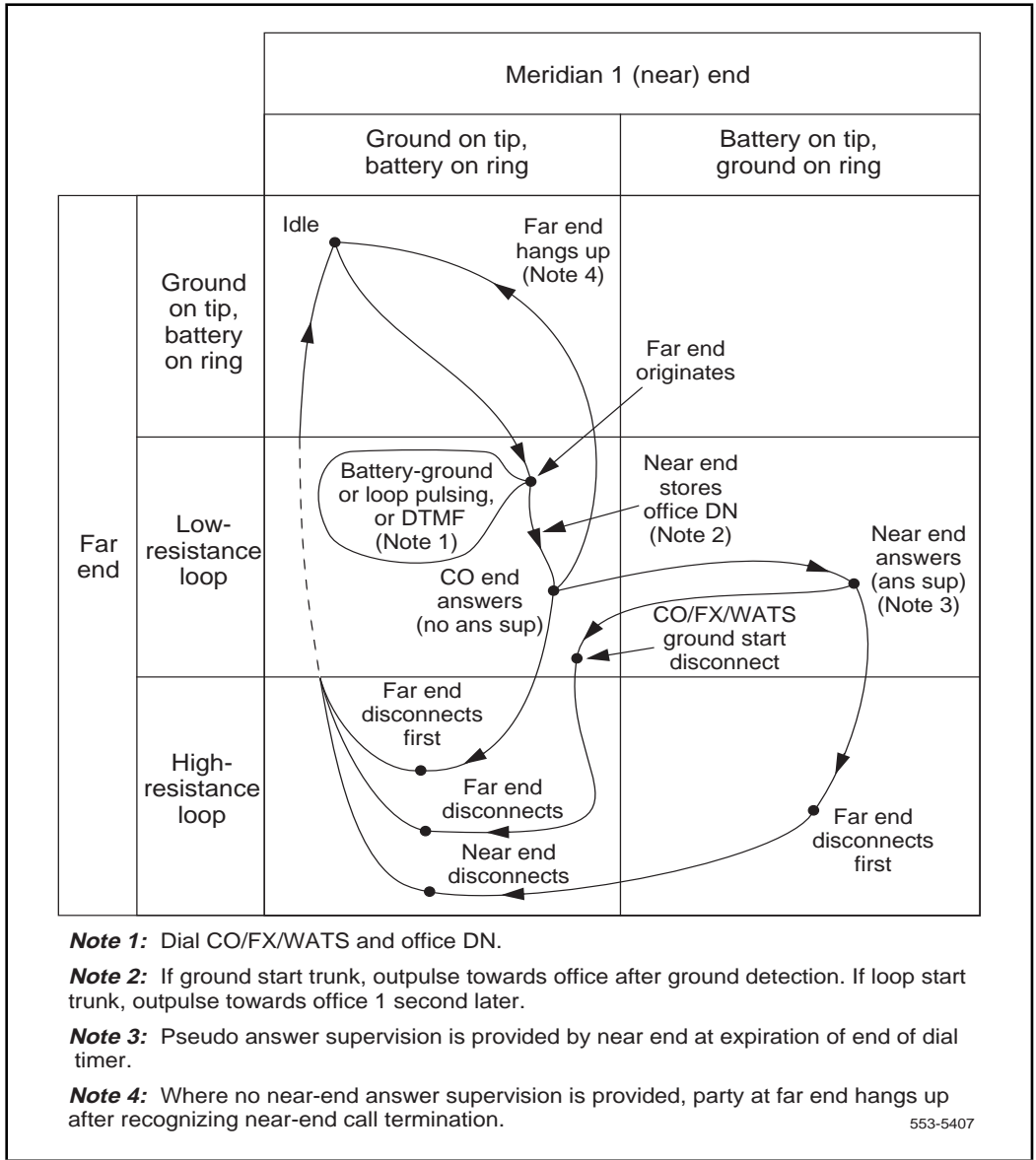
If required, the near end can be configured to provide pseudo answer supervision at expiration of the end of dial timer. End of dial timer settings are made at the EOD (non-DTMF) or ODT (DTMF) prompts in the Trunk Route Administration program (Overlay 16).

The operation represented in Figure 46 also applies to incoming calls on a DID trunk from a CO.

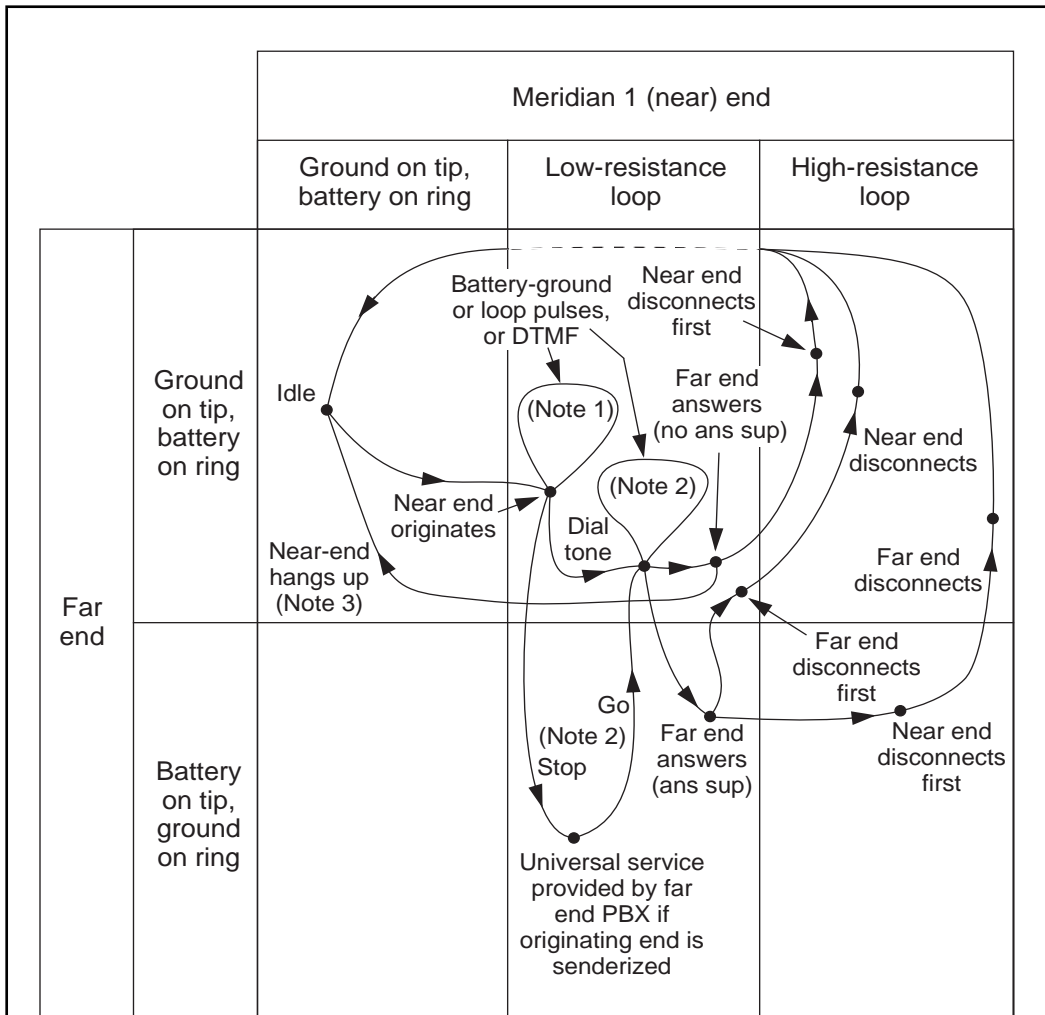
### Outgoing calls

When DDL or WNK mode is used, outgoing calls require a stop/go signal from the far end so that the near end cannot outpulse until the far end is ready to receive digits (see Figure 47).

**Figure 46**  
**Two-way, Loop DR, TIE trunk call states – incoming call through senderized, tandem PBX from a CO/FEX/WATS trunk**



**Figure 47**  
**Two-way, Loop DR, TIE trunk call states – outgoing call through far-end PBX to CO/FEX/WATS**



**Note 1:** Immediate-start outpulsing.

**Note 2:** Delay-dial or wink-start outpulsing after go signal.

**Note 3:** Where no far-end answer supervision is provided, party at near end hangs up after recognizing far-end call termination.

553-5411

## **Outgoing automatic, incoming dial operation**

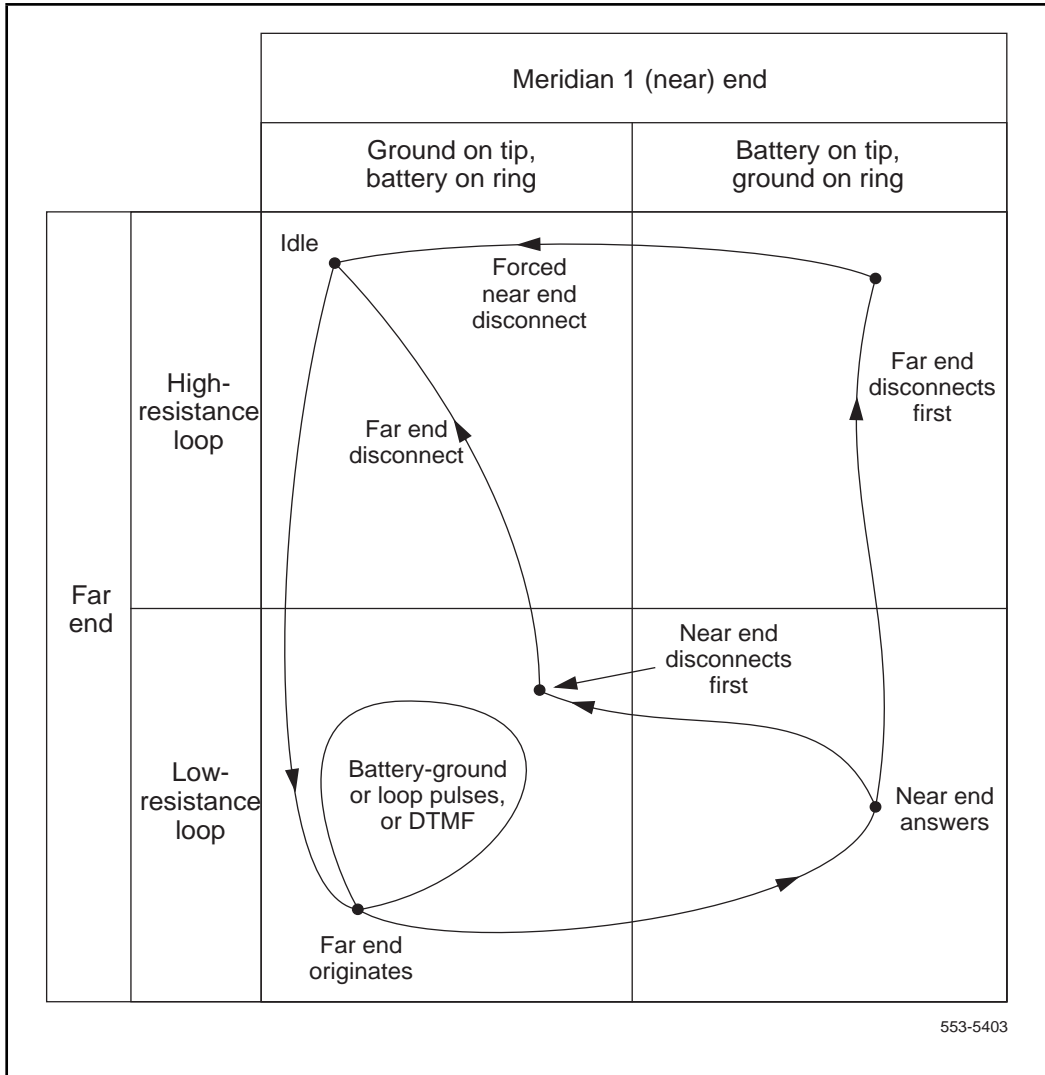
### **Incoming calls**

When the DXUT card is seized by the far end on an incoming call, a low-resistance loop is placed across the tip and ring leads. Addressing is then sent by the far end in the form of battery-ground or loop pulses, or DTMF tones. The trunk is released at the far end when the loop is opened. When the near end detects an open loop, it returns to a normal state. See Figures 48 and 49.

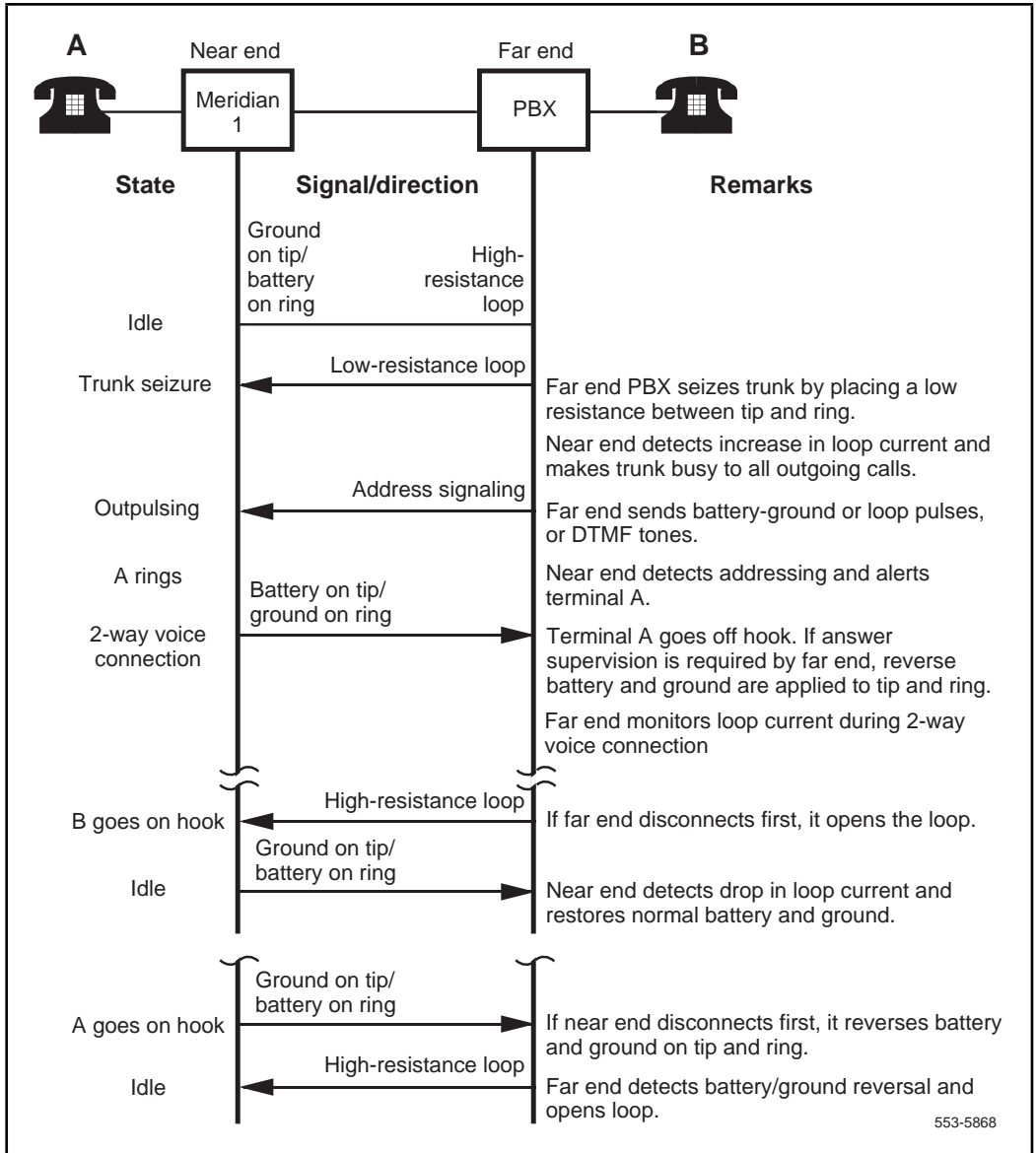
### **Outgoing calls**

When seized as a dial-selected outgoing trunk, the near end places battery on the tip and ground on the ring. This alerts the far end of the seizure. The far end responds with a low resistance across the tip and ring leads. See Figures 50 and 51.

**Figure 48**  
**Two-way, loop OAID, TIE trunk call states – incoming call from far-end PBX**



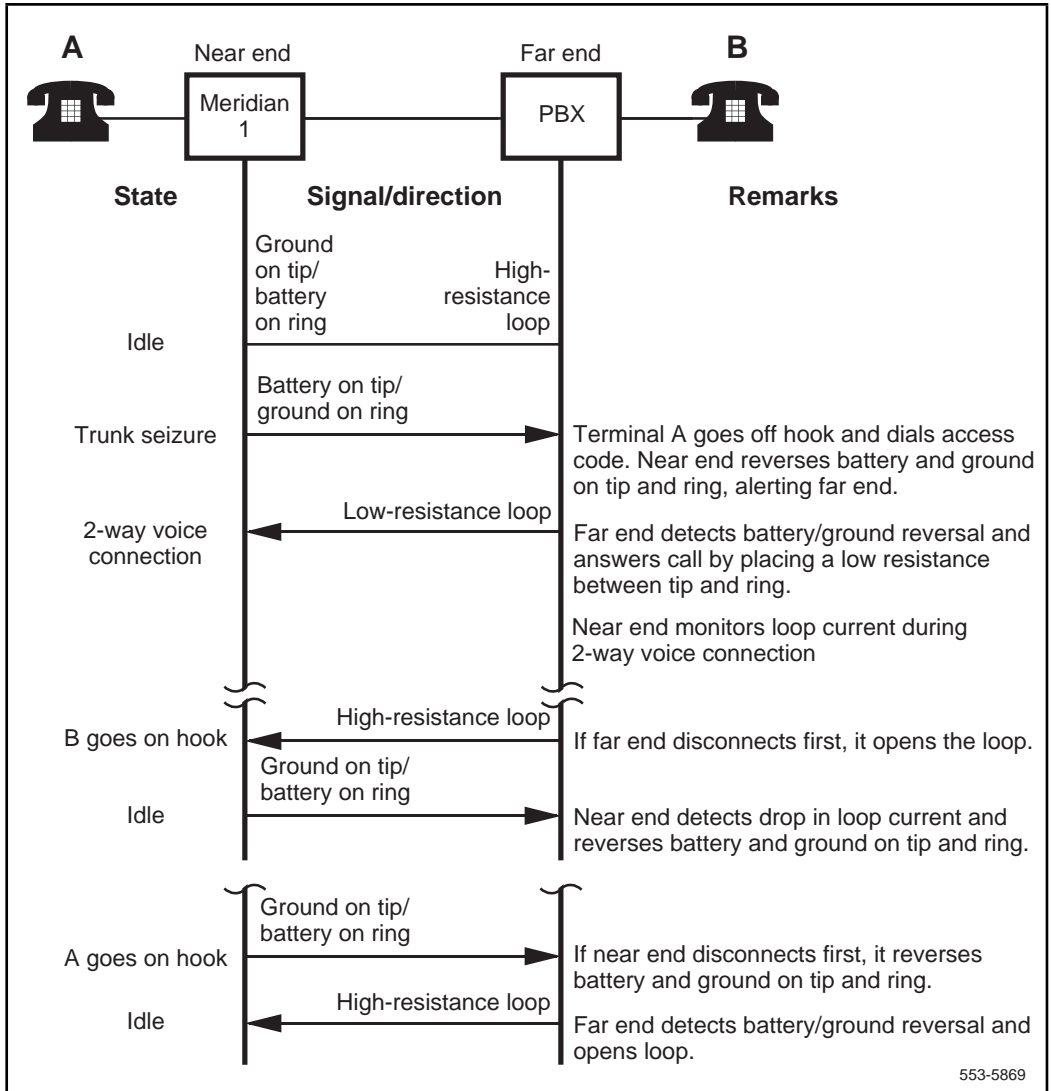
**Figure 49**  
**Two-way, loop OAID, TIE trunk call connection sequence – incoming call from far-end PBX**







**Figure 51**  
**Two-way, loop OAID, TIE trunk call connection sequence – outgoing call to far-end PBX**



## Recorded announcement trunk operation

When configured for Recorded Announcement (RAN) operation, a trunk unit is connected to a customer provided Recorded Announcement machine.

Announcement machines must be compatible with Meridian 1 RAN trunks and should be set up according to the manufacturer's instructions. Table 25 lists announcement machines that are available from Nortel.

**Table 25**  
**Northern Telecom Digital Announcers**

NT model no.	No. of chan	Voice sampling rate	Trunk connections	Available options		
				Remote record	Message times	Firmware
NT7M00	1	32 kHz or 22 kHz (switch selectable)	Hard-wired	Yes, with beep prompts	32 sec (std), 1, 1-1/2, 2, 3, 4, 5, 6, 7, 8 min	Basic single channel
NT5M02	2	32 kbps or 64 kbps (switch selectable)	RJ-21 connect- orized	Yes, with voice prompts	1 (std), 2, 3, 4, 5, 6, 7, 8 min	Basic multi-channel
NT5M04	4					Multi-chan/multi-user
NT5M06	6					Multi-chan demand phased
NT5M08	8					Multi-chan fixed length Split mem—demand phased
<p><b>Note:</b> The 2, 4, and 6 channel models of the NT5M can be upgraded to 8 channels in a single chassis.</p> <p>Both the NT7M and the NT5M are programmable for the continuous operation, pulse start, and level start modes of operation.</p> <p>Adapters are available for hardwired (wire-wrap), RJ-11 modular, or RJ-21 jack interfaces.</p> <p>The audio output of both the NT7M and the NT5M are 4 ohms, nominal.</p>						

Each trunk unit provides the following for operation with RAN equipment:

- pulse start, level start, or continuous operation modes
- selectable termination of tip and ring leads into 600 or 900 ohms for interface with a low-impedance (2- or 4-ohm) source
- connection of up to 24 trunk units to a single announcement machine channel

## Recorded Announcement machines

Recorded Announcement machines store prerecorded voice messages which are played back to the trunk units to which they are connected. Most commercially available announcement machines store recordings digitally, although some drum and tape units are still in service.

An announcement machine may provide one or more channels and each channel may be prerecorded with a different message. Some announcement machines also provide a special information tone (SIT) capability. These tones are inserted at the beginning of intercept messages (such as “Your call cannot be completed as dialed. Please check the number and try again.”)

Figure 52 shows a typical connection from a single announcement machine channel to unit 0 on a DXUT card installed in slot 0 in an NT8D37 IPE Module. See *Meridian 1 system installation procedures* for complete trunk wiring information.

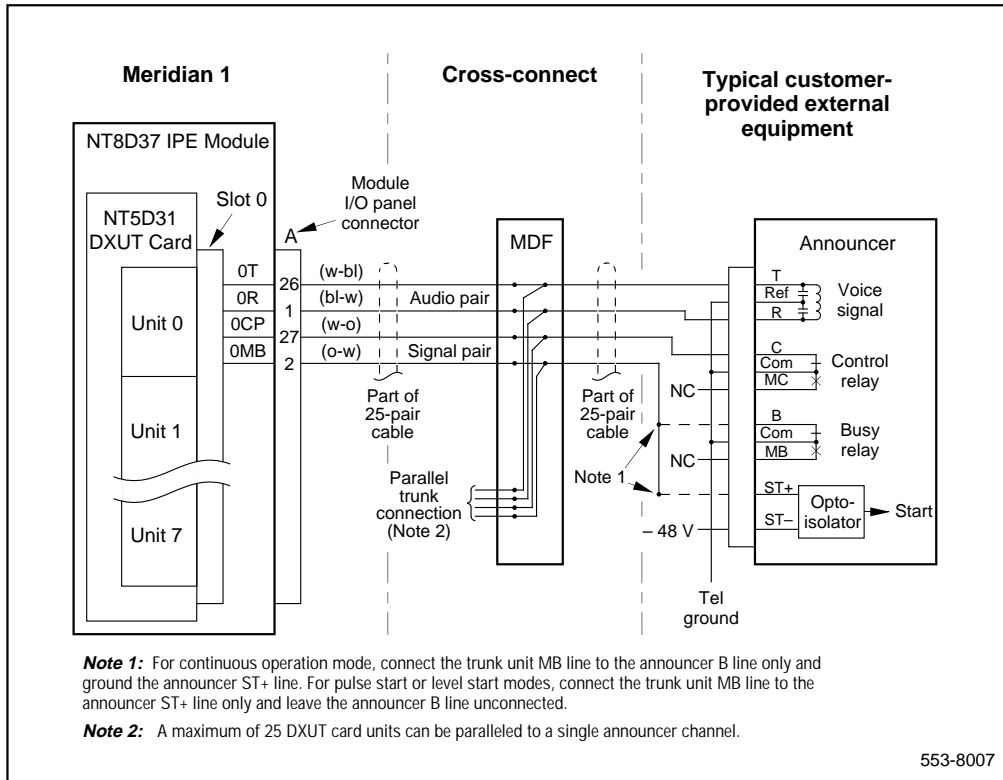
## RAN modes of operation

Figure 53 shows the relationship of control signals to message playback for the operating modes available in announcement machines. The signal names shown in the figure are typical of Nortel digital announcement machines and are used here for comparison to other manufacturer’s equipment that might be used.

### Continuous operation mode

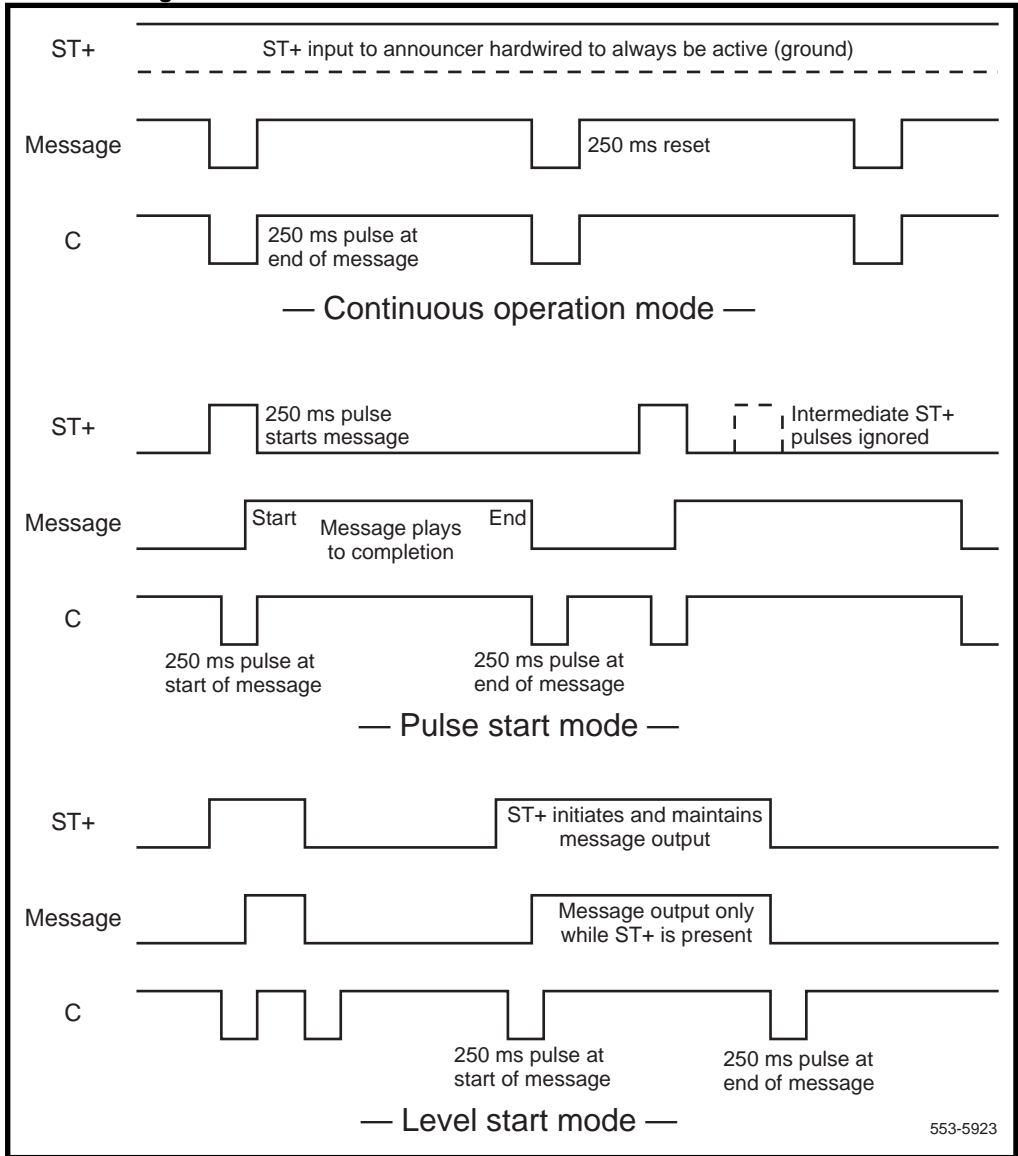
In the continuous operation mode (sometimes called the *audichron* mode), a message is constantly played, over and over again. Callers “barge in” on a playing message or are provided with a ringback tone until the message begins its next playing. The start line (ST+) is hardwired to always be active. See Figure 53. At the end of each message, a pulse is issued on the “C” line that is used by the trunk unit to cut through to the waiting call.

**Figure 52**  
**Connecting RAN equipment to the NT5D31AA (DXUT) card (typical)**



**Note:** The “B” (busy) signal line shown in Figure 52 (not represented in Figure 53) is used to indicate availability of an announcement machine message to the trunk unit when configured for the continuous operation mode. This signal is made active (ground) by the announcement machine if the channel contains a recorded message and is in an on-line condition. The “B” line is not connected to a trunk unit when configured for start mode operation.

**Figure 53**  
**RAN control signals**



### **Start modes (minimum vintage BA)**

In a start mode (sometimes called the *code-a-phone* or *start-stop* mode), playback of a message does not begin until a start pulse is received by the announcement machine. Two sub-categories of the start mode exist, pulse start and level start.

In the pulse start mode, a start pulse activates playback of a message that continues until completion. See Figure 53. The announcement machine ignores all other start pulses which might occur until the message is complete.

In the level start mode, the start signal is a “level” rather than a pulse. The leading edge of the start signal initiates message playback that continues until either the trailing edge of the start signal occurs or the end of the message is reached. A message that is terminated by the trailing edge of a level start signal is immediately reset and again made available for playback.

## **Call routing to RAN trunks**

Software programs in the Meridian 1 control Recorded Announcement machines. These programs detect the calls to be intercepted, determine the type of intercept treatment required (overflow, attendant, announcement, etc.), queue the intercept, and provide ringback tone to the calling party. At the proper time, an intercepted call is connected to the appropriate RAN trunk.

## **Programming RAN trunks**

The type of intercept and the RAN trunk parameters are defined in the Trunk Administration (Overlay 14), Customer Data Block (Overlay 15), and Trunk Route Administration (Overlay 16) programs.

The Trunk Administration and Route Administration programs specify the RAN trunk, the type of announcement machine, the number of repetitions of announcements before a forced disconnect (all calls) or an attendant intercept is initiated (CCSA/DID calls only), and the point at which the trunk may be connected to the announcement.

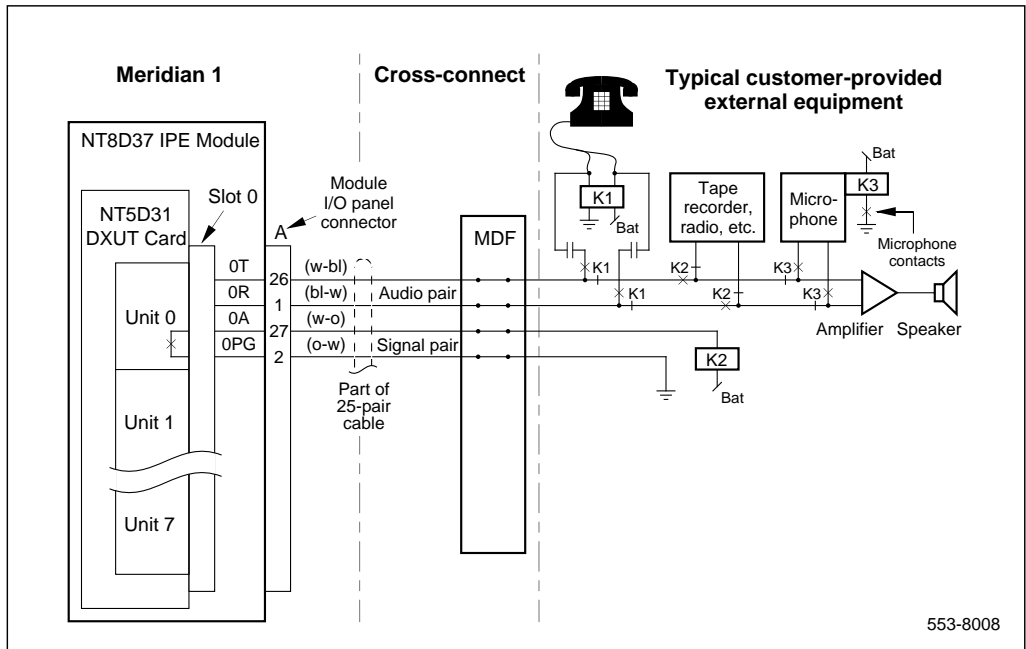
The Customer Data Block program defines the type of intercept and the trunk route to which the intercept is to be connected.

Refer to the *X11 input/output guide* for complete instructions on service change programs.

## Paging trunk operation

A DXUT card unit can be configured as a paging trunk. Configure units as Paging trunks in the Trunk Administration program (Overlay 14) and assign routes in the Route Administration program (Overlay 16). Figure 54 shows a typical connection from customer provided equipment to unit 0 on a DXUT card that is installed in slot 0 in an NT8D37 IPE Module. See *Meridian 1 system installation procedures* for complete trunk wiring information.

**Figure 54**  
**Connecting paging equipment to the NT5D31AA (DXUT) card (typical)**





## Music operation

A trunk unit can be connected to a music source. The audio source should provide an adjustable power output at 600 ohms. Configure units for music at the MUS or AWR prompts in the Trunk Administration program (Overlay 14) and assign routes at the MRT prompt in the Trunk Route Administration program (Overlay 16).

Music operation is similar to that of RAN in the continuous operation mode. Connect the unit tip and ring leads to the audio source and ground the CP line at the MDF. See Figure 52. If the music source is equipped with contacts that close when music is on line, use these contacts to provide a ground to the MB line; otherwise, ground the MB line at the MDF.

---

# Busy Tone Detection for Asia Pacific and CALA

---

The Busy Tone Detection feature for Asia Pacific and CALA uses the Digital Signaling Processor Universal Trunk (DXUT) card. This card is based on the Extended Universal Trunk card (EXUT) and allows for the following two capabilities:

- Flexible Busy Tone Detection
- Automatic Balance Impedance (AUTO\_BIMP in Overlay 14)

The Flexible Busy Tone Detection functionality of this trunk card allows the Meridian 1 to recognize busy tones sent from a Public Exchange/Central Office. Busy Tone Detection permits disconnect supervision for Loop Start Central Office (CO) trunks. The Central Office provides busy tone to the last party involved in a call. The Meridian 1 detects this busy tone and disconnects the call.

Busy Tone Detection features are utilized in countries where tone detection is the only method for the Meridian 1 to detect far end disconnection.

The Busy Tone Detection feature for Asia Pacific and CALA uses the X11 Release 23 NT5D31 Digital Signaling Processor (DSP) Universal Trunk (DXUT) card. This card is based on the Extended Universal Trunk card (EXUT) and is configured in the software as an EXUT card. However, the DXUT card has flexible busy tone detection provided by a digital signal processor (DSP). The DXUT card also has tone detection intelligence that allows it to accurately differentiate between different disconnect tones sent by a Public Exchange/Central Office.

The DXUT card has programmable Busy Tone Detection characteristics which include

- Cadence (same as Release 21 and 22)
- Incoming or Incoming and Outgoing call direction
- Tone Frequencies
- Tone Bandwidth
- Tone Levels

Tones are detected according to the parameters configured in Overlay 97.

When a trunk card does not support the Busy Tone Detection feature, it can still be configured in software; although, the hardware does not recognize the new Busy Tone messages. The DXUT messages are ignored by the old hardware. The existing hardware is still operational since the Busy Tone feature still supports the older hardware. Old messages are sent for backwards compatibility but are not resent to define frequency criteria.

The Automatic Balance Impedance (AUTO\_BIMP) functionalities of the DXUT card enhance the Transhybrid Loss matching capability. The automatic balancing is performed by the Digital Signal Processor (DSP) when checking the reflections from the transmission line. When the software sends an AUTO\_BIMP message to the DXUT card, the DSP generates a test tone and measures the amount of signal being reflected. The DSP then internally adjusts the balance network, in the codec, for the best Transhybrid loss.

## Operating parameters

The Busy Tone Detection feature for Asia Pacific and CALA requires the DXUT card. The DXUT card requires busy tone detection data to be downloaded prior to activating this feature.

The AUTO\_BIMP functionalities of this feature are supported in X11 Release 23 but not in the Digital Signaling Processor Universal Trunk (DXUT) card NT5D31 hardware.

Direct Inward Dialing (DID) trunks do not require busy tone supervision, since the Public Exchange/Central Office seizes the Meridian 1 trunk by closing the transmission loop. Far end trunk release is accomplished when the Public Exchange/Central Office opens the circuit.

Japan trunk cards, the Extended Universal Trunk card for Japan (XUTJ) and the Enhanced Extended Universal Trunk card for Japan (EXUTJ), do not support this feature. The DXUT card is not supported in Japan.

The Meridian 1 disconnects a call when a busy tone is detected on an incoming trunk. If the caller on the far end causes a busy tone to be generated, the call is disconnected, regardless of whether or not disconnection was intended. As an example, when a caller connected to a Public Exchange/Central Office attempts to conference in a busy party, the Meridian 1 picks up this busy tone and the call is disconnected.

If any other types of tones (other than busy tone) are detected with the same cadence, frequency and level, the call is disconnected.

The Busy Tone Detection feature for Asia Pacific and CALA may not operate on conference bridges. In the scenario of Busy Tone Detection operating with a conference bridge, all of the trunks are incoming and an incoming Public Exchange/Central Office trunk disconnects from a conference. In this scenario, the disconnected trunk sends a busy tone signal to the conference bridge, and all trunks may be disconnected simultaneously.

In the event that an incoming call is connected to an external conference and two different Public Exchanges/Central Offices are sending busy tone signals at the same time, a stalemate condition may exist. When this occurs, the cadence of both busy tones may not be the same, and the resulted combination cadences may not be detected.

The DXUT card is based on the EXUT card design and is intended to operate in an EXUT compatible Loss Planning environment. In X11 Release 22, these EXUT compatible Loss Planning environments included the North American Loss Planning environment and Dynamic Loss Switching environments in certain countries.

Busy Tone characteristics are downloaded on a card basis. The Busy Tone Detection table assigned to the card is downloaded to the card when: the first trunk is configured, the card is disabled and enabled, the card is unplugged and reset, during initialization after sysload, and when the Extended Peripheral Equipment is enabled.

## Feature interactions

### European XFCOT Support

When the XFCOT Busy Tone ID (BTID) is configured in Overlay 14 only the BTID is downloaded to the XFCOT card. The BTID is downloaded to the EXUT card when the Busy Tone Detection (BTD) package 294 is equipped.

### Trunk to Trunk Connection

When the Trunk to Trunk Connection feature interacts with Busy Tone Detection for Asia Pacific and CALA, whichever feature occurs first takes precedence.

### Timed Forced Disconnect

When Timed Forced Disconnect interacts with Busy Tone Detection for Asia Pacific and CALA, whichever feature occurs first takes precedence.

## Feature packaging

Busy Tone Detection for Asia Pacific and CALA requires Busy Tone Detection (BTD) package 294.

## Feature implementation

LD 97 – Configure Busy Tone Detection (BTD) table parameters.

*Note:* Once the BTD table is configured, the new trunks can be entered and the required BTD table is assigned on a card basis. The BTD table number can only be entered in for the first unit programmed on the card.

Prompt	Response	Description
REQ	CHG	Change existing data.
TYPE	BTD	Busy Tone Detection.
BTDT	(0) - 7	Busy Tone Detection Table.

BCAD	(350) (350)  500 500	<p>Busy Tone Cadence (in milliseconds). (ON cycle) (OFF cycle) (default)</p> <p>For Japan. The values for each cycle are 0 to 1.5 seconds (1500 ms) and are entered in milliseconds. Input values are rounded to the nearest multiple of 25 ms. If zero (0) is entered for both phases, then a continuous tone occurs.</p>
BTDD	(BOTH) INC	<p>Busy Tone Detection Direction: Both Incoming and outgoing calls (default). Incoming calls only.</p>
FREQ_0	350 - 655	<p>Frequency of Busy Tone for Frequency 0 of a dual Busy Tone Detection to be detected in Hz. Valid entries are in multiples of 5Hz.</p>
FREQ_1	350 - 655	<p>Frequency of Busy Tone for Frequency 1 of a dual Busy Tone Detection to be detected in Hz. Valid entries are in multiples of 5Hz.</p> <p>For a single busy tone FREQ_1 must be set the same as FREQ_0.</p>
FDLT	10 - 315	<p>Frequency Delta. FDLT gives the tolerance of the tone to be detected in +/- hertz. Valid entries are in multiples of 5Hz.</p> <p>For dual Busy Tone Detection on the NT5D31 card, the same maximum and minimum levels apply to both tones.</p>
FLVL_MAX	0 - 15	<p>Maximum Frequency Tone level to be detected. Valid entries are in multiples of 5dBm.</p> <p>For dual Busy Tone Detection on the NT5D31 card, the same level applies to both tones.</p>
FLVL_MIN	20 - 35	<p>Minimum Frequency Tone level to be detected. Valid entries are in multiples of 5dBm.</p> <p>For dual Busy Tone Detection on the NT5D31 card, the same level applies to both tones.</p>

LD 16 – Configure trunk units and trunk timers in the Route Data Block.

Prompt	Response	Description
REQ	NEW	Add a new data block to the system.
TYPE	RDB	Define a new Route Data Block.
CUST	xx	Enter customer number.
ROUT	0–511 0-127	Enter route number. For Option 11C.
TKTP	COT	Define trunk type as Central Office.
ICOG	IAO	Incoming and Outgoing trunk.
CNTL	YES	Changes to controls or timers.
NEDC	ETH	Either end control.
FEDC	ETH	Either end control.

LD 14 – Configure Busy Tone Supervision for a new Central Office Trunk.

Prompt	Response	Description
REQ	NEW	Add new data.
TYPE	COT	Central Office trunk.
TN	l s c u c u	Terminal Number. For Option 11C.
XTRK	EXUT	Type is IPE EXUT. This includes the DXUT. (This prompt is required only for the first unit defined on each card.)
CUST	xx	Customer number.
RTMB	0-511 1-254 0-127 1-254	Route number and Member number. For Option 11C.
SIGL	LOP	Loop start level 3 signaling.
TIMP	(600) 900	Termination Impedance.

BIMP	(3COM) 3CM2 600 900	Balance Impedance. In the case of AUTO_BIMP, this BIMP value is used as a default value if an optimum AUTO_BIMP is not found or if the AUTO_BIMP test is not complete.
AUTO_BIMP	YES	Automatic Balance Impedance is set according to transmission line parameters. NO = default for new trunks.  <b>Note:</b> <i>The Auto_BIMP prompt is supported in X11 Release 23 software but is not supported by the DXUT card NT5D31.</i>
SUPN	YES	Answer and disconnect supervision required.
-STYP	PIP BTS PIP BTS	Supervision Type. Polarity Insensitive Pack. Busy Tone Supervision. Both options.
BTDI	(0)-7	Busy Tone Detection Table number configured in LD 97. (This prompt is required only for the first unit defined on each card.)
CLS	(DIP) DTN	Dial Pulse. Digitone.

## Feature operation

No specific operating procedures are required to use this feature.





## Copyright Statement

© 1998 Northern Telecom

All rights reserved

Information is subject to change without notice.

Northern Telecom reserves the right to make changes in design or components as progress in engineering and manufacturing may warrant. This equipment has been tested and found to comply with the limits for a Class A digital device pursuant to Part 15 of the FCC rules, and the radio interference regulations of Industry Canada. These limits are designed to provide reasonable protection against harmful interference when the equipment is operated in a commercial environment. This equipment generates, uses and can radiate radio frequency energy, and if not installed and used in accordance with the instruction manual, may cause harmful interference to radio communications. Operation of this equipment in a residential area is likely to cause harmful interference in which case the user will be required to correct the interference at their own expense.

SL-1 and Meridian 1 are trademarks of Northern Telecom.

**NORTEL**

NORTHERN TELECOM