

---

Meridian 1 and Succession Communication Server for Enterprise 1000

# Meridian Integrated RAN

## Description, Installation, and Operation

---

Document Number: 553-3001-112  
Document Release: Standard 5.00  
Date: May 2002

---

Copyright © 1997–2002 Nortel Networks  
All Rights Reserved

Printed in Canada

Information is subject to change without notice. Nortel Networks reserves the right to make changes in design or components as progress in engineering and manufacturing may warrant. This equipment has been tested and found to comply with the limits for a Class A digital device pursuant to Part 15 of the FCC rules, and the radio interference regulations of Industry Canada. These limits are designed to provide reasonable protection against harmful interference when the equipment is operated in a commercial environment. This equipment generates, uses and can radiate radio frequency energy, and if not installed and used in accordance with the instruction manual, may cause harmful interference to radio communications. Operation of this equipment in a residential area is likely to cause harmful interference in which case the user will be required to correct the interference at their own expense.

SL-1, Meridian 1, and Succession are trademarks of Nortel Networks.

---



## Revision history

---

**May 2002**

Standard 5.00. Up-issued to include content for MIRAN III. This document applies to Meridian 1 and Succession CSE 1000 systems.

**January 2002**

Standard 4.00. Up-issued to support MIRAN 1 Release 25.4.

**April 2000**

Standard 3.00. This is a global document and is up-issued for X11 Release 25.0x.

**July 1999**

Standard, release 2.00. This release describes the second release of the Meridian Integrated RAN product, MIRAN Release 2.0.

**April 1997**

Standard, release 1.00. Initial release.



---

# Contents

---

<b>About this document</b> .....	<b>13</b>
Who should use this document .....	13
Organization of this document .....	13
What's New for this issue .....	15
<b>Description</b> .....	<b>17</b>
Contents .....	17
Introduction .....	18
Succession Media Card overview .....	18
Succession Media Card design characteristics .....	23
Succession Media Card channel overview .....	24
User interfaces overview .....	25
Browser User Interface .....	25
Text-based User Interface .....	26
Telephone User Interface .....	26
User interface multiple-access restrictions .....	28
Features overview .....	28
Calendar assignment feature .....	28
System time and date synchronization .....	33
Music-On-Hold option .....	33
RAN password security .....	34
Succession Media Card technical overview .....	36
Hardware architecture .....	36
Faceplate connectors and indicators .....	38
MIRAN III 50-pin I/O Adaptor (Audio-adaptor) .....	40

CE-MUX Interface .....	41
Succession Media Card reset and self-test functions .....	41
Software security .....	43
<b>Installation and configuration .....</b>	<b>47</b>
Contents .....	47
Reference list .....	48
Succession Media Card with MIRAN application quick installation procedure .....	48
System configuration .....	53
Configuring RAN routes .....	54
Music-On-Hold activation and route configuration .....	58
Configuring the DID route for the TUI .....	60
Configuring the MIRAN trunks .....	61
Configuring Ethernet for Time & Date Synchronization .....	62
Limited access password .....	62
Basic MIRAN III installation .....	62
Installation overview .....	62
Installing a MIRAN III Succession Media Card .....	63
Installation preparation .....	63
Succession Media Card installation in an IPE shelf .....	64
Succession Media Card installation in the Option 11C, 11C Mini, and Succession CSE 1000 .....	68
Connecting an external audio device .....	72
LAN access installation and setup .....	73
FTP downloads and uploads .....	75
Performing upgrades and replacements .....	78
PC Card Backups .....	78
Restoring configuration .....	79
RAN upgrades .....	79
Recording announcements remotely for use on the MIRAN III Succession Media Card .....	81
Foreign language prompt .....	83

<b>Engineering guidelines</b> .....	<b>85</b>
Contents .....	85
Reference list .....	85
Introduction .....	86
Software requirements .....	86
For users with Release 23 and Succession CSE 1000	
Release 1 or later, and RAN Broadcast .....	86
For users with Release 22.08 or 21.41 and earlier .....	88
For users with Release 21.45 or 22.16 and later,	
but without RAN Broadcast .....	89
MIRAN III requirements .....	89
MIRAN III Succession Media Card channel capacity options ....	90
MIRAN III Succession Media Card listener capacity options ....	90
Supported RAN modes .....	91
Voice storage capacity .....	92
Power and ground requirements .....	92
External equipment requirements .....	93
Maintenance terminal requirements .....	94
Telephone for OA&M access .....	94
External analog sources .....	95
Succession Media Card hardware list .....	95
Ethernet/LAN requirements .....	96
Summary of LAN installation information .....	99
Testing LAN configuration .....	99
Engineering MIRAN III Succession Media Card and	
music application .....	101
<b>RAN Application:</b>	
<b>Browser User Interface</b> .....	<b>107</b>
Contents .....	107
Introduction .....	108
Accessing the BUI .....	109
Logging in to the BUI .....	109
Navigating the BUI .....	111

MIRAN III Administration menu .....	111
Pack (MIRAN III Succession Media Card) Administration menu ..	123
Pack (MIRAN III Succession Media Card) Information .....	134
File System .....	137
Pack (MIRAN III Succession Media Card) User .....	143
Support .....	147
Resetting the BUI .....	151
Logging out of the BUI .....	151
Help on the BUI .....	151
<b>RAN Application:</b>	
<b>Text-based User Interface .....</b>	<b>153</b>
Contents .....	153
Introduction .....	154
General procedure for configuring MIRAN .....	155
Configuring the VT-100 type terminal .....	157
Login screen .....	158
Status screen .....	159
Main menu .....	161
MIRAN Administration menu .....	162
The Announcement Configuration menu .....	163
Convert Announcement File screen .....	183
Operational Statistics screen .....	185
Backup Configuration screen .....	186
Restore Configuration screen .....	188
Run Batch File screen .....	189
Pack Administration menu .....	190
File Commands menu .....	191
Keycode Entry screen .....	199
Software Upgrade screen .....	200
System Information screen .....	202
Configuration Variables menu .....	203
Ethernet Configuration screen .....	206
Time & Date Configuration menu .....	208



Maintenance and Diagnostics .....	213
User Administration menu .....	214
Add/Edit User screen .....	215
View Users screen .....	216
Delete User screen .....	217
MIRAN III Succession Media Card OA&M command set .....	218
OA&M Command summary .....	219
OA&M Commands .....	223
Announcement Commands .....	225
Calendar commands .....	226
Descriptor commands .....	228
User commands .....	229
File Commands .....	230
Miscellaneous Commands .....	233
MIRAN III batch file support .....	235
Setting up emergency announcements quickly .....	236

**RAN Application:  
Telephone User Interface ..... 239**

Contents .....	239
Introduction .....	239
Description .....	240
Restrictions on TUI access .....	241
Using the TUI .....	241
Login .....	241
Navigating the Main menu .....	242
Recording an announcement .....	243
Assigning an announcement .....	243
Retrieving channel information .....	245
Example of using the TUI .....	246
Voice prompts .....	247
TUI flowcharts .....	250

<b>Maintenance</b> .....	<b>259</b>
Contents .....	259
Reference list .....	259
Introduction .....	259
Maintenance overview .....	260
Diagnostic tools .....	260
LED indicators .....	261
Display codes .....	261
Overlay commands .....	261
MIRAN fault isolation and correction .....	262
MIRAN III fault isolation using the menu system .....	265
Card replacement .....	266
<b>Appendix A: Sound recording, codes, and interfaces</b> .....	<b>269</b>
Contents .....	269
Introduction .....	269
Sound recording configuration .....	269
Succession Media Card hexadecimal codes .....	271
MIRAN III Succession Media Card interface connectors .....	272
Maintenance Serial Port .....	272
Analog port and pinouts .....	275
I/O panel to modem cable .....	276
Modem setup .....	276
<b>Appendix B: Environmental and electrical regulatory data</b> .....	<b>277</b>
Contents .....	277
Introduction .....	277
Environmental specifications .....	277
Electrical regulatory standards .....	279
Electro-Magnetic Compatibility (EMC) .....	280

**Appendix C: NT8D37 cable connections . . . . . 283**

    Contents . . . . . 283

    NT8D37 cable connections . . . . . 283

        Tools list . . . . . 285

    NT8D81BA cable removal procedure . . . . . 286

    NT8D81BA cable installation procedure . . . . . 286

**List of terms . . . . . 287**

**Index . . . . . 295**



## About this document

---

This document applies to Meridian 1 Internet Enabled Options 11C, 11C Mini, 51C, 61C, 81C, and Succession Communication Server for Enterprise 1000 (Succession CSE 1000) systems.

This document is a global document. Contact your system supplier or your Nortel Networks representative to verify that the hardware and software described are supported in your area.

The *Meridian 1 Integrated RAN: Description, Installation, and Operation* (553-3001-112) provides information about the implementation of the Meridian Integrated Recorded Announcement (MIRAN) in the Meridian 1 and Succession CSE 1000 systems. It describes MIRAN operation and applications, as well as how to install, configure, administrate, and maintain MIRAN.

## Who should use this document

This document is intended for individuals responsible for installing, configuring, operating, and maintaining MIRAN.

## Organization of this document

This document contains the following chapters:

- **“Description” on page 17** describes MIRAN functional and Succession Media Card physical characteristics.
- **“Engineering guidelines” on page 85** describes system hardware and software requirements and MIRAN configuration options.

- **“Installation and configuration” on page 47** describes how to prepare the Meridian 1 and Succession CSE 1000 equipment, how to install the MIRAN III Succession Media Card in the Intelligent Peripheral Equipment (IPE) module or shelf, and how to connect the MIRAN III Succession Media Card to the external voice sources and voice delivery devices.

This section also describes the MIRAN configuration, RAN implementation, MIRAN expansion, channel assignment administration, and access security administration.

- **“RAN Application: Browser User Interface” on page 107** describes how to operate and administer the MIRAN III Succession Media Card using a web-based server hooked up to the LAN.
- **“RAN Application: Text-based User Interface” on page 153** describes different RAN applications based using the terminal OA&M access using menus and commands.
- **“RAN Application: Telephone User Interface” on page 239** describes how to use a DTMF telephone to record new announcements and how to place existing announcements in- or out-of-service.
- **“Maintenance” on page 259** describes how to maintain and troubleshoot the Succession Media Card and associated equipment.
- **Appendix A: “Sound recording, codes, and interfaces” on page 269** lists the MIRAN III Succession Media Card display hexadecimal codes, as well as pin assignment and connector types for external connections to the Succession Media Card. It also contains an example of how to configure the system for telephone set-based administration.
- **Appendix B: “Environmental and electrical regulatory data” on page 277** describes reliability, environmental specifications, product integrity, and regulatory standards for the Succession Media Card.
- **“NT8D37 cable connections” on page 283** contains information on NT8D37 cable connections.

## What's New for this issue

This document is updated to include content for MIRAN III. The application MIRAN III supports the MIRAN II functionality on the Succession Media Card platform.

*Note:* MIRAN II does not support the MIRAN III Succession Media Card platform. MIRAN III does not support the MIRAN II VPS platform.

MIRAN III introduces the following changes and enhancements to the MIRAN functionality:

- MIRAN III delivered on the Succession Media Card platform.
- The Succession Media Card has increased storage capacity. The storage space on the C: drive of the Succession Media Card increases to approximately 12 Mb (approximately 20 to 24 minutes of recording time) on a basic Succession Media Card.
- MIRAN III supports an enhanced Nortel Networks standard Browser User Interface (BUI).
- MIRAN III does not support Virtual LAN (V-LAN) connections.
- MIRAN III does not support multi cross-connect ports.

*Note:* In this document, the term Meridian 1 includes Option 11C, 11C Mini, 51C, 61C and 81C.





---

# Description

---

## Contents

This section contains information on the following topics:

Succession Media Card overview . . . . .	18
Succession Media Card design characteristics. . . . .	23
Succession Media Card channel overview. . . . .	24
MIRAN III capacity options. . . . .	24
User interfaces overview. . . . .	25
Browser User Interface. . . . .	25
Text-based User Interface. . . . .	26
Telephone User Interface. . . . .	26
User interface multiple-access restrictions. . . . .	28
Features overview. . . . .	28
Calendar assignment feature. . . . .	28
System time and date synchronization. . . . .	33
Music-On-Hold option. . . . .	33
RAN password security. . . . .	34
Succession Media Card technical overview. . . . .	36
Hardware architecture. . . . .	36
Faceplate connectors and indicators. . . . .	38
MIRAN III 50-pin I/O Adaptor (Audio-adaptor). . . . .	40
CE-MUX Interface. . . . .	41
Succession Media Card reset and self-test functions. . . . .	41
Software security. . . . .	43

## Introduction

This chapter describes the Meridian Integrated RAN, both at a system and card level. It describes the MIRAN III application functions, specifications, applications, and operation.

## Succession Media Card overview

MIRAN provides multi-tasking, voice-processing applications, such as Recorded Announcement (RAN) and Music-On-Hold (MOH). The MIRAN application is pre-installed on the NT0966 Succession Media Card. This single-slot card is compatible with Meridian 1, Option 11C, Option 11 Mini, and Succession CSE 1000 systems.

The NT0966 Succession Media Card communicates with the Meridian 1 system software and the Succession CSE 1000 software through trunk signaling messages over the DS-30X link. The Succession Media Card emulates the Enhanced Extended Universal Trunk (EXUT) card. The same overlay programs used to configure the EXUT card, trunk routes, and trunk functions are also used to configure the MIRAN routes.

A MIRAN III 50-pin I/O Adaptor (Audio-adaptor) connection provides analog access to MIRAN, in order to connect external recording equipment (for example, music from an external CD connection).

The Succession Media Card supports three MIRAN configurations: small, medium, and large. These cards offer two, four, and eight RAN ports respectively. The RAN Broadcast feature allows the multiplexing of the RAN ports.

**Note:** In North America, only the cards offering four and eight RAN ports are available. Refer to Table 1 on page 24.

MIRAN supports PC Cards. These cards:

- Expand MIRAN announcement storage memory.
- Back up announcements from MIRAN to the PC Card.

MIRAN II provided six minutes of internal announcement storage capacity in a basic MIRAN configuration while the MIRAN III provides 20 to 24 minutes. If 20 to 24 minutes of announcement storage capacity is sufficient, a Flash memory card is not required to expand the storage capacity.

The Succession Media Card connects to a maintenance terminal for Text-based OA&M over an RS-232 port.

The Succession Media Card can also connect to the maintenance terminal through telnet over a 10BaseT LAN connection to perform text-based OA&M. The Succession Media Card's internal web server can also be used to perform a web-based OA&M.

*Note:* A LAN connection is necessary for telnet access, web-based OA&M, and downloading files using FTP.

MIRAN also supports a Telephone User Interface (TUI). Use a DTMF telephone to do the following:

- Record new announcements.
- Swap existing announcements in and out of service.

To use the TUI, configure port 7 as a DID port dedicated to telephone access.

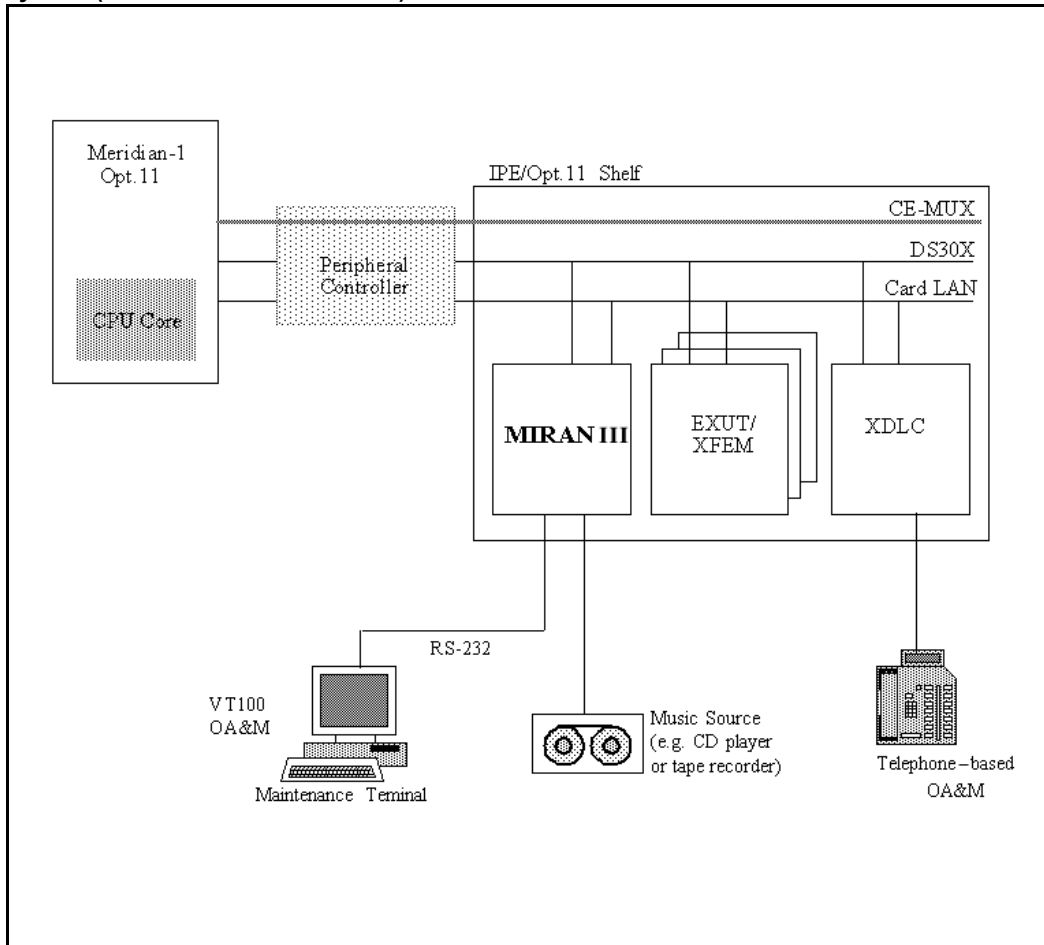
The Succession Media Card connects to an external music source over an analog I/O port on the MIRAN III 50-pin I/O Adaptor (Audio-adaptor). This port can also be used to input music from a music source (for example, a tape recorder or a CD player).

Figure 1 on page 20 illustrates the connection of a maintenance terminal to the Succession Media Card. The connection of an external music source is also shown.

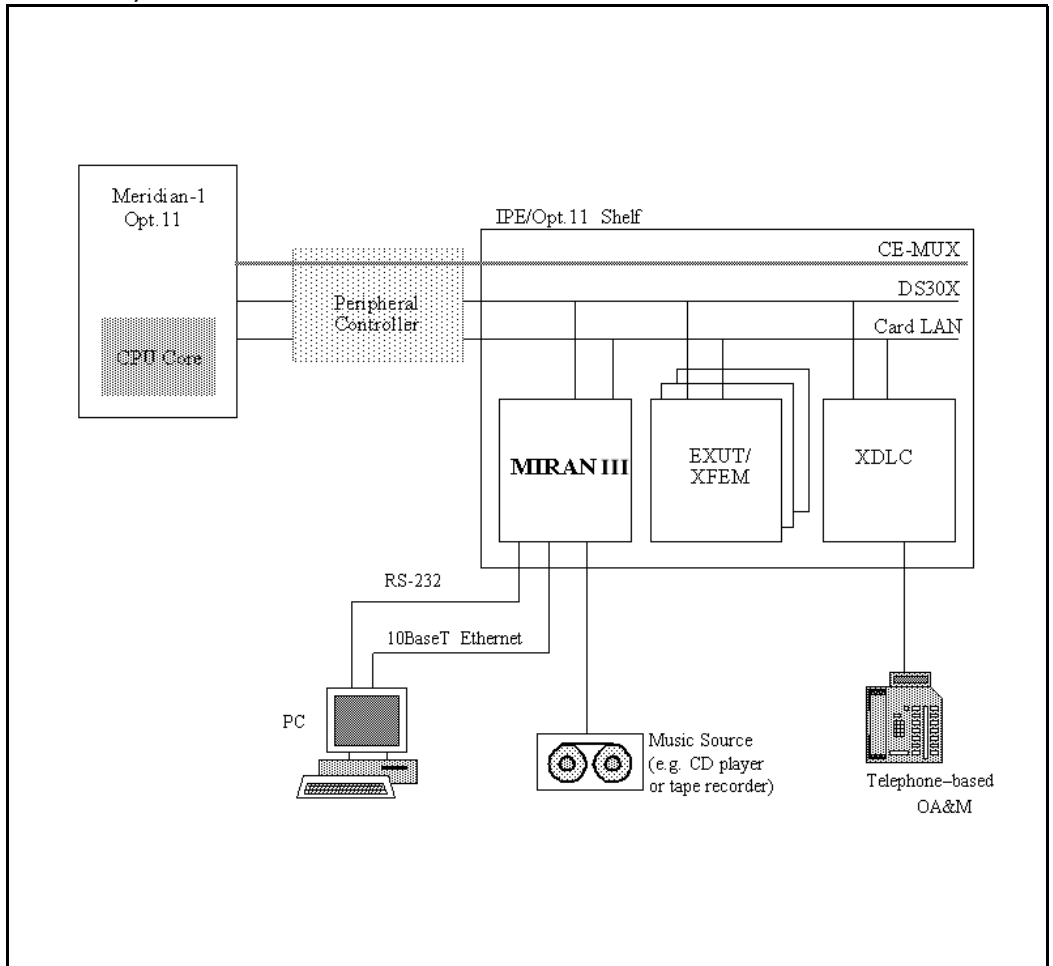
Figure 2 on page 21 illustrates the connection of a 10BaseT Ethernet connection to the Succession Media Card. The connection of an external music source is also shown.

Figure 3 on page 22 illustrates the connection of a modem to the Succession Media Card.

**Figure 1**  
**Succession Media Card interface structure in the Meridian 1 and Succession CSE 1000 system (without a LAN connection)**

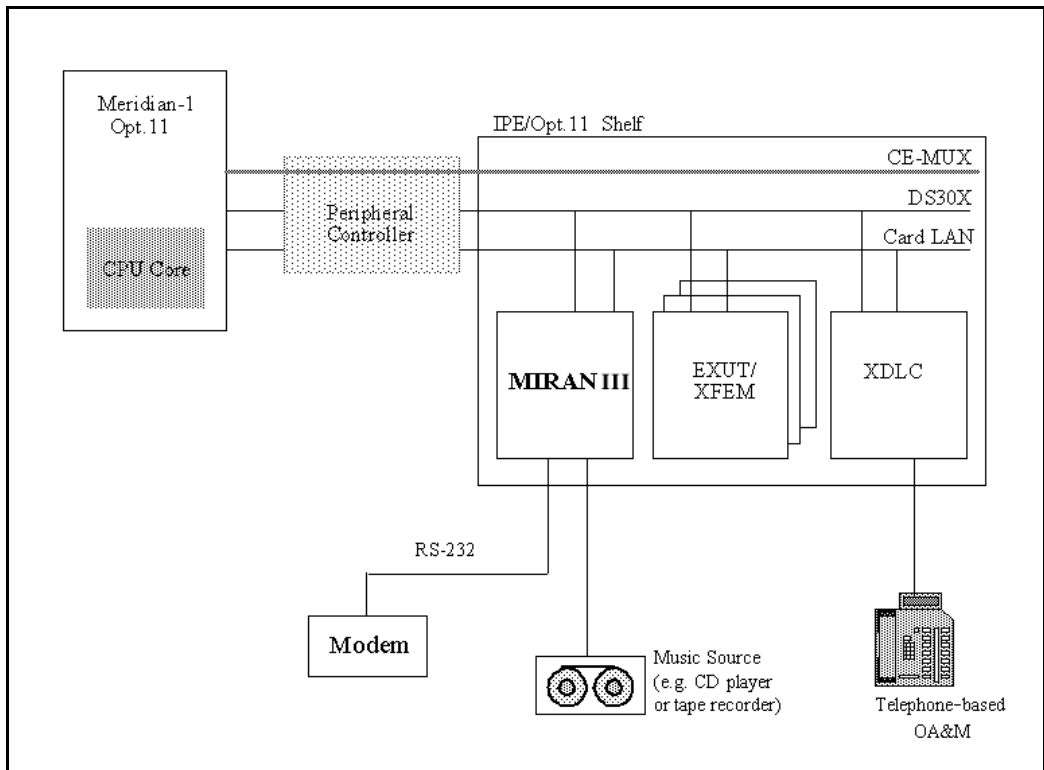


**Figure 2**  
**Succession Media Card interface structure in the Meridian 1 system (using a LAN connection)**



**Note:** For details on Installation and Configuration of LAN connectivity, refer to “LAN access installation and setup” on page 73 and “Ethernet/LAN requirements” on page 96.

**Figure 3**  
**Succession Media Card connected to modem**



The Succession Media Card provides the following flexibility:

- easily expandable, industry-standard architecture (small, medium, and large configuration, controlled by keycode)
- a set of both standard and proprietary interfaces
- compatibility with all systems that support IPE cards
- embedded real-time operating system
- simplicity to RAN and MOH applications (no external devices or cables)
- versatile storage capacity features provide for:

- a recording storage capacity of 20 to 24 minutes on the base MIRAN III configuration
- unlimited different announcements for each channel, per day, changeable on a time-of-day and day-of-year basis
- an option to add extra storage space with a PC Card (approximately two minutes of recording time for each Mbyte of extended memory)
- a maximum eight internal one-to-one RAN or MOH ports/channels, which support continuous and start/stop RAN mode (up to seven ports/channels, if one is used for telephone-based OA&M access)
- a versatile set of recording features that include the following:
  - different announcements programmed to play at different times of day and different days of the year
  - FTP downloading of voice and music files through the LAN
  - swapping of “in-service” and “in-reserve” announcements using a DTMF telephone
  - announcement backup and restore capability
  - transfer of existing announcements to the Succession Media Card
  - new announcements recorded over a telephone or from common plug-in audio equipment (for example, CD players and cassette players)
  - password-protected RAN recording from any DTMF telephone using a simple voice menu interface
  - connection of one external analog (music) source for recording

### **Succession Media Card design characteristics**

The Succession Media Card supports voice processing by providing connectivity to the Meridian 1 and Succession CSE 1000 system, voice storage capacity, and access to an OA&M facility.

The Succession Media Card with the MIRAN III application:

- Is based on the Succession Media Card platform, which uses an Intel IXP-1200 Network Processor.
- Uses standard interface buses (PCI, ISA, and PCMCIA).

- Accesses all 32 DS-30X voice/signaling timeslots.
- Provides one RS-232 Maintenance Serial Port (through the faceplate 8-pin Mini-DIN connector and the MIRAN III 50-pin I/O Adaptor (Audio-adaptor).
- Supports connection to the LAN through an Ethernet adaptor.

### Succession Media Card channel overview

One-to-one recording ports/channel on the Succession Media Card emulates the Enhanced Extended Universal Trunk (EXUT) card.

*Note:* Each MIRAN III capacity option consists of the NT0966CA Succession Media Card, the NTDK57 Security Device, and a keycode.

Table 1 shows the MIRAN capacity options. For each capacity option in Table 1, the port 7 on the Succession Media Card can be configured for telephone-based OA&M.

**Table 1**  
**MIRAN III capacity options**

MIRAN III capacity option	No. of one-to-one ports/channels (North America)	No. of one-to-one ports/channels (International)
Small	Not applicable	2 (See Note 1)
Medium	4 (See Note 1)	4 (See Note 1)
Large	8	8
<i>Note 1:</i> Also includes port 7 for the Telephone User Interface (TUI)		
<i>Note 2:</i> MIRAN III does not support multi-cross connect ports.		



### **Supported applications**

MIRAN supports the following applications:

- First RAN
- Second RAN
- Intercept treatment
- Music-On-Hold
- Automatic Wake-up

## **User interfaces overview**

### **Browser User Interface**

MIRAN III incorporates a Nortel Networks standard Browser User Interface (BUI). The MIRAN III BUI is a web server embedded in the Succession Media Card. With the MIRAN BUI, users can access the Succession Media Card through the LAN, using a standard internet browser. All installation and administration can be performed through the browser. The BUI provides OA&M screens similar to the Text-based User Interface.

The BUI applies to Succession Media Cards configured with a valid IP address and connected to a LAN through an Ethernet adaptor. Alternatively, once the IP address has been configured, users can access the BUI by direct connection to the Succession Media Card, using a cross-over cable. For equipment and configuration information regarding the MIRAN BUI, refer to “LAN access installation and setup” on page 73.

*Note:* For the web browser, Nortel Networks recommends a minimum of Netscape Communicator 4.7 or Internet Explorer 4.0. Any web browser used must support HTML frames.

Refer to “RAN Application: Browser User Interface” on page 107 for more information on the BUI.

## Text-based User Interface

The Text-based User Interface provides menus and commands so that all necessary MIRAN OA&M functions can be performed. The software for this is part of the MIRAN-specific OA&M tool running under VxWorks™. VxWorks software is independent of Meridian 1 and Succession CSE 1000 software.

There are two ways to use the Text-based User Interface to access all commands and options:

- Use the menu system.
- Enter commands on the command line.

To use the MIRAN Text-based User Interface, access the Succession Media Card through a VT-100 type terminal. The Succession Media Card supports a serial connection between the terminal and the card.

The Succession Media Card also supports telnet access to the Text-based User Interface over a LAN. The serial interface takes precedence over the telnet interface. If a user has logged in through the serial interface, no one can log in through telnet. If someone has logged in through telnet, another user can remove the telnet user by logging in through the serial interface.

*Note:* Nortel Networks recommends HyperTerminal for PC-based telnet access.

Refer to “RAN Application: Text-based User Interface” on page 153 for more information on the Text-based User Interface.

## Telephone User Interface

A Telephone User Interface (TUI) within the MIRAN III application allows the application to be accessed from any telephone. The DTMF telephone can be either internal or external to the PBX system. The TUI uses a series of simple voice menus and prompts for quick modification of announcements and other simple tasks.

*Note:* Extensive changes must be handled through the Text-based User Interface or the Browser User Interface (BUI).

You can perform the following tasks through the TUI:

- Record new announcements.
- Play announcements.
- Assign and unassign announcements to MIRAN III ports.
- Access the Succession Media Card security ID.

You *cannot* perform the following tasks through the TUI:

- Set the Succession Media Card clock.
- Assign time-of-day restrictions to announcements.
- Access system configuration functions.
- Change passwords.

The TUI allows a user to login and issue specific commands using the dialpad of a Meridian Digital Telephone or any standard DTMF telephone. For security, the login requires a valid user name and password, which the administrator supplies. The Succession Media Card does not identify itself until a valid user name and password have been entered.

The TUI reduces the MIRAN III one-to-one ports available for RAN or music from eight to seven. Because there is no messaging between Succession Media Cards, port 7 must be reserved for the TUI on each Succession Media Card that requires this interface. If a Succession Media Card does not require the TUI, all eight ports on the card are available for RAN or music.

Refer to “RAN Application: Telephone User Interface” on page 239 for more information on the TUI.

## User interface multiple-access restrictions

Multiple users can simultaneously access a Succession Media Card. However, there are restrictions under which simultaneous access can occur. Table 2 shows the various situations in which multiple access can occur.

**Table 2**  
**User interface multiple-access restrictions**

A user has logged in through the...	Can more than one user log simultaneously in through the...			
	Text UI	TUI	BUI	FTP
Text-based User Interface (Text UI)	No	Yes	Yes	Yes
Telephone User Interface (TUI)	Yes	No	Yes	Yes
Browser User Interface (BUI)	Yes	Yes	Yes	Yes
File Transfer Protocol (FTP)	Yes	Yes	Yes	No

## Features overview

### Calendar assignment feature

MIRAN III software supports the Calendar assignments used in scheduling announcements. The assignments are made on a daily and monthly basis, regardless of year, using a 366-day calendar.

#### Calendar assignments

The Calendar assignment method of assigning files is more powerful and flexible than the “day, time, and filename” method which was employed in the original MIRAN product.

When a Calendar assignment is created, it is assigned a ‘weighting’ based on how specific the assignment is. Assignments are sorted in the Calendar list according to this weighting. The more specific assignments appear at the top of the list while the least specific assignments appear at the end. MIRAN searches the Calendar list when making channel assignments. The first entry in the list that matches the current day, time and channel will be the correct choice. If a match cannot be found in the Calendar list, the search reverts to the assignment lists.

All Calendar assignments consist of the following components:

- 1 Channel entry—can be a single channel (for example, 6); a range of channels (for example, 2-4); a combination (for example, 0, 2-4, 7); or a wildcard, \* (star symbol), to denote all channels.

**Note:** When a wildcard is used, it affects only the channels to which the current user has access. These are the channels that are assigned to the user's channel group.

- 2 Time entry—can be a single time (for example, 9:00); a range of times, (for example, 9:00-10:15); or a wildcard, \* (star symbol), to denote the entire day. A wildcard can also be entered instead of the minutes (for example, 9:\*) to indicate the entire hour. Table 3 provides examples of time entries. The entries are sorted in order of most specific to least specific and indicates the order in which the entries would appear in the Calendar list.

**Table 3**

**Time entry examples—sorted from most specific to least specific**

Time entry	Comment
9:00-9:30	Range of times (no wildcards allowed) <b>Note:</b> The range '10:00-16:30' is more specific than '10:*' due to the use of the wildcard.
9:*	Entire hour (9:00 to 9:59)
9:00	9:00 until the end of the day (9:00 to 23:59)
* (star symbol)	Entire day (0:00 to 23:59)

- 3 Date entry—can be a single date (for example, 20/2); a range of dates, (for example, 20/2-25/2); a single day (for example, MON); or a range of days (for example, MON-WED). A wildcard, \* (star symbol), can be used instead of the day or the month (for example, 25/\* would denote the 25th of each month, and \*/12 would denote every day in December). A wildcard used alone, \* (star symbol), denotes every day.

Table 4 provides examples of date entries. The entries are sorted in order of most specific to least specific and indicates the order in which the entries would appear in the Calendar list.

**Table 4**  
**Date entry examples—most specific to least specific**

Date Entry	Comment
20/1	Specific date
20/1-25/1	Range of dates (no wildcards allowed)
1/*	First day of every month
*/1	Every day in January
MON	Every Monday
MON-WED	Every Monday through Wednesday <b>Note:</b> THUR-MON is also a valid range
* (star symbol)	Every day of the year

**Note:** The time and date definitions can be combined as part of a “descriptor”. Refer to “Calendar descriptors” on page 31.

- 4 Filename or codec channel—specifies the file to play when the assignment is active, or the analog channel (displayed in the drop-down list as “Codec”).

## Calendar descriptors

The Calendar descriptors are a user-friendly way to store frequently used times and dates for Calendar assignments. Each date and time pair is assigned a descriptor name which denotes the period.

For example, to make assignments for the hour a business is closed for lunch, 13:00 to 14:00 Monday through Friday, instead of making the assignment manually, define a calendar descriptor called **'lunch'**. The descriptor **'lunch'** would have a date entry of **'MON-FRI'** and a time entry of either **'13:\*'**, or **'13:00-14:00'**. Assignments would then be made using the descriptor **'lunch'**. The **'lunch'** descriptor can be re-defined at any time, and it will take effect for all assignments using **'lunch'**. Use calendar descriptors to avoid manually changing each assignment. This eliminates the chance that an assignment might be missed.

Table 5 on page 32 shows sample Calendar Descriptors that could be used in making assignments. These descriptors are sorted from the most specific to the least specific and appear in the same order in which they would appear in the list of Calendar assignments.

*Note: **Jan\_sales\_closed** has the time defined as '\*' (star symbol). This means at all times; however, because of the way the entries are sorted, **jan\_sales\_open** is always found during times when the store is open. During the time the store is closed, the search will 'fall through' to the **jan\_sales\_closed** assignment.*

**Table 5**  
**Calendar Descriptor examples – most specific to least specific**

Descriptor name	Date	Time	Comment
christmas	25/12	*	Christmas Day
jan_sales_open	1/1-20/1	9:00-17:30	January Sales - Store Open
jan_sales_closed	1/1-20/1	*	January Sales - Store Closed
1st_of_month	1/*	*	First Day of Every Month
weekend	Sat-Sun	*	Weekends
weekday	Mon-Fri	*	Weekdays
morning	*	8:00-10:30	Every Morning
opening_time	*	9:00	Store Opening Time
closing_time	*	17:30	Store Closing Time
always	*	*	Always

**Calendar files**

The Calendar List is saved as a file called \_ASSIGNS.CAL. The Calendar Descriptors are saved in a file called \_DESCRIP.CAL. The Calendar Descriptors file is loaded before the Calendar file so that the descriptors used in the Calendar file can be validated.

*Note:* Multiple Calendar List files and Descriptor files can be created, where each file contains a group of calendar assignments or descriptors. These files can be swapped in and out, and transferred to other MIRAN III Succession Media Cards. Refer to “Calendar Operations menu” on page 165 and “The Descriptor Operations menu” on page 175.



## System time and date synchronization

The Succession Media Card can be configured to download the system time and date from the Meridian 1 or Succession CSE 1000 system on boot-up. The Succession Media Card remotely logs in to the system and starts a terminal session. Once the session has been established, the Succession Media Card accesses Overlay and extracts the system time and date by sending the TTAD command. The session is ended and the real-time clock is set accordingly. The IP address of the Meridian 1 is stored in `_CONFIG.DAT`. The use of this feature cancels the OA&M commands `SETDAY`, `SETTIME`, and `SETDATE`.

Refer to “Configuring Ethernet for Time & Date Synchronization” on page 62 and “Time & Date Configuration menu” on page 208 for instructions on configuring the system time and date synchronization.

*Note:* MIRAN III can either synchronize the time and date with the Meridian 1 or Succession CSE 1000 system, or have the time and date set manually.

## Music-On-Hold option

A card can have music routes and trunks programmed to provide Music-On-Hold service to callers. MIRAN provides approximately six minutes of pre-recorded, royalty-free music on the internal C: drive. This music is in Succession Media Card Compressed Format (MCF) and is pre-assigned to internal channel 0.

*Note:* The music assignment to internal channel 0 can be changed. Also, the royalty-free music file can be deleted if it is not needed.

The Music Broadcast feature allows a maximum of 64 callers to simultaneously listen to music on a single channel.

### External music

A permanent connection is maintained, over the analog input port, between an external music source, such as a CD player or tape recorder, and a MIRAN III Succession Media Card. This port is available on the MIRAN III 50-pin I/O Adaptor (Audio-adaptor). External music is most suitable when the music must be changed frequently.

The analog input is not confined to music. It can be used in many applications, such as a “talking timetable” or advertisements that are changed on a regular basis. It is often used on the larger systems where a piece of audio equipment is dedicated for this purpose.

*Note:* The Succession Media Card does not support 600 or 900 Ohm music sources.

### **Internal music**

Internal music can be used when a music source is not permanently connected to a Succession Media Card. A technician can use an external music source to record the music onto the MIRAN III Succession Media Card, where it is stored digitally in Flash memory.

## **RAN password security**

Access to the MIRAN III administration menus is password controlled using the following password levels:

- User
- Administrator
- Distributor
- Super User (Nortel Networks access)

These are the restrictions for accessing the MIRAN III:

- User – the lowest restrictions. Users can only access the User level.
- Administrator – the second highest level of restrictions. Users can access the user and administrator levels, and can change passwords for each of those levels.
- Distributor – the third highest of restrictions. Users can access user, administrator and distributor levels, and can change the passwords for those levels.
- Super User – is available for Nortel Networks employees. Users can access all levels, including debugging area, and can change passwords for all those levels.

### **User level**

The user password must be 8 to 16 alphanumeric characters in length. The user default password is “**user0000**”. The general OA&M password allows a user to login to the MIRAN III administration menu. This password level provides unrestricted access to all of the RAN-based, and most of the MIRAN III Succession Media Card level, administration options. The user password does not provide access to any diagnostic procedures.

*Note:* TUI access to the OA&M functions is at the User level.

### **Administrator level**

The administrator password must be 8 to 16 alphanumeric characters in length. The administrator default password is “**admin000**”. The Administrator level permits the following actions:

- creation of new users
- assignment of passwords
- channel access permissions
- deletion of existing users
- viewing/editing user information.

Individual users can alter their own password. The administrator can alter any user’s password and channel access permissions.

### **Distributor level**

The distributor level password must be 8 to 16 alphanumeric characters. The distributor default password is “**distrib0**”. The distributor level is the next level of access above the Administrator. The distributor is able to access the base code self-test and diagnostic procedures. This password level provides announcement monitoring for Card-LAN, DS-30X, and 8051 signals.

### **Super User level**

The Super User level allows remote access to the VxWorks shell, in order to perform maintenance and diagnosis of problems in the field.

*Note:* The Super User access level is for Nortel Networks employees.

## Succession Media Card technical overview

The MIRAN III Succession Media Card implements RAN and MOH applications for the Meridian 1 and Succession CSE 1000 and systems supporting IPE cards.

The Succession Media Card provides faceplate and backplane interfaces, which are used to connect external RAN and music sources and maintenance terminals to MIRAN III. This section provides information on the faceplate connectors and indicators, as well as the backplane connections to the MDF.

### Hardware architecture

The Succession Media Card is designed with the Intel IXP1200 Network Processor as its core. The microprocessor interfaces directly to the DRAM array and cache memory and to the rest of the system over PCI and SAI buses over the PCI bus and the buffered SRAM bus.

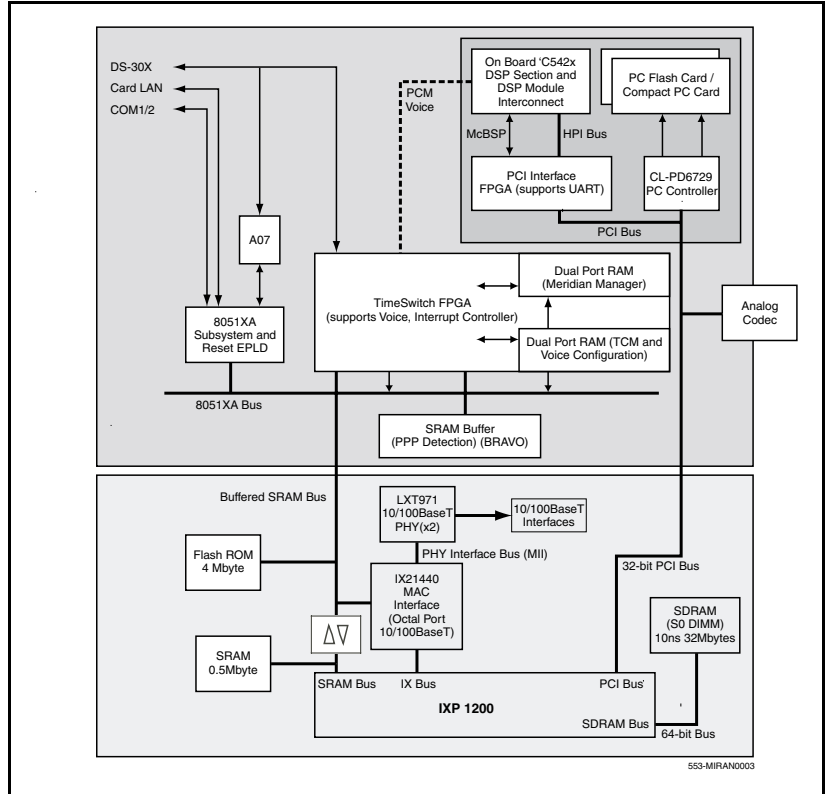
Meridian 1 and Succession CSE 1000 system interfaces, such as Card-LAN and DS-30X, connect to a dedicated microcontroller. This microcontroller communicates with the core microprocessor over the dual-port RAM.

To optimize the installation of the Succession Media Card with the MIRAN III application the following are provided:

- a faceplate connection for external device occasional use
- an I/O panel connection for MIRAN III 50-pin I/O Adaptor (Audio-adaptor) for external device permanent use

Figure 4 provides a high-level block diagram of the Succession Media Card components.

**Figure 4**  
**Succession Media Card components**



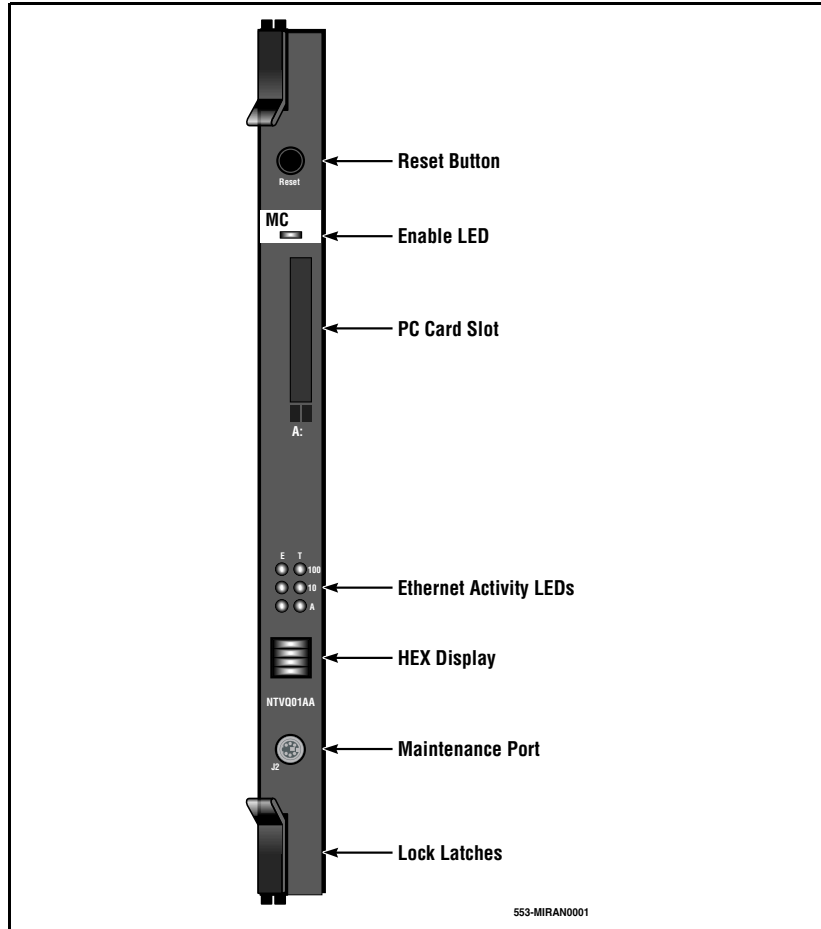
## Faceplate connectors and indicators

Figure 5 shows the NT0966CA (MIRAN application) Succession Media Card faceplate.

### Reset switch

Use the reset switch on the faceplate to manually reset the Succession Media Card.

**Figure 5**  
**NT0966CA Succession Media Card faceplate**



**Status LED**

The Succession Media Card faceplate red enable LED indicates the following:

- the enabled/disabled status of the card
- the self-testing result during power up or card insertion into an operational system

**PC Card slot**

This slot accepts standard PC Flash Cards, including ATA Flash cards (3 Mb to 170 Mb).

Nortel Networks supplies PC Card adaptors which allow compact flash cards to be used in this slot.

This slot is used for Succession Media Card software upgrades, backing up announcements, and additional storage.

**Ethernet activity LEDs**

The Succession Media Card faceplate contains Ethernet activity LEDs for each network.

**Hex display**

A four-digit, LED-based hexadecimal display provides the following information:

- **T:xx** - indicates the status of the internal self-test during boot-up. See Table 6 on page 271.
- **MRN3** - indicates that the MIRAN III application is running on the card.
- **WAIT** - indicates that it can take a number of seconds before the PC Card is ready for use after the insertion of a PC Card. During that time, the Hex display generates the message "WAIT". While the "WAIT" message is displayed, do not remove the PC Card. Once the card is ready for use the Hex display displays "MRN3". At this stage the user can remove the PC Card. Similarly, after removal of a PC Card, the "WAIT" message is displayed for about one second. The operator should not re-insert a PC Card until the "MRN3" message is displayed.

### RS-232 Asynchronous Maintenance Port

An 8-pin mini-DIN socket on the Succession Media Card faceplate provides access to the RS-232 port. This faceplate port can provide access to the MIRAN III for OA&M purposes. This port is also available through a female DB-9 connector on the MIRAN III 50-pin I/O Adaptor (Audio-adaptor). This should be used to make a permanent terminal connection.

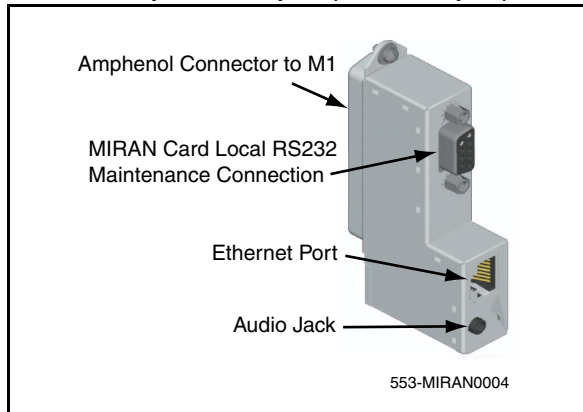
### MIRAN III 50-pin I/O Adaptor (Audio-adaptor)

The MIRAN III 50-pin I/O Adaptor (Audio-adaptor) mounts to the I/O panel on the IPE module. It contains the following:

- one RJ-45 connector for connection to the LAN
- one DB-9 female connector for connection to a maintenance terminal (either directly or through a modem)
- one 50-pin connector for connection to the I/O panel on the IPE module

Figure 6 on page 40 shows the MIRAN III 50-pin I/O Adaptor (Audio-adaptor).

**Figure 6**  
**MIRAN III 50-pin I/O Adaptor (Audio-adaptor)**



**Note:** It is important that the 50-pin connector of the MIRAN III 50-pin I/O Adaptor (Audio-adaptor) be secured to the I/O connector using the mounting screw provided on the top of the 50-pin connector, as well as the fastener on the bottom.



The Succession Media Card provides the following connections through the MIRAN III 50-pin I/O Adaptor (Audio-adaptor):

- Succession Media Card local RS-232 maintenance connection (9-way D-sub connector)
- 10BaseT Ethernet management connection
- audio socket for Music-On-Hold

### **Maintenance Serial Port**

A Maintenance Serial port is provided on the MIRAN III 50-pin I/O Adaptor (Audio-adaptor) for maintenance functions. A terminal can be permanently connected here. This port is duplicated on the faceplate.

### **Audio jack**

The 3.5 mm audio jack provides access to a single analog input (ANALOG0). Use the audio jack to connect external analog sources, such as a tape recorder or CD player to record to file or to route directly through a trunk emulation port into Meridian 1 and Succession CSE 1000 for MOH. Refer to Figure 6 on page 40.

### **Ethernet port**

The MIRAN III 50-pin I/O Adaptor (Audio-adaptor) provides one 10BaseT Ethernet management connection.

## **CE-MUX Interface**

The Succession Media Card does not support CE-MUX Interface.

## **Succession Media Card reset and self-test functions**

A reset is executed immediately following a power-on or system-level reset. This procedure initializes the processor before proceeding with the power-on self-test. The Succession Media Card attempts to log the source of each reset condition. This information can later be displayed on the maintenance terminal to find the cause of the problem, and the time and date when it occurred.

### **Hard reset**

A hard reset is equivalent to a card insertion or loss of power. It results in a total reset of all hardware elements and a full hardware and software initialization. A hard reset is always followed by a power-up sequence. This process can last up to two minutes.

A hard reset can be initiated by any of the following activities:

- card-level maintenance over the RS-232 port
- through a menu option in BUI
- by the administrator after upgrading MIRAN software

### **Diagnostic self-test**

This tests the installed hardware and does the following:

- Determines the integrity of the hardware.
- Establishes MIRAN III configuration in terms of its processor, RAM capacity, and Flash memory.

The Succession Media Card displays any unexpected results on the maintenance port and updates the Flash configuration. It can also indicate self-test results on the Succession Media Card faceplate hex display.

### **BIOS initialization**

This process initializes the base hardware, using configuration information stored in Flash. The BIOS layer provides initialization and device drivers.

The BIOS layer initializes the hardware and boots the operating system, using the low-level reset, self-test, and BIOS initialization.

## Software security

To provide security for the RAN and music applications as well as to prevent unlawful product usage, the Succession Media Card uses a security device and keycode security approach.

### Security overview

A security device and keycode mechanism is necessary to protect against unlawful MIRAN III feature usage, because industry-standard PC Cards are used as the software medium on the Succession Media Card. All upgrades of either channel capacity or application software are restricted to a given Succession Media Card and are accurately tracked to allow for satisfactory handling of field repairs and incremental upgrades.

Security is required for the following upgrades:

- port/channel capacity upgrades

Security is not required for the following upgrades:

- customer recorded prompts
- back up and restore operations
- application patching/bug fix

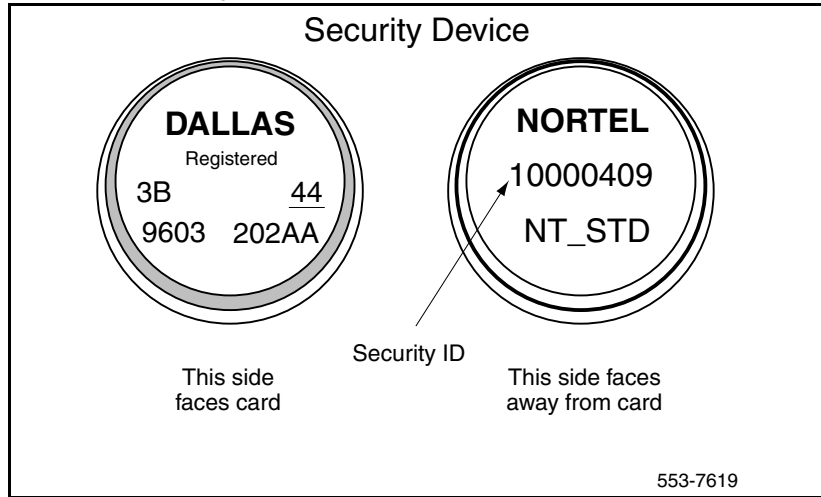
### Security device

This button-sized device has a unique 12-digit laser-etched code that cannot be overwritten. In addition, it contains 1 kbit/s of PROM to:

- identify the button as part of a Nortel Networks product
- provide an eight-digit security ID

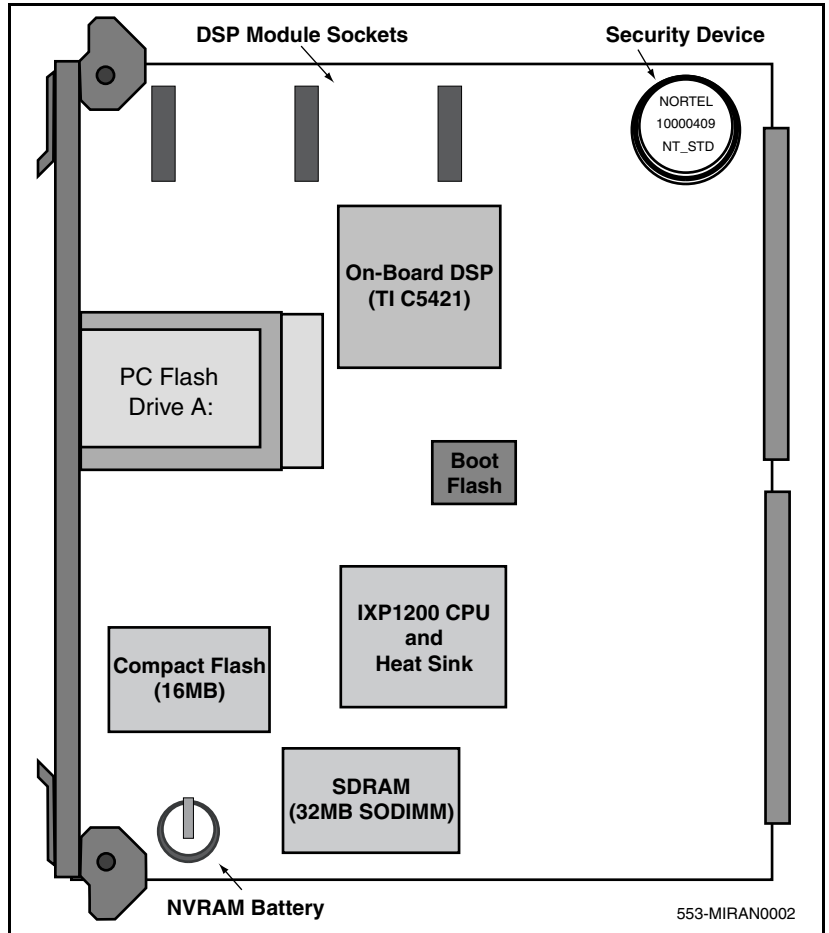
Figure 7 on page 44 illustrates an example of a security device that contains a unique 12-digit laser etched code and 1kbit of PROM pre-programmed with Nortel Networks specific information. The 'NORTEL'-side of the security device shows the eight-digit security ID. The security device must be installed with the eight-digit inscription facing away from the card.

**Figure 7**  
**Example of security devices**



**Note:** If the security device is properly installed, the Nortel Networks logo, with the eight-digit inscription underneath, is visible. Figure 8 on page 45 shows the position of the security device on the Succession Media Card.

**Figure 8**  
**Security device installation in the Succession Media Card**



### **Security ID**

The security ID is the number that the customer must query from the Succession Media Card maintenance port prior to ordering an upgrade. It is read from the security device and it is unique for each Succession Media Card.

The security ID number can be found:

- at the top left-hand corner of the terminal-based OA&M menu or screen
- by using a command on the telephone set-based OA&M access
- on an adhesive label in the box
- on the shipping paperwork
- on the BUI System Information screen
- etched on the security device

### **Keycode**

Nortel Networks provides the customer with a keycode that enables the customer to install any desired upgrade. The keycode is entered over a terminal using the local maintenance port on the Succession Media Card or using the BUI. The keycode consists of three sets of eight digits and must match the Security ID on the Succession Media Card.

The Succession Media Card comes from the factory equipped with a keycode. Upgrade keycodes can be purchased to enable more ports. Spare and repaired Succession Media Cards are not equipped with a keycode nor with the security device. For the Succession Media Card to operate correctly, the keycode must be installed.

---

# Installation and configuration

---

## Contents

This section contains information on the following topics:

Succession Media Card with MIRAN application quick installation procedure. . . . .	48
System configuration. . . . .	53
Configuring RAN routes. . . . .	54
Music-On-Hold activation and route configuration. . . . .	58
Configuring the DID route for the TUL. . . . .	60
Configuring the MIRAN trunks. . . . .	61
Configuring Ethernet for Time & Date Synchronization. . . . .	62
Basic MIRAN III installation. . . . .	62
Installation overview. . . . .	62
Installation preparation. . . . .	63
Succession Media Card installation in an IPE shelf. . . . .	64
Succession Media Card installation in the Option 11C, 11C Mini, and Succession CSE 1000. . . . .	68
Connecting a VT100-type terminal to the Succession Media Card. . . . .	69
Connecting an external audio device. . . . .	72
LAN access installation and setup. . . . .	73
Enabling the LAN capabilities. . . . .	73
Accessing the MIRAN III BUL. . . . .	75
Telneting to the Succession Media Card. . . . .	75
FTP downloads and uploads. . . . .	75
Performing upgrades and replacements. . . . .	78
PC Card Backups. . . . .	78
Restoring configuration. . . . .	79

RAN upgrades. ....	79
Recording announcements remotely for use on the MIRAN III Succession Media Card. . . . .	81

## Reference list

The following are the references in this section:

- *Features and services* (553-3001-306)
- *Administration Input/Output Guide* (553-3001-311)

## Succession Media Card with MIRAN application quick installation procedure

To quickly install and configure the MIRAN III product, follow the steps in Procedure 1.

### **Procedure 1** **Succession Media Card quick installation procedure**

- 1 Log in to the Meridian 1 system.
  - a. Program a DID route and configure a DID trunk on Succession Media Card unit 7.  
Use the TN for the loop, shelf, and card slot into which the Succession Media Card is plugged.  
For example, if the Succession Media Card was installed in 20 0 0, then provision 20 0 0 7 as the DID unit to allow local telephone access for the recording of RAN announcements.



- 2 Program RAN and Music routes and trunks for the remaining channels. For example, program channel 0 as a Music trunk and channel 1 as a RAN trunk.

**Note:** MIRAN comes with royalty-free music pre-assigned to channel 0 and set to play 'always'. Therefore, Nortel Networks recommends that channel 0 be configured as a Music route. However, this assignment can be removed and any other announcement or music file assigned in its place.

For pre-Release 23 Meridian 1 systems, see "Multi-channel level start/stop RAN route" on page 56 and "Level start/stop RAN route" on page 57.

If using Meridian Release 23 and Succession CSE 1000 X21 Release 1, refer to the RAN Broadcast feature in *Feature and Services* (553-3001-306). For MIRAN III with Release 23 or later, and configured with RAN Broadcast, use Route Type "MLVL" (RTYP = MLVL in Overlay 16).

- 3 Request an IP address, subnet mask, and gateway from the system administrator.  
**Note:** This step is only necessary if MIRAN III is connecting to the LAN.
- 4 Insert the security device onto the Succession Media Card. Install the security device with the Nortel Networks logo and eight-digit inscription facing away from the board.  
**Note:** The security device can be correctly inserted in only one position.
- 5 Connect the 50-pin female connector on the Succession Media Card Audio-adaptor to the I/O panel.
- 6 Connect the RJ-45 connector to the LAN hub. Use an RJ-45 coupler and the additional RJ-45 cable, if necessary.
- 7 Connect a VT-100 terminal to the MIRAN III 50-pin I/O Adaptor (Audio-adaptor) using a standard serial cable (NTAG81GA is available as an accessory from Nortel Networks).
- 8 Alternatively, the NTAG81CA cable (also available as an accessory) can be used to connect a terminal to the 8-pin faceplate connector.
- 9 Configure the terminal in VT-100 mode at 9600 baud, 8 data bits, 1 stop bit, and no parity.

- 10 Insert the Succession Media Card into an unequipped card slot and watch the terminal screen for boot-up commands to appear. This requires approximately 90 seconds.



**CAUTION**

**Damage to Equipment**

Before installing a Succession Media Card into a card slot, ensure that no cross-connect wires from Succession Media Card or another product remain attached to this slot. Cross-connect wires that carry a ringing voltage can damage the Succession Media Card.

- 11 At the logon screen of the Text-based User Interface, ensure that the cursor is in the 'User Name:' field. Then, log on by doing the following:
  - a. If the Media Card is being booted for the very first time, the cards will boot in BOOTP mode. If a BOOTP server is not being used, the card will continue to search for a BOOTP server on the network, thereby stalling the boot process.

At this point, users that are not using a BOOTP server should enter the key sequence +++ (plus symbols) in order to force booting to continue. Once booted, the user should change the IP method to either disabled or static (see Procedure 8 and Procedure 9). Once the IP method is changed to disabled or static, subsequent boots of the card do not look for a BOOTP server.

- b. If the Succession Media Card is booted and users are just starting the session or if an 'access denied' message is received, press the 'Shift' key and the tilde key (~) to refresh the screen.
  - c. Type in the user name (**admin**), and press the 'down' arrow.
  - d. Type in the administrator default password (**admin000**), and press the 'down' arrow again.
  - e. Press <CR> at the 'Login' prompt.

**Note:** If the logon is unsuccessful, an 'Access denied' message appears. The logon procedure can be repeated up to three times. If an 'Access denied' response appears for a third time, the Succession Media Card locks users out for 20 minutes.

- 12** At the Main menu:
- a.** Select **2**, “Pack Administration”.
  - b.** Select **2**, “Keycode Entry”.
- Note:** The keycodes are on a label that accompanies the security device. Remove this keycode label and attach it to the Succession Media Card faceplate.
- c.** Between the brackets, type in the 24-character keycode with a space between each set of eight characters.
  - d.** Select **Execute** to execute the keycode.  
Wait for a keycode validation response ‘Keycode validated’.
  - e.** Select **Exit** to return to the Pack Administration menu.
- Note:** If LAN access is not needed for MIRAN III, log out after entering the keycode.
- 13** At the Pack Administration menu:
- a.** Select **5**, “Ethernet Configuration”.
  - b.** At the Ethernet Configuration screen, enter the new IP address, subnet mask, Gateway, and IP method of the Succession Media Card, obtained from the network administrator.
- Note:** The IP method can either be ‘bootp’ or ‘static’. To disable the IP connection, but keep MIRAN III working, set the IP method to ‘disabled’. ‘bootp’ is similar to Dynamic Host Configuration Protocol (DHCP).
- c.** Select **Set** to set the LAN configuration parameters.
  - d.** Select **Exit** to return to the Pack Administration screen.
  - e.** Log out of the Text-based User Interface by selecting **9** from the menu screen until the Main Menu screen appears.
- 14** Reboot the Succession Media Card by pressing the reset switch on the front of the pack. This causes the keycode to take effect. Wait for the card to reboot and the Login screen to come up on the maintenance terminal. This takes approximately 90 seconds.

- 15** Use a local DTMF telephone to dial the DID access code for Succession Media Card unit 7.
- Note:** The local DTMF telephone must have an 'unrestricted' Class of Service (CLS = UNR) in Overlay 11.
- a. At the voice prompt, press # (pound key) to establish the call.
  - b. Enter the user name '**user**'=**8737** followed by \* (star symbol).
  - c. At the next voice prompt, enter the password **user0000** followed by \* (star symbol).
  - d. At the main menu, press **5** to access the Record menu.
  - e. Press **5** again to begin recording a RAN announcement.
  - f. When recording is done, press **3** to stop the recording.
  - g. Press **1** to save the announcement.  
Because MIRAN III writes the recording to memory, it can take 30 seconds or longer for MIRAN III to respond that it has saved the announcement.



**CAUTION**  
**Loss of Data**

After pressing **1** to save the announcement, do not hang up. Wait for MIRAN III to state that it has saved the announcement and tagged the announcement with an announcement identifier.

For example: 'Announcement has been saved as announcement 1'.

- 16** Log into the Text-based User Interface through the maintenance terminal as before. Or, if the MIRAN is connected to the LAN, the MIRAN Browser User Interface (BUI) can be accessed by pointing a web browser to the IP address of the Succession Media Card. To assign an announcement to a MIRAN III channel, do the following:
- a. At the Main Menu, select **1** "MIRAN Administration...".
  - b. At the MIRAN Administration menu, select **1** "Announcement Configuration...".
  - c. At the Announcement Configuration menu, select **1** "Calendar Operations...".

- d. At the Calendar Operations menu, select 1 “Calendar Assignment with Descriptor”.
  - e. At the Calendar Assignment with Descriptor screen, first enter the channels (ports) on which a particular announcement is to play. For example, if the TN for a RAN trunk is 20 0 0 5, assign an announcement to channel 5.
  - f. At the ‘Filename:’ prompt, enter the filename of the announcement that must play on the selected channels. Browse the list of available announcements to select one.
  - g. At the ‘Descriptor’ prompt, enter the descriptor that defines when the selected announcement will play on the selected channels. Browse the list of available descriptors to select one. Descriptors can be defined if the pre-configured descriptors do not meet system needs.
  - h. Move the cursor to ‘Add to Calendar’ and press <CR> to create the calendar assignment with descriptor.
- 17 To test RAN announcements, dial the trunk access code for the desired RAN route, and listen to the announcement that plays.

**Note:** With MIRAN III, all changes to MIRAN announcements and configuration are saved automatically.

Refer to Table 12 on page 95 for list of relevant equipment.

————— *End of Procedure* —————

## System configuration

In the system software, configure the following for MIRAN III:

- RAN and Music routes
- a DID route
- trunks for the above routes

To allow synchronization of the time and date between the Meridian 1 and Succession CSE 1000 system and the Succession Media Card, configure the system for LAN access in Overlay 117. Refer to “Configuring Ethernet for Time & Date Synchronization” on page 62 for this procedure.

The Meridian 1 and Succession CSE 1000 system software can be configured either before or after the MIRAN III Succession Media Card is installed. Nortel Networks recommends configuring the system software first, in order to save setup time once the Succession Media Card arrives.

The following sections describe Meridian 1 and Succession CSE 1000 system software configuration for MIRAN III.

## Configuring RAN routes

The Succession Media Card emulates an Enhanced Extended Universal Trunk (EXUT) card in the Meridian 1 and Succession CSE 1000 system. Configure RAN routes and trunks for the Succession Media Card the same way as the EXUT card. For detailed information on Trunk Route Administration (Overlay 16) and Trunk Administration (Overlay 14), see *Administration Input/Output Guide (553-3001-311)*.

To configure the RAN propagation route and the mode of activating the recorded announcement, define its parameters using Trunk Route Administration (Overlay 16). The Succession Media Card emulates the EXUT characteristics and does not require modification of Overlay 16 to configure the MIRAN III functions.

The Succession Media Card and EXUT cards support the following modes of operation:

- Delay Dial Continuous RAN (DDL)
- Immediate Start Continuous RAN (IMM)
- Level Start/Stop RAN (LVL, MLSS, or MLVL)

The Succession Media Card supports the above modes of operation on two, four, or eight independent ports. The same RAN announcement can be assigned to different ports, allowing multiple callers to hear the same announcement at the same time.

**Note:** With Meridian 1 Release 23, and later, and Succession CSE 1000 Release 1, and later, and RAN Broadcast, up to 30 callers can simultaneously listen to the same RAN announcement on a single RAN port.

### Continuous RAN routes (Delay Dial and Immediate Start)

Continuous (immediate or delay) RAN plays an announcement over and over again. Callers “barge in” on an announcement playing on an Immediate Start RAN route. Callers receive a ringback tone for an announcement playing on a Delay Dial RAN route until the announcement begins again. At the end of each announcement, a pulse is issued on the control pulse line used by the trunk unit to cut through to the waiting call. Internal ports and channels wait until the announcement starts to be connected to a RAN announcement.

To configure a continuous RAN route, load the Route Data Block (Overlay 16) using the system TTY, and enter the appropriate responses to the prompts as shown.

**Overlay 16** – Define a continuous RAN route.

Prompt	Response	Description
REQ	NEW CHG	Add new, or change existing configuration.
TYPE	RDB	Route Data Block.
CUST	xx	Customer number.
ROUT	0–511	Route number (0-127 for Succession CSE 1000 and Option 11C).
TKTP	RAN	Recorded Announcement (RAN) TrunkType.
RTYP	CON MCON	Continuous route. Continuous multi-channel (for RAN Broadcast).
- LGTH	4–(60)–7200	Maximum message length in seconds.
- GRD	(IDLE)PLAY	Ground signal from RAN indicates MIRAN is playing (idle). The LGTH and GRD prompts only appear if RTYP = MCON.
REP	1–15	Number of RAN repetitions.
POST	ATT DIS	Route to attendant after maximum repetitions. Disconnect after maximum repetitions.

Prompt	Response	Description
STRT	IMM DDL	Immediately connect call to a recorded announcement. Delay call connection until the start of an announcement.
BDCT	(NO) YES	(Disallows) allows broadcast capability. The BDCT prompt appears only if the customer has RAN Broadcast (RANBRD) package 327.
ASUP	(NO) YES CO	Does not return Answer Supervision. Returns Answer Supervision. Returns Answer Supervision if originator is a CO trunk.
ACOD	xxx...x	Trunk route access code

**Multi-channel level start/stop RAN route**

In the multi-channel level start/stop control RAN, the leading edge of the start signal initiates announcement playback that continues until either the trailing edge of the start signal occurs or the end of the announcement is reached. If the trailing edge of a level start signal terminates an announcement, it resets immediately and is again available for playback. The multi-channel level start/stop control RAN mode allows the same announcement to be played over multiple RAN channels independently specify multi-channel using the same RAN route. See “Example 2:” on page 101.

To configure this RAN route, load Overlay 16 using the system TTY, and enter the appropriate responses to the prompts as shown.

**Overlay 16 – Define a multi-channel level start/stop RAN route.**

Prompt	Response	Description
REQ	NEW CHG	Add new, or change existing configuration.
TYPE	RDB	Route Data Block.
CUST	xx	Customer number.
ROUT	0-511	Route number (0-127 for Succession CSE 1000 and Option 11C)



Prompt	Response	Description
TKTP	RAN	Recorded Announcement (RAN) Trunk Type
RTYP	MLSS MLVL	Multi-channel level start/stop RAN. Level start/stop, multi-channel (for RAN Broadcast). Sets RTYP to MLVL with RAN Broadcast, even if the broadcast capability (BDCT = NO) is denied for this route.
- LGTH	4–(60)–7200	Maximum message length in seconds. The LGTH and GRD prompts appear only if RTYP = MCON.
- GRD	(IDLE) PLAY	Ground signal from RAN indicates MIRAN is playing (idle).
REP	1–15	Number of repetitions of RAN.
POST	ATT DIS	Route to attendant after maximum repetitions. Disconnects after maximum repetitions.
STRT	IMM	Immediately connects call to recorded announcement.
BDCT	(NO) YES	(Disallows)a llows broadcast capability. The BDCT prompt appears only if using the RAN Broadcast (RAN BRD) package 327.
ASUP	NO YES CO	Does not return Answer Supervision. Returns Answer Supervision. Returns Answer Supervision for a CO trunk.
ACOD	xxx...x	Trunk route access code

Multi-Level Start/Stop RAN (MLSS or MLVL) allows multiple start/stop RAN channels to be supported within the same RAN route.

### Level start/stop RAN route

In the immediate “level” start RAN, the leading edge of the start signal initiates announcement playback. The playback continues until either the trailing edge of the start signal occurs or the announcement ends. If the trailing edge of a level start signal terminates an announcement, it resets immediately and is again available for playback.

To configure this RAN route, load Overlay 16 using the system TTY, and enter the appropriate responses to the prompts as shown.

**Overlay 16** – Define a level start/stop RAN route.

Prompt	Response	Description
REQ	NEW CHG	Define new, or change existing configuration.
TYPE	RDB	Route Data Block.
CUST	xx	Customer number.
ROUT	0–511	Route number (0-127 for Succession CSE 100 and Option 11C)
TKTP	RAN	Recorded Announcement (RAN) Trunk Type.
RTYP	LVL	Level start/stop mode.
REP	1–15	Number of RAN repetitions.
POST	ATT DIS	Route to attendant after maximum repetitions. Disconnects after maximum repetitions
STRT	IMM	Immediately connects call to recorded announcement.
ASUP	NO YES CO	Does not return Answer Supervision. Returns Answer Supervision. Returns Answer Supervision if the originator is a CO trunk.
ACOD	xxx...x	Trunk route access code.

**Music-On-Hold activation and route configuration**

Music-On-Hold (MOH) operates in a continuous mode with an immediate connection to the music source. The music source plays continuously. Callers “barge in” on playing music.

To specify the conference loop for MOH, load the Configuration Record (Overlay 17), and enter the appropriate responses to the prompts as shown.

**Overlay 17** – Add or change conference loop for MOH.

Prompt	Response	Description
REQ	CHG	Change existing configuration.
TYPE	CEQU	Record Common Equipment.
CEQU	(NO) YES	Changes Common Equipment parameters.
XCT	0–158	Loop number for NT8D17 Conference/TDS card.
CONF	0–158	Conference loop should be an even number.

To configure the MOH route, load Route Data Block (Overlay 16) using the system TTY, and enter the appropriate responses to the prompts as shown.

**Overlay 16** – Define the Music-On-Hold route.

Prompt	Response	Description
REQ	NEW CHG	Add new, or change existing configuration.
TYPE	RDB	Route Data Block.
CUST	xx	Customer number.
ROUT	0–511	Route number (0-127 for Option 11C).
TKTP	COT, MUS	MOH Trunk Types.
MUS	(NO) YES	Music-On-Hold.
_MRT	0–511	Music route number.
STRT	IMM	Immediately connects a call to Music-On-Hold.
ICOG	OGT	For Music-On-Hold, selects the outgoing trunk only.
BDCT	(NO) YES	(Denies) allows broadcast capability. The BDCT prompt appears only if using the Music Broadcast (MUSBRD) package 328. If BDCT = YES, no conference loop is necessary; each music trunk has 64 broadcast connections.

Prompt	Response	Description
ASUP	NO YES CO	Does not return Answer Supervision. Returns Answer Supervision. Returns Answer Supervision if originator is a CO trunk.
ACOD	xxx...x	Trunk route access code

### Configuring the DID route for the TUI

To configure a Succession Media Card for TUI access, using internal one-to-one port 7, configure the appropriate route and trunk data blocks. Route Data Block program Overlay 16 commands define the DID route data block.

#### Overlay 16 – Define a DID route for the TUI.

Prompt	Response	Description
REQ	NEW CHG	Add new, or change existing configuration.
TYPE	RDB	Route Data Block.
CUST	xx	Customer number.
ROUT	0–511	Route number.
TKTP	DID	Trunk type for telephone-based OA&M access.
ICOG	IAO	Incoming and outgoing trunk.
ACOD	xxx...x	Trunk route access code.
CNTL	YES	Gate opener for control timers
NEDC	ETH	Near End Disconnected Control. Both ends have disconnect control.
FEDC	ETH	Far End Disconnected Control. Both ends have disconnect control.
MANO	YES	Manual Outgoing Trunk Route.

## Configuring the MIRAN trunks

After a RAN, Music, or DID route is configured, configure the route's corresponding trunk. A trunk data block specifies the parameters for a particular trunk. Because the Succession Media Card emulates the EXUT card, define the Succession Media Card parameters using Overlay 14 on the system TTY. Respond to the appropriate prompts in Overlay 14 to configure the MIRAN III trunk data block.

**Overlay 14** – Configure the MIRAN III trunk data block for RAN, MOH, and DID.

Prompt	Response	Description
REQ	NEW	Add new data.
TYPE	RAN DID	Type of trunk music: Recorded Announcement Direct Inward Dialing
TN	l s c u	Terminal NUMBER. MIRAN loop, shelf, card, and unit. The DID trunk on unit (port) 7 must be configured in order to use the TUI. The Succession Media Card comes from the factory with approximately 6 minutes of royalty-free music pre-configured on port 0. Unit 0 can be configured as a Music trunk to make easy use of the royalty-free music.
XTRK	EXUT	Enhanced Extended Universal Trunk Card.
CUST	xx	Customer number as defined in Overlay 15. Customer is prompted when REQ = NEW.
RTMB	xxx yy	Route (0-511) and member (1-254) number.
CONN	(4)–48	The maximum number of broadcast connections allowed for this trunk. The 'CONN' prompt only appears if BDCT = YES in Overlay 16.
SIGL	LDR	Signaling for battery or loop outputting for telephone-based OA&M over the Succession Media Card port 7.

Prompt	Response	Description
BIMP	600 900	Balanced trunk impedance for the Succession Media Card.
STRI	DDL IMM	Incoming trunk starting arrangement.
STRO	DDL IMM	Outgoing trunk starting arrangement. Do not program MUS or DID trunks as Delayed Dial (DDL).
CFLP	0-159	Music conference loop.

## Configuring Ethernet for Time & Date Synchronization

The time and date synchronization over the LAN requires the connection of the system to a LAN environment. Time and Date Synchronization requires Meridian 1 Release 22, or later, and Succession CSE 1000 Release 1, or later.

*Note:* Refer to “Time & Date Configuration menu” on page 208 for instructions on configuring Time & Date Synchronization.

## Limited access password

MIRAN III uses a default Limited Access Password (LAPW) and ID to access Overlay 2. This allows a task running on MIRAN III to remotely log into access Overlay 2, and extract the system time and date from the Meridian 1 and Succession CSE 1000.

## Basic MIRAN III installation

### Installation overview

The MIRAN III Succession Media Card operates on the following systems:

- Meridian 1 Options 51C, 61C, 81, and 81C
- Option 11C and 11C Mini
- Succession CSE 1000

Refer to “Software requirements” on page 86 for more information.

## Installing a MIRAN III Succession Media Card

To install a Succession Media Card, follow the general procedures listed below:

- Prepare the site.
- Unpack, inspect, and take inventory of the equipment.
- Install the Succession Media Card in the selected card slot, if it is not already installed.
- Install the cables between the Succession Media Card faceplate connectors and external devices, if required.
- Install the cables to the I/O panel connector at the rear of the module, if required.
- Cross-connect external devices to the Succession Media Card through the Audio-adaptor (for example, trunk cards, CD player, and cassette player).

## Installation preparation

To prepare for Succession Media Card installation, unpack and inspect components. Take inventory and locate the card slots where the Succession Media Card will be installed.

### Unpacking and inspection

Unpack and inspect the equipment for damage. When unpacking, follow the general precautions recommended by computer and telephone equipment manufacturers:

- Remove items that generate static charge from the installation site.
- Wear an anti-static wrist wrap before handling any equipment.
- Remove equipment carefully from its packaging.
- Visually inspect the equipment for obvious faults or damage.

### Taking inventory

Verify that all equipment is at the site before you begin installation. Check the equipment received against the shipping documents.

### Locating the card slot

A Succession Media Card can be installed in any IPE card slot in an IPE module or shelf that has a 25-pair tip/ring cable connected between the backplane and the I/O panel. The only slot that cannot be used is the Peripheral Controller card slot labeled *Cont.*

**Note:** IPE card slots 0, 4, 8, and 12 are already pre-configured for Succession Media Card installation.

In the Option 11C cabinet, the Succession Media Card can be installed in card slots 1 to 10 of the Main Cabinet and in slots 11 to 50 in the Expansion Cabinet(s). Refer to “Overlay 17 – Add or change conference loop for MOH.” on page 59.

In the Option 11C Mini, the Succession Media Card can be installed in slots 1 to 3 of the Main Chassis and in slots 7 to 10 of the Chassis Expander.

In the Succession CSE 1000, the Succession Media Card can be installed in slots 1 to 3 of the Succession Media Gateway and in slots 7 to 10 of the Succession Media Gateway Expansion

**Note:** If the backplane RS-232 connections are to be used, refer to Appendix C: “NT8D37 cable connections” on page 283 for NT8D37 ribbon cable connection configuration on the backplane.

## Succession Media Card installation in an IPE shelf

Before installing the card, inspect the IPE module or cabinet I/O panel for backplane cabling.



### **CAUTION**

#### **Damage to Equipment**

Before installing a Succession Media Card in a card slot, ensure that no cross-connect wires from the Succession Media Card or another product remain attached to this slot. Cross-connect wires that carry a ringing voltage can damage the Succession Media Card.



To install the Succession Media Cards in an IPE shelf, follow the steps in Procedure 2.

**Procedure 2**  
**Installing Succession Media Cards in an IPE shelf**

- 1 Identify the IPE card slot(s) selected for Succession Media Card(s).
- 2 Pull the top and bottom extractors away from the Succession Media Card faceplate.
- 3 Insert the Succession Media Card into the card guides and gently push it until it makes contact with the backplane connector.
- 4 Push the top and bottom extractors firmly towards the faceplate to insert the Succession Media Card into the faceplate connector and to lock it firmly in place.
- 5 Observe the faceplate hexadecimal display. It indicates the progress of the internal self-test in the form of **T:xx**. See “Succession Media Card hexadecimal codes” on page 271. Upon successful completion of the test and the start-up of the RAN application, the display shows the code **MRN3**.

**Note 1:** During the MIRAN bootup sequence, either an error message or the ‘**T:xx**’ self-test messages are seen on the hex display. To interpret an error message, refer to “Succession Media Card hexadecimal codes” on page 271.

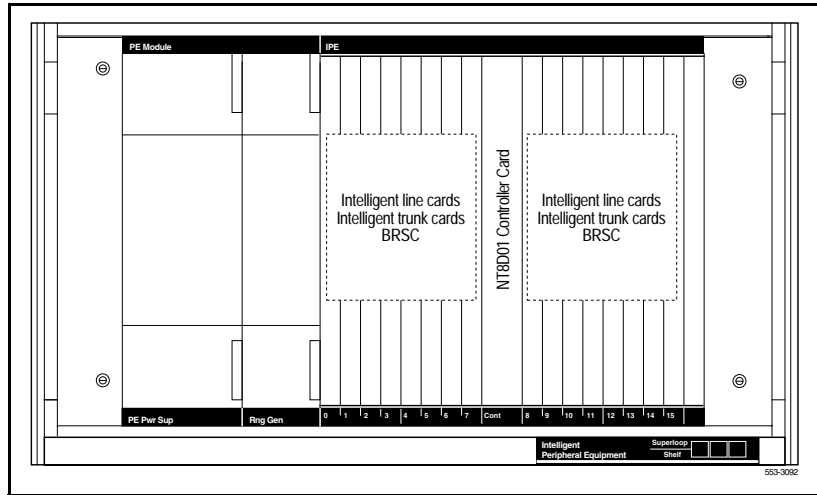
**Note 2:** If the Media Card is being booted for the very first time, the cards boot in BOOTP mode. If a BOOTP server is not being used, the card continues to search for a BOOTP server on the network, stalling the boot process. At this point, users that are not using a BOOTP server should enter the key sequence +++ (plus symbols) in order to force booting to continue. Once booted, users should change the IP method to either disabled or static (see Procedure 8 on page 73 and Procedure 9 on page 74). Once the IP method is changed to disabled or static, subsequent boots of the card do not look for a BOOTP server.

- 6 To enable the Succession Media Card, load the Network and PE Diagnostic program (Overlay 32) into the system memory using the system TTY. Execute the **ENLC l s c** command, where **l** is the loop, **s** is the module or shelf, and **c** is the card to enable.
- 7 Repeat steps 1 through 6 for each additional Succession Media Card.

————— *End of Procedure* —————

Figure 9 shows the IPE module and the card slots where the IPE cards reside. A Succession Media Card can be installed in any IPE card slot, except the Peripheral Controller (Cont) card slot.

**Figure 9**  
The NT8D37 IPE module

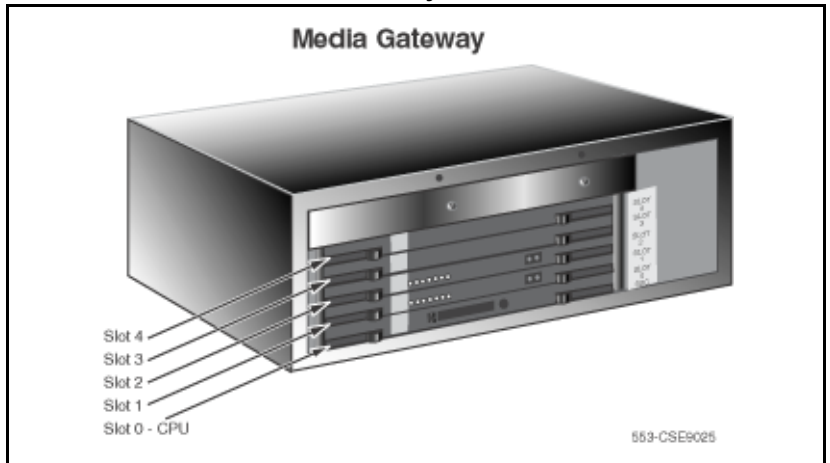


**Note 1:** European customers who require MIRAN LAN capability must install the Succession Media Card in slots 0, 4, 8, or 12 of the IPE shelf.

**Note 2:** If using either the NT8D37AA/DC IPE or the NT8D11AC/DC CE/PE module, and the Maintenance Serial port is needed, the Succession Media Card cannot be installed in slots 3, 7, 11, or 15 of the IPE shelf. The necessary tip/ring pairs in these slots are not available.

Figure 10 show the Succession CSE 1000 Media Gateway Chassis.

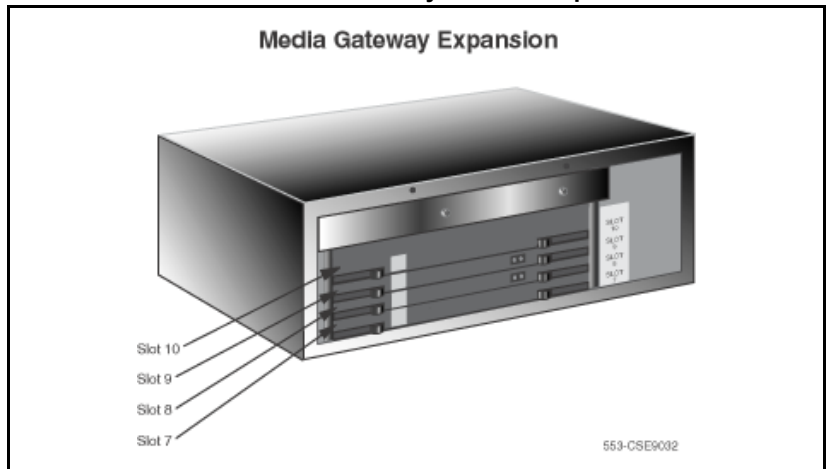
**Figure 10**  
**Succession CSE 1000 Media Gateway Chassis**



*Note:* Slot 4 cannot be used in this Media Gateway.

Figure 11 shows the Succession CSE Media Gateway Chassis Expansion.

**Figure 11**  
**Succession CSE 1000 Media Gateway Chassis Expansion**



## Succession Media Card installation in the Option 11C, 11C Mini, and Succession CSE 1000

Before installing the Succession Media Card, inspect the Option 11C module or cabinet I/O panel for backplane cabling.



### **CAUTION**

#### **Damage to Equipment**

Before installing a Succession Media Card into a card slot, ensure that no cross-connect wires from the Succession Media Card or another product remain attached to this slot. Cross-connect wires that carry a ringing voltage can damage the Succession Media Card.

To install one or more Succession Media Cards in the Option 11C, 11C Mini and Succession CSE 1000 system, follow the steps in Procedure 3.

### **Procedure 3**

#### **Installing one or more Succession Media Cards in the Option 11C, 11C Mini, and Succession CSE 1000**

- 1 Identify the card slot(s) selected for the Succession Media Card(s).
- 2 Pull the top and bottom extractors away from the Succession Media Card faceplate.
- 3 Insert the Succession Media Card into the card guides and gently push it until it makes contact with the backplane connector.
- 4 Push the top and the bottom extractors firmly towards the faceplate to insert the Succession Media Card into the faceplate connector and to lock it firmly in place.
- 5 Observe the faceplate hexadecimal display. It indicates the progress of the internal self-test in the form of **T:xx**. Refer to “Succession Media Card hexadecimal codes” on page 271. Upon successful completion of the test and the start-up of the RAN application, it displays the code **MRN3**.

**Note 1:** During the MIRAN bootup sequence either an error message or the 'T:xx' self-test messages are seen on the hex display. To interpret an error message, refer to "Succession Media Card hexadecimal codes" on page 271.

**Note 2:** If the Media Card is being booted for the very first time, the cards boot in BOOTP mode. If a BOOTP server is not being used, the card continue to search for a BOOTP server on the network, stalling the boot process. At this point, users that are not using a BOOTP server must enter the key sequence +++ (plus symbols) in order to force booting to continue. Once booted, users should change the IP method to either disabled or static (see Procedure 8 on page 73 and Procedure 9 on page 74). Once the IP method is changed to disabled or static, subsequent boots of the card do not look for a BOOTP server.

- 6 To enable the Succession Media Card, load the Network and PE Diagnostic program (Overlay 32) into the system memory using the system TTY. Execute the **ENLC c** command, where **c** is the card to enable.
- 7 Repeat steps 1 through 6 for each additional Succession Media Card.

————— *End of Procedure* —————

A VT100-type (maintenance) terminal must be connected to the Succession Media Card to perform the following OA&M functions during installation and setup:

#### **Procedure 4**

#### **Connecting a VT100-type terminal to the Succession Media Card**

- 1 Enter keycode information.
- 2 Enter the IP address, subnet mask, and Gateway information for the LAN configuration.

————— *End of Procedure* —————

The VT100-type terminal can also be used to perform any of the other OA&M functions. The VT100-type terminal uses the Succession Media Card's Text-based User Interface to perform OA&M. Refer to "RAN Application: Text-based User Interface" on page 153 for more information on the Text-based User Interface.

For terminal-based OA&M access, specify the VT-100 type terminal interface characteristics to ensure compatibility with the Succession Media Card RS-232 interface.

Set the interface parameters as follows:

- Transmission speed: 9600 bps
- Data bits: 8
- Stop bit: 1
- Parity: No
- Flow control: none

MIRAN III uses the HyperTerminal application. This application allows the user to disable the CTRL and arrow keys, as these keys are used by OA&M for navigating the menus.

### **Connecting a terminal to the Succession Media Card in the IPE module**

To connect a terminal to the Succession Media Card in the IPE module, the following options are available:

- connecting directly to the Succession Media Card faceplate
- connecting directly to the Succession Media Card Audio-adaptor
- connecting to the Succession Media Card Audio-adaptor through a modem

### ***Connecting the terminal directly to the faceplate connector or Audio-adaptor***

The Succession Media Card has an 8-pin mini-DIN connector at the bottom of the faceplate. This connector can be used to connect a terminal. The terminal can also be connected to the RS-232 maintenance connection on the Succession Media Card Audio-adaptor.

To connect the terminal or a personal computer emulating a terminal to the 8-pin mini-DIN connector on the Succession Media Card faceplate or on the Audio-adaptor, follow the steps in Procedure 5.

**Procedure 5**  
**Connecting the terminal to directly to the faceplate connector or Audio-adaptor**

- 1 Place the terminal in the desired location. If the distance to the Succession Media Card is less than 10 ft (3 m), an extension cable is not needed.
- 2 Plug the 8-pin mini-DIN male connector of the NTAG81CA Maintenance cable into the Succession Media Card 8-pin mini-DIN female connector located at the bottom of the faceplate or on the Audio-adaptor.
- 3 Plug the NTAG81CA cable DB-9 female connector into the terminal. If the terminal requires a different connector, install an adaptor cable or a compact adaptor between the terminal and the NTAG81CA cable.
- 4 If the terminal is more than 10 ft (3 m) from the Succession Media Card, use the 16-foot NTAG81BA Maintenance Extender Cable. If the terminal requires a different connector, use an adaptor cable of the appropriate length.

————— *End of Procedure* —————

To connect a modem to the maintenance connection on the Succession Media Card Audio-adaptor, follow the steps in Procedure 6:

**Procedure 6**  
**Connecting a modem to Audio-adaptor**

- 1 Place the modem in the desired location.
- 2 Plug the modem cable into the 9-way D-sub connector on the Audio-adaptor.

————— *End of Procedure* —————

For additional information on how to set up the modem, refer to “MIRAN III Succession Media Card interface connectors” on page 272.

## Connecting an external audio device

An analog audio source and receiver can be connected to the Succession Media Card for the following purposes:

- recording music or announcements to file
- connecting directly through a trunk emulation port/channel into the Meridian 1 and Succession CSE 1000 for MOH

The analog device can be connected to the audio port on the Succession Media Card Audio-adaptor.

### Analog to internal pass-thru switchover

For Music-On-Hold, the analog port can be used to assign music from an external source to internal channels.

To allow switching from the analog source to an internal channel, the configuration of each channel is polled every 30 seconds to check for an assignment switchover.

If the assignment is for a voice file, the playthrough is stopped and the voice file started immediately. The opposite is also possible. This switchover always occurs at the end of the file to avoid hearing truncated announcements.

The Succession Media Card Audio-adaptor has an audio jack that provides one audio input.

To connect the external audio source to the Succession Media Card Audio-adaptor audio jack, follow the steps in Procedure 7:

#### Procedure 7

##### Connecting audio devices to the Succession Media Card faceplate

- 1 Plug the 3.5 mm jack on the common side of the NTAG81AA Audio Cable into the 3.5 mm Audio Jack on the Succession Media Card backplane.
- 2 Plug the audio input end of the NTAG81AA cable connector into the audio source device. If the source is at a distance from the Succession Media Card, an extension may have to be used (not supplied).



- 3 Plug the audio output end of the NTAG81AA cable connector into the audio receiver device for announcement backup. If the source is at a distance from the Succession Media Card, an extension may have to be used (not supplied).

**Note:** For the Succession Media Card, a standard 3.5 mm stereo audio jack can be used to provide an external audio source.

————— *End of Procedure* —————

## LAN access installation and setup

The Succession Media Card (NT0966) can be connected to a LAN. The LAN access to the Succession Media Card provides the ability to:

- access the card through a common web browser to perform OA&M functions
- perform FTP uploads and downloads of files to and from the card
- telnet to the card from a remote site

**Note:** LAN access to MIRAN III is optional. LAN access is not necessary to perform any of the OA&M functions through the Text-based User Interface.

The following sections describe the procedures for setting up and using the MIRAN III LAN capability.

To enable the LAN capabilities, follow the steps in Procedure 8.

### **Procedure 8** **Enabling the LAN capabilities**

- 1 For LAN Configuration options, refer to “Ethernet/LAN requirements” on page 96.
- 2 Obtain the IP address, subnet mask, gateway, and IP method from the system administrator.

**Note:** The IP method can either be ‘bootp’ or ‘static’. To disable the IP connection, but keep the Succession Media Card working, set the IP method to ‘disabled’. ‘bootp’ is similar to Dynamic Host Configuration Protocol (DHCP).

- 3 Install the Succession Media Card in the appropriate slot.
- 4 Connect the VT100-type maintenance terminal.

————— *End of Procedure* —————

To configure the IP address, subnet mask, Gateway, and IP method for the Succession Media Card, follow the steps in Procedure 9:

**Procedure 9**

**Configuring the IP address, subnet mask, Gateway and IP method**

- 1 Log in to the MIRAN III Text-based User Interface by entering the user name and password and selecting **-Login-** at the login screen. Refer to “Login screen” on page 158 for further information.
- 2 At the Main Menu, select **-2-** to access the Pack Administration menu.
- 3 At the Pack Administration menu, select **-5-** to access the Ethernet Configuration screen.
- 4 At the Ethernet Configuration screen, enter the new IP address, subnet mask, gateway, and IP method. This new information writes over any old LAN configuration information that the card contains.
- 5 Select **-Set-** to set the new LAN configuration information. A confirmation notice at the bottom of the Ethernet Configuration screen indicates successful completion of the task. Refer to “Ethernet Configuration screen” on page 206 for further information.
- 6 Reboot the Succession Media Card to activate the new LAN configuration.

————— *End of Procedure* —————

After installing the Audio-adaptor and configuring the IP address, subnet mask, and gateway for the Succession Media Card, the Browser User Interface (BUI) can be accessed. To access the BUI, use a standard web browser that supports HTML frames. Nortel Networks recommends using a minimum of Netscape Communicator 4.7 or Internet Explorer 4.0.

To access the MIRAN III BUI, follow the steps in Procedure 10:

**Procedure 10**  
**Accessing the MIRAN III BUI**

- 1 Enter the IP address of the card in the URL address field of the browser. The MIRAN III BUI login screen appears.
- 2 Select the username; **admin** is the default.
- 3 Enter the password; **admin000** is the default password for **admin**.
- 4 Click on the **Login** button. If login is successful, a confirmation message appears.
- 5 Click on **Main Menu**. The main MIRAN Administration page appears.

————— *End of Procedure* —————

After accessing the BUI, OA&M functions can be performed.

The LAN connection to the Succession Media Card enables a user to telnet to the Text-based User Interface (see page 153) from a remote site and interact with the Succession Media Card in the same way as using a local maintenance terminal.

To telnet to the Succession Media Card, follow the steps in Procedure 11.

**Procedure 11**  
**Telneting to the Succession Media Card**

- 1 Use the telnet command from any Operating System's command line.
- 2 Use the HyperTerminal program.

————— *End of Procedure* —————

## **FTP downloads and uploads**

LAN connection to the Succession Media Card allows the transfer of files to and from the card using File Transfer Protocol (FTP). To use the FTP capability, the following are required:

- a connection of the Succession Media Card to the LAN through the Succession Media Card Audio-adaptor
- a permanent assignment of an IP address to the card

- a valid user name and password with which to access the card
- a standard FTP client application. (The figures in this section show the use of the WS\_FTP Professional file transfer client.)

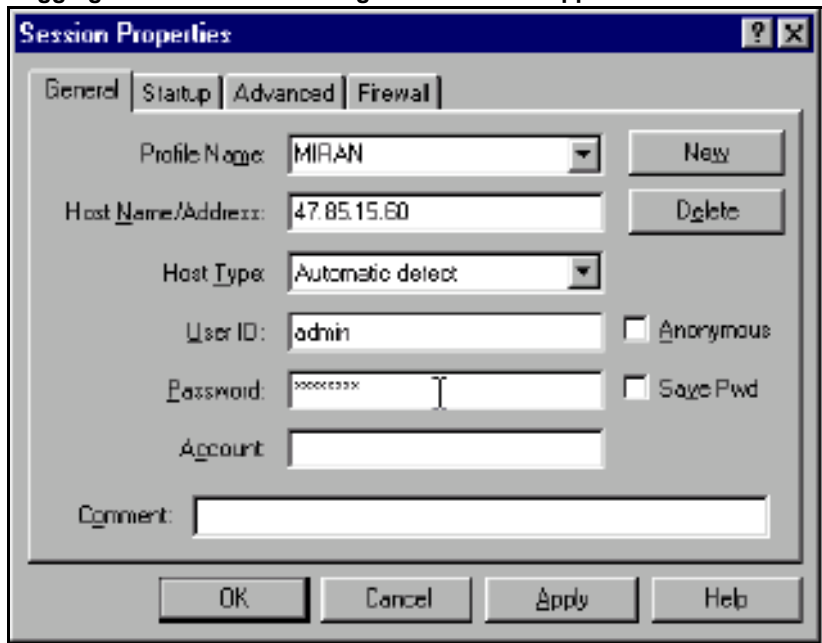
To transfer files to and from the Succession Media Card using FTP, follow the steps in Procedure 12.

**Procedure 12**

**To transfer files to and from the Succession Media Card using FTP**

- 1 Open the FTP client application. Select **Connect** to open a dialog box similar to the one shown in Figure 12.

**Figure 12**  
**Logging in to the MIRAN through an FTP client application**

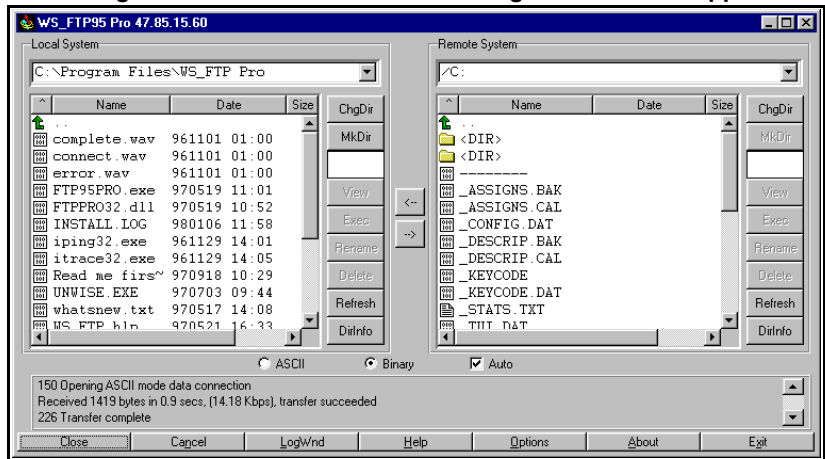


- 2 Enter the IP address of the Succession Media Card in the Host Name/Address field.
- 3 Enter the user name and password for the card. This is the same user name and password used to log in to the Text-based User Interface.

- 4 Click **OK** to connect to the Succession Media Card. A dialog box appears (similar to Figure 13). From here, files can be transferred to and from the card using FTP.

*End of Procedure*

**Figure 13**  
**Accessing the Succession Media Card through an FTP client application**



**Note 1:** Select 'ASCII' format for the transfer of text files and 'Binary' format for the transfer of all other files.

**Note 2:** If a .WAV file is copied to the Succession Media Card, remember the .WAV file must be converted to .ALW or .ULW format before an assignment can be created for the file. Refer to "Convert Announcement File screen" on page 183 for instructions on converting sound files.

The Remote System lists the files in the C: drive of the Succession Media Card. If files must be transferred to or from the A: drive, select the 'Change Directory' option on the FTP client application. Enter /A: as the new directory name.

The FTP client application can also be used to perform file maintenance functions on the Succession Media Card, such as:

- renaming or deleting files
- creating or deleting sub-directories

Most FTP client applications also allow profiles to be created for addresses that are frequently accessed. Use this capability to create a profile for each Succession Media Card in the network. This prevents having to enter the IP address, the user name, and the password each time a card is accessed.

## Performing upgrades and replacements

Administration tasks can include upgrading RAN applications and performing backups. Upgrades can include:

- storage capacity expansion
- channel capacity expansion

### PC Card Backups

Backup is available to a PC Card, if required. The configuration must be backed up. Refer to “Backup Configuration screen” on page 186.

Insert a blank PC Card into the A: drive, as though increasing the messaging storage capacity. Use the **BACKUP** command on the Command line.

For details, refer to “RAN Application: Text-based User Interface” on page 153 and “RAN Application: Telephone User Interface” on page 239. The new card is now available as a backup medium rather than as a storage medium.

If a backup is done to a non-blank card, the existing files are overwritten.

*Note:* When backing up recordings and configuration, define the drive to use for backup.

Backups save configuration files. The configuration files contain information relating to the RAN/music PCM data stored on file that includes:

- announcement-to-channel allocation
- passwords
- configuration variables

## Restoring configuration

When MIRAN III is rebooted, the MIRAN III configuration is restored from the disk using the A: drive first and then the C: drive.

## RAN upgrades

Two types of upgrade are available for MIRAN III:

- a software upgrade for a bug fix and/or addition of new features
- a memory upgrade to increase the voice storage capacity

To perform a local software upgrade, follow the steps in Procedure 13.

### Procedure 13

#### Local software upgrade

- 1 Insert the new feature PC Card into the A: drive slot on the Succession Media Card.

**Note:** The configuration file can be prepared in the distributor's office for each MIRAN III customer and then placed on the PC Card, along with the application and/or recorded announcements to be upgraded. Then, the PC Card is sent to the customer, who inserts the PC Card into the Succession Media Card and performs the upgrade procedure.

- 2 Initiate the upgrade by using the "Software Upgrade screen" on page 200. The MIRAN III copies across the new application while maintaining all files from the existing ATA Flash memory that are still needed, such as existing recorded announcements and configuration.
- 3 Once the upgrade is complete, remove the old Flash card, unless it is needed to provide additional storage capacity.
- 4 Enter the new keycode on the MIRAN III terminal to activate new features just installed.

**Note 1:** If the software upgrade is a maintenance type (for example, a bug fix), a new keycode is not needed.

**Note 2:** If the upgrade consists of a new application or enhancement, the administrator must enter a new keycode on the maintenance terminal to enable the upgrade.

- 5 Perform a cold reboot to activate the new feature(s).

————— *End of Procedure* —————

To upgrade Succession Media Cards remotely from any location on the customer's network, follow the steps in Procedure 14.

**Procedure 14**  
**Remote software upgrade**

- 1 Log in to the card using an administrator level password. The access can be either through Telnet or through a modem connection.
- 2 Download the software upgrade binary over the network using FTP. Sufficient space must be available on the Succession Media Card.
- 3 Enter the software upgrade menu in the Text-based user interface through a serial or a telnet connection, and call up the file that was just downloaded. Complete the upgrade using "Software Upgrade screen" on page 200.
- 4 Enter the new keycode on the MIRAN terminal to activate new features just installed.

**Note 1:** If the software upgrade is a maintenance type, such as bug fix, a new keycode is not needed.

**Note 2:** If the upgrade consists of a new application or enhancement, the administrator must enter a new keycode on the maintenance terminal to enable the upgrade.

- 5 Perform a cold reboot to activate the new feature(s).

————— *End of Procedure* —————

**Increasing voice storage**

The voice storage capacity can be increased to the maximum amount available on commercially available PC Cards (up to five hours).

To expand the announcement storage capacity, insert a blank PC Card in the A: drive slot on the faceplate. The Succession Media Card software checks the memory card for formatting information. If none exists, the Succession Media Card formats the card in DOS format. When completed, the full capacity of the card is available for storage.



---

## Recording announcements remotely for use on the MIRAN III Succession Media Card

MIRAN III enables a customer to record announcements on a remote PC, and then transfer them, using FTP, to the MIRAN III Succession Media Cards that reside in different locations. Through the MIRAN BUI, the announcements can also be assigned to the various MIRAN III Succession Media Cards from the same remote PC.

For recording announcement files on a PC, Nortel Networks recommends the GoldWave™ shareware.

To record an announcement on a PC using GoldWave, follow the steps in Procedure 15.

### Procedure 15 Recording an announcement

- 1 At the GoldWave window, go to the “Options” menu on the toolbar and select “File types”. In the filename extension, insert “**snd**”; set “Rate (Hz)” to “**8000**”; set “Format:” to “**PCM**”; and set “Attributes:” to “**8-bit, mono, unsigned**”. Click the OS Associate box and close the window.
- 2 Click the new icon on the toolbar. Select “voice” under quick settings, select “mono” under channels, and select the desired length of the announcement. Close the window.
- 3 Go to tools on the toolbar and select “Device controls”. Press the red button to begin recording. Press the red button again to finish the recording.

**Note:** Use the “Help” menu to select the recording device.

- 4 Go to “Effects” on the toolbar and select “Resample”. Change “Rate (Hz)” to “**8000**”. Select “OK”.
- 5 Go to “File” on the toolbar and select “Save as”. Input the desired filename; select the file type, either “\*.snd” or “\*.raw”; and select “μ-law, mono”, or “a-law mono” in the “File Attributes:”. Select “Save”.
- 6 Go to Windows Explorer, locate the file, and rename the file extension to “.ulw” (or “.alw”, if appropriate).

- 7 Transfer the recording to a PC Card or send it by FTP to the MIRAN III Succession Media Card's C: drive. Once the recording is on the Succession Media Card's C: drive, assign it to any available MIRAN III Succession Media Card channel.

**Note:** Remember to send announcement files as type "Binary" by using FTP.

As an alternative to step 5, save the file as type "\*.wav" instead of "\*.snd" or "\*.raw". Then skip step 6 and transfer the .wav file to the Succession Media Card's C: drive as described in step 7. However, once the .wav file is on the C: drive, it must be converted to  $\mu$ -law or a-law format before the announcement can be assigned to a MIRAN III Succession Media Card channel. See "Convert Announcement File screen" on page 183.

————— *End of Procedure* —————

To replace old announcement files with the new files that are on the PC Card, follow the steps in Procedure 16.

**Procedure 16**  
**Replacing old announcement files**

- 1 Display existing (old) files by accessing the File Explorer screen from the File Commands menu. See "File Commands menu" on page 191.
- 2 Delete the files to be replaced. See "Delete File screen" on page 195.
- 3 Copy new files from the PC Card into the drive where the other announcement files are located. See "The Copy File screen" on page 193.
- 4 Convert files from .WAV to .ULW or .ALW, or convert files from .ULW or .ALW to .WAV, if required. See "Convert Announcement File screen" on page 183.
- 5 Professionally recorded prompts must be in .WAV, .ALW, or .ULW format. See "Record Announcement from External Channel screen" on page 182. Also see "Sound recording configuration" on page 269.

————— *End of Procedure* —————

## Foreign language prompt

The MIRAN III application Telephone User Interface uses English language prompts by default. The application can be configured to operate with French, German, and Italian prompts. The appropriate language prompts files can be downloaded from the Nortel Networks web site.

To change the language prompts used by the Telephone User Interface, follow the steps in Procedure 17:

### Procedure 17

#### Changing language prompts used by the Telephone User Interface

- 1 Create a directory on the C: (internal) drive or A: (PC Card) drive. This can be achieved by accessing the “Make Directory” link on the BUI navigator tree or by the Text User Interface. Enter the directory name as FRENCH, GERMAN, or ITALIAN.
- 2 Download the prompts from the web site into the respective directory.
- 3 Go to the “Configuration Variables Modify” page on the BUI. Select the “Language” variable.
- 4 Change the “Language” variable to FRENCH, GERMAN, or ITALIAN, and click modify. This modification can be verified by going to the Configuration Variables View.
- 5 The prompts on the Telephone User Interface will now be in the language defined in the “Language” Configuration Variable.

**Note:** English language prompts are the default and are part of the MIRAN III application. If the language is changed to English (for example, the English prompts do not need to be downloaded).

---

*End of Procedure*

---



---

# Engineering guidelines

---

## Contents

This section contains information on the following topics:

Software requirements. . . . .	86
For users with Release 23 and Succession CSE 1000 Release 1 or later, and RAN Broadcast. . . . .	86
For users with Release 22.08 or 21.41 and earlier . . . . .	88
For users with Release 21.45 or 22.16 and later, but without RAN Broadcast. . . . .	89
MIRAN III requirements. . . . .	89
MIRAN III Succession Media Card channel capacity options. . . . .	90
MIRAN III Succession Media Card listener capacity options. . . . .	90
Supported RAN modes. . . . .	91
Voice storage capacity. . . . .	92
Power and ground requirements. . . . .	92
External equipment requirements. . . . .	93
Maintenance terminal requirements. . . . .	94
Telephone for OA&M access. . . . .	94
External analog sources. . . . .	95
Succession Media Card hardware list. . . . .	95
Ethernet/LAN requirements. . . . .	96
Engineering MIRAN III Succession Media Card and music application.	101

## Reference list

The following are the references in this section:

- *System Engineering* (553-3001-151)

- *Planning and Engineering Guidelines (553-3020-149)*
- *Features and Services (553-3001-306)*

## Introduction

Meridian 1 general system engineering guidelines are described in *System Engineering (553-3001-151)*. Succession CSE 1000 general system engineering guidelines are described in *Succession CSE 1000 Planning and Engineering Guide (553-3023-149)*. The following information deals specifically with the engineering guidelines for MIRAN III planning and implementation. For MIRAN III technical characteristics, refer to Appendix B: “Environmental and electrical regulatory data” on page 277.

## Software requirements

The Succession Media Card emulates the Enhanced Extended Universal Trunk (EXUT) card. The Succession Media Card uses the existing Trunk Administration Overlay 14 and Trunk Route Administration Overlay 16 programs to configure the MIRAN III trunk parameters and MIRAN III trunk routes.

**Note:** MIRAN III functionality requires Release 19 or later, and Succession CSE Release 1 or later.

The software release and the available software options that the user has, affect the functions of the MIRAN III Succession Media Card. The following paragraphs detail the differences.

Meridian 1 and Succession CSE 1000 Options 11C, 11C Mini, 51C, 61C, and 81C support MIRAN III.

**Note:** For Option 11C, the Succession Media Card must be installed in the Main Cabinet for CE-MUX capabilities.

### **For users with Release 23 and Succession CSE 1000 Release 1 or later, and RAN Broadcast**

With the RAN Broadcast feature, each internal one-to-one channel can support up to 30 callers simultaneously using a single time slot. RAN Broadcast also provides other benefits, such as the ability to stagger announcements based on time or number of callers in queue, and the ability to provide MOH until a RAN is available.

**Option 11C and Option 11C Mini with RAN Broadcast**

The Option 11C systems come from the factory with 12 pre-installed RAN Broadcast connections. This allows 12 callers to hear the same RAN announcement on a single one-to-one channel. Additional RAN Broadcast connections for the Option 11C can be purchased.

**Succession CSE 1000 with Ran Broadcast**

Succession CSE 1000 does not come with pre-installed RAN Broadcast connections. The RAN Broadcast connections (NTM459AA) can be purchased in increments of four.

**Large Meridian 1 systems with RAN Broadcast**

Meridian 1 Options 51C, 61C, and 81C systems do not come with pre-installed RAN Broadcast connections. RAN Broadcast connections (SW150A) can be purchased in increments of one.

***Example:***

A customer with a large Meridian 1 system requires RAN for two incoming trunk routes. Each route requires a first RAN for up to 25 callers and a second RAN for up to 20 callers. The system then requires 90 RAN Broadcast connections and one small MIRAN III Succession Media Card.

Table 6 lists the card slots in which MIRAN can be installed.

**Table 6**  
**Card slots available for MIRAN installation in different modules**

Meridian 1 and Succession CSE 1000 modules	Suitable card slots
NT8D37BA/EC IPE modules, NT8D11BC/ED CE/PE modules	All available IPE card slots
NT8D37AA/DC IPE modules	Slots 0, 4, 8, and 12
NT8D11AC/DC CE/PE modules	Slot 0
NTAK11BD Cabinets	Slots 1 to 10 in Main Cabinet Slots 11 to 50 in Expansion Cabinet(s)
NTDK91BB Main Chassis	Slots 1 to 3 (not 4)
NDTK92BB Chassis Expander	Slots 7 to 10
NDTDU14AA Media Gateway	Slots 1 to 3 (not 4)
NTDU15AA Media Gateway Expansion	Slots 7 to 10

**For users with Release 22.08 or 21.41 and earlier**

*Note:* This section applies to customers who do not have the multi-channel start/stop control (MLSS) option.

The eight MIRAN one-to-one channels each support only one RAN listener for each RAN route.



## For users with Release 21.45 or 22.16 and later, but without RAN Broadcast

*Note:* This section applies to customers who have the MLSS option, but do not have RAN Broadcast.

With the MLSS RAN mode, the MIRAN III one-to-one channels can each have the same RAN announcement or music assignment, and the same MLSS RAN trunk route assignment. Therefore, multiple callers can hear the same RAN announcement, although listening on different MIRAN III one-to-one channels. One large MIRAN III Succession Media Card in MLSS mode supports up to eight callers listening to the same announcement.

*Note:* Nortel Networks recommends that port/channel 7 of the MIRAN III Succession Media Card be reserved exclusively for the Telephone User Interface (TUI). This configuration leaves a maximum of seven listeners hearing the same announcement on a single Succession Media Card.

For example, using one of these software releases, ten callers must be able to hear the same RAN announcement.

Use ten MIRAN III one-to-one ports/channels (two MIRAN III Succession Media Cards), placing all of them in the same MLSS RAN route and placing the same recording on all ten channels.

*Note:* The MLSS RAN mode allows playing of the same recording independently on multiple channels over the same RAN route.

## MIRAN III requirements

The MIRAN III Succession Media Card equipment can be engineered to meet specific site and application requirements. Select the number of ports/channels and the size of the memory required to support current and future requirements. The MIRAN III Succession Media Card is available in a basic form that provides a limited number of ports/channels, and minimum memory size. Basic MIRAN can be easily upgraded by building on the existing basic platform to increase the number of ports/channels and the memory size.

## MIRAN III Succession Media Card channel capacity options

The MIRAN III Succession Media Card comes in three port/channel capacity options. These options are listed in Table 7.

For each capacity option, port 7 can be configured as a DID port for telephone-based TUI OA&M access. In this case, port 7 of the large MIRAN III Succession Media Card option is not available for RAN or MOH applications. Alternatively, port 7 on a large MIRAN III Succession Media Card can be configured for RAN and MOH when not needed for telephone-based OA&M access.

**Table 7**  
**Succession Media Card capacity options**

Succession Media Card capacity option	No. of one-to-one ports/channels (North America)	No. of one-to-one ports/channels (International)
Small	Not applicable	2 (See Note 1)
Medium	4 (See Note 1)	4 (See Note 1)
Large	8	8
<b>Note 1:</b> Also includes port 7 for the Telephone User Interface (TUI).		
<b>Note 2:</b> MIRAN III does not support multi-cross connect ports.		

The small and medium MIRAN III Succession Media Card options continue to have all one-to-one ports/channels available for RAN and MOH, because port/channel 7, which is used for telephone-based OA&M access, does not count against the port capacity for these two options.

## MIRAN III Succession Media Card listener capacity options

The size of the MIRAN III Succession Media Card (small, medium, or large) affects the number of simultaneous calls that the MIRAN III Succession Media Card can support. The RAN Broadcast feature also affects the number of simultaneous calls that the MIRAN III Succession Media Card can support.

Without RAN Broadcast, each internal one-to-one port can support a single call at a time. With RAN Broadcast, each internal one-to-one port can support 30 simultaneous listeners.

Table 8 lists the total call-handling capacity for each MIRAN III Succession Media Card size, with and without RAN Broadcast.

**Table 8**  
**Succession Media Card call-handling capacities**

Succession Media Card size option	Call capacity without RAN Broadcast	Call capacity with RAN Broadcast
Small	2	30
Medium	4	120
Large	7 (8)	210 (240)
<b>Note:</b> If port 7 is configured for RAN, the figures in parentheses apply.		

## Supported RAN modes

The MIRAN III Succession Media Card supports the following RAN modes for the internal channels:

- Internal one-to-one ports/channels support continuous and Level Start (LVL) RAN and MOH modes.
- Internal one-to-one ports/channels support Multi-Level Start/Stop (MLSS or MLVL) RAN and MOH modes.

**Note:** MIRAN supports Automatic Wake Up. To configure this feature on MIRAN, refer to Automatic Wake Up in *Features and Services* (553-3001-306).

## Voice storage capacity

Expand the MIRAN III Succession Media Card storage capacity by installing PC Cards into the faceplate slot (A: drive).

Table 9 lists the memory size and the corresponding announcement recording time.

**Table 9**  
**Succession Media Card voice storage capacity expansion**

Memory allocation	Recording time
Base Succession Media Card (NT0966CA) memory	approximately 20 to 24 minutes
64 Mb PC Card Flash memory	128 minutes
Each additional 1 Mb of Flash memory	2 minutes
<b>Note:</b> The royalty-free music file ( <b>filename: music.mcf</b> ) occupies approximately 6 minutes of the available 20 to 24 minutes of recording time.	

## Power and ground requirements

The card slot backplane (ac or dc) provides power to the Succession Media Card.

*Note:* The power supplied at the backplane card slot exceeds the power requirement for each Succession Media Card. Therefore, there is no restriction on the number of Succession Media Cards.

Table 10 displays the Succession Media Card power requirements.

**Table 10**  
**Succession Media Card power requirements**

Configuration	+/-15V	5V	Total Power
Basic 8-port/channel	4.958 W	5.46 W	10.418 W

The power budget requirement for the Succession Media Card is within the allowable budget. The maximum IPE module per-slot power budget is 30 Watts, with an effective limitation of 20 Watts for thermal compensation.

Table 11 shows the maximum current available from each power supply rail.

**Table 11**  
**Backplane power available (for each card slot)**

Supply Rail	Available on backplane	With dc-dc converter	Succession Media Card
3.3 V	—	2400 mA	8 W
5 V	2000 mA	2000 mA	10 W
+/- 15 V	800 mA	366 mA	10 W

The processor contains three separate grounds: logic, analog, and frame. Logic ground connects to the processor ground. The codec has its own separate analog ground that connects to the logic ground at a single point.

Each Succession Media Card I/O port routed to the backplane has its own ground to simplify connections.

## External equipment requirements

The MIRAN III Succession Media Card can perform RAN applications without any external connections.

External devices must be connected to the MIRAN III Succession Media Card faceplate connector or MIRAN Audio-adaptor, to perform any of the following operations:

- text-based (or terminal-based) OA&M
- web-based OA&M
- connecting external music sources to the MIRAN III Succession Media Card
- recording RAN announcements or music

## Maintenance terminal requirements

A VT100 terminal, or a PC emulating a terminal, is used to:

- perform RAN and Succession Media Card administration
- perform maintenance and diagnostics on each Succession Media Card

A terminal can use:

- amenu system to perform administrative and maintenance functions
- commands that are entered on the command line

The terminal must be connected to the Succession Media Card RS-232 interface. The connection can be made:

- at the mini-DIN connector on the Succession Media Card faceplate using the NTAG81CA or NTAG81DA Maintenance Cable for occasional use
- at the Amphenol connector through a 9-pin D-Sub connector on the Audio-adaptor

Terminal interface must be set at 9600 baud, 8 data bits, 1 stop bit, and no parity. The flow control is not supported.

## Telephone for OA&M access

An Unrestricted (UNR) DTMF telephone must be used for the Telephone User Interface (TUI). To perform telephone-based OA&M, set port 7 to be a DID trunk in the Meridian 1 system. The DID trunk route makes Succession Media Card port 7 accessible through a route access code from any unrestricted DTMF telephone. To access a Succession Media Card, enter a valid user name and password. Small and medium size Succession Media Card options also use port 7 for telephone-based OA&M access.

## External analog sources

The MIRAN III Succession Media Card provides a facility to connect tape recorders or CD players to do the following:

- record to file
- record announcements from the MIRAN III Succession Media Card onto a tape for backup
- record backed-up announcements to another MIRAN III Succession Media Card

These external analog sources can be connected to the Audio Jack connection on the MIRAN Audio-Adapter using the NTAG81AA Audio Cable.

*Note:* With MIRAN III Succession Media Card, a standard 3.5 mm stereo audio jack can also be used to provide an external audio source.

## Succession Media Card hardware list

Table 12 lists specific MIRAN III Succession Media Card hardware components designed to support RAN and MOH applications in the Meridian 1 and Succession CSE 1000 system.

Table 12 does not list external equipment, such as terminals, telephones, and recorders, because they are (or can be) non-proprietary products.

**Table 12**  
**Succession Media Card hardware list**

Component	Comments	Description
NT0966CA Succession Media Card	Provided	An IPE card that provides RAN and MOH applications over the Meridian 1 and Succession CSE 1000 system.
NTA0870611 MIRAN Audio-adaptor	Provided	Converts the Amphenol connector to one Ethernet port (10BaseT), a local RS-232 maintenance connection, and a 9-pin DIN connector audio jack

**Table 12**  
**Succession Media Card hardware list (Continued)**

Component	Comments	Description
NTAG81BA Maintenance Extender Cable	Optional	A 5 m (16.4 ft) cable that extends the NTAG81CA, NTAG81GA, or the NTAG81DA cables when connecting a terminal to the Succession Media Card. It has one DB-9 male and one DB-9 female connector.
NTAG81CA Maintenance Cable	Optional	A 3 m (9.8 ft) cable that connects the terminal to the Succession Media Card 8-pin Mini-DIN maintenance port on the faceplate. It is terminated with an 8-pin Mini-DIN male connector and a DB-9 female connector.
16 Mb and 64 Mb Compact Flash	Optional	Use with PC Card adaptor. Used for backup and storage
PC Card Adaptor	Optional	PC Card to Compact Flash Memory Card Adaptor.

### Ethernet/LAN requirements

MIRAN III customers can use the following alternatives for LAN connectivity access.

Table 13 summarizes the recommended access permissions allowed by the firewall. All other paths not in the table should be denied.

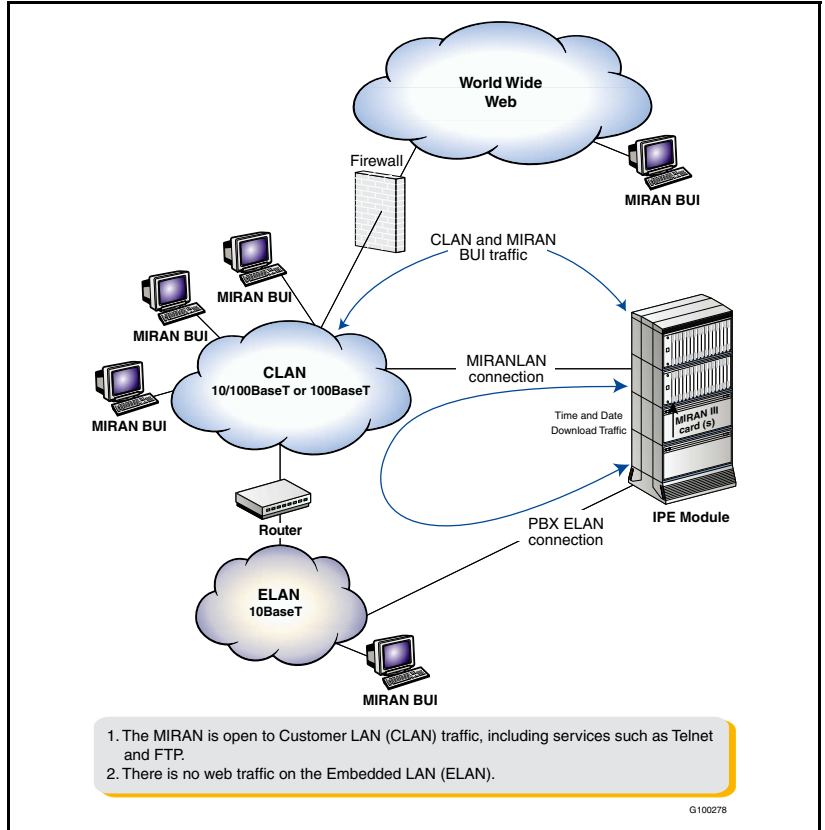
**Table 13**  
**Firewall access permissions**

Source	Destination	Protocol
WWW	MIRAN III	HTTP
C-LAN	MIRAN III	HTTP, FTP, TELNET



Figure 14 on page 97 and Figure 15 on page 98 show the network configuration options available for the MIRAN III.

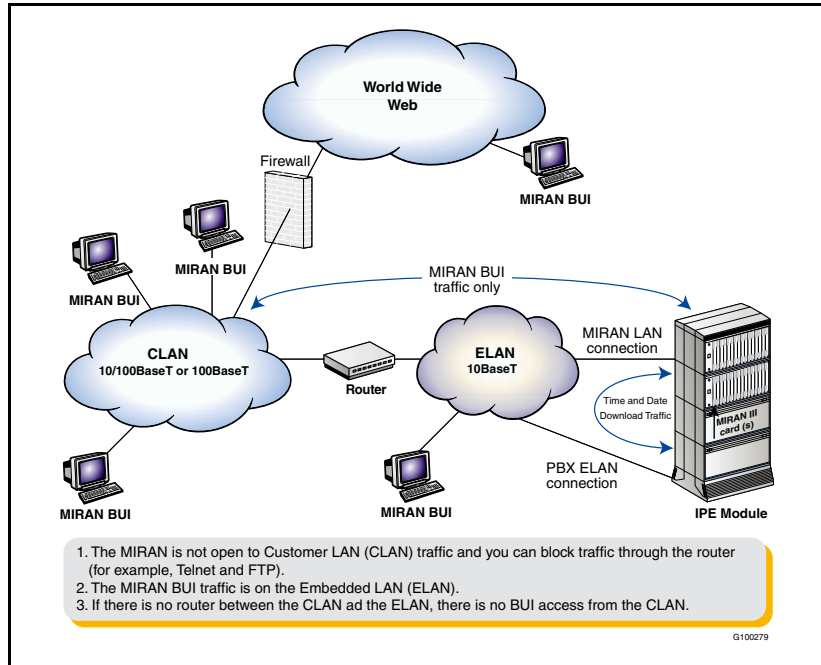
**Figure 14**  
**C-LAN connection**



The MIRAN network configuration option 1 has the following restrictions:

- The MIRAN III is open to C-LAN traffic and includes services such as telnet and ftp.
- There is no web traffic on the E-LAN.
- If there is no router available between C-LAN and E-LAN, manually program the Time of day on the MIRAN III Succession Media Card.

**Figure 15**  
**E-LAN Connection**



The MIRAN network configuration option 2 has the following restrictions:

- MIRAN III is not open to C-LAN traffic and the traffic can be blocked through a router, such as block telnet, and ftp.
- The MIRAN BUI traffic is available on the E-LAN.
- If there is no router between the C-LAN and the E-LAN, the BUI cannot be accessed from the C-LAN.

The following apply to LAN and intranet access only:

- Each site should select the most convenient option, taking into account the physical LAN endpoints available near the MIRAN card.
- When there are multiple MIRAN cards (that is, more than three) and the BUI is used frequently, the BUI traffic can load the E-LAN, so it may be better to connect the cards to the C-LAN.

## Summary of LAN installation information

To install and configure the LAN, follow the steps in Procedure 18.

### Procedure 18

#### Installing and configuring the LAN

- 1 Determine if MIRAN can be accessed from the World Wide Web. If yes, coordinate the firewall configuration with the user IS group according to Table 13 on page 96.
- 2 Determine what is the physical connection point of the MIRAN.  
**Note:** The 10BaseT is required for this procedure.
- 3 Get the following MIRAN IP parameters from the user IS group: IP address, gateway address, and subnet mask.
- 4 Get the Mail Server IP address from the user IS group. Confirm that MIRAN is allowed to access the server by SMTP.

————— *End of Procedure* —————

## Testing LAN configuration

To test the LAN configuration, follow the steps in Procedure 19.

### Procedure 19

#### Testing the LAN configuration

- 1 After MIRAN is installed and the IP parameters are configured, try to “ping” from any host in the C-LAN to MIRAN or from MIRAN to a host on the C-LAN.
- 2 In the case of World Wide Web access, try accessing MIRAN from a browser (HTTP access).

————— *End of Procedure* —————

Through the LAN connection, users can perform the following actions:

- Access a Browser User Interface (BUI) from any PC with a common web browser, in order to perform web-based OA&M (the BUI is embedded on the MIRAN III Succession Media Card).
- Perform FTP downloads and uploads of announcement and music files from the MIRAN III Succession Media Card.

- Telnet to the MIRAN III Succession Media Card text-based user interface through the BUI.

*Note:* Connection to the LAN is optional. All OA&M functions can be performed through the Text-based User Interface.

To access each MIRAN III Succession Media Card over the LAN, the following are required:

- one Audio-adaptor and Serial Cable (available as an accessory)
- a shielded RJ-45 mating coupler and shielded RJ-45 cable to connect to the customer hub (not supplied)
- an IP address, subnet mask, and Gateway for the card (supplied by the network administrator)
- an FTP client to transfer files remotely to and from the Succession Media Card. Nortel Networks recommends WS\_FTP.
- a telnet client for remote access to the Succession Media Card text-based User Interface. Nortel Networks recommends HyperTerminal 4.0 or later.
- a web browser that supports HTML frames. Nortel Networks recommends a minimum of Netscape Communicator 4.7 or Internet Explorer 4.0.

*Note:* European customers with an Option 51C-81C system that require LAN access to the MIRAN III must install the Succession Media Card (NT0966CA) in slot 0, 4, 8, or 12 in the IPE shelf.

### **LAN hub and router recommendations**

A 10/100BaseT switch is recommended.

## Engineering MIRAN III Succession Media Card and music application

Based on the options of the MIRAN III Succession Media Card equipment, external equipment, and the RAN and MOH requirements, a MIRAN III system can be engineered to meet the system requirements.

The following six examples illustrate the equipment that is required to meet specific site application requirements. It also discusses how to connect external devices to the MIRAN III Succession Media Card.

### Example 1:

Application requirements:

- Provide two internal RAN channels.
- Provide one hour of recording space on the MIRAN III Succession Media Card.
- Provide telephone-based OA&M access.

Equipment requirements:

- one small MIRAN III Succession Media Card
- one 64 Mb compact flash with PC Adaptor Card

### Example 2:

Application requirements:

- Provide multi-channel level start/stop control RAN mode for four internal RAN channels.
- Provide four minutes of recording space on the MIRAN III Succession Media Card.
- Provide terminal-based OA&M access.

Equipment requirements:

- one medium MIRAN III Succession Media Card

- one NTAG81CA Maintenance cable (8-pin mini DIN to 9-pin D-sub) to connect to the faceplate

**or**

- one NTAG81BA Maintenance cable extender (9-pin D-sub male to 9-pin D-sub female) to connect to the Audio-adaptor

*Note:* In this mode, all four ports/channels play the same announcement independently over the same RAN route.

### **Example 3:**

Application requirements:

- Provide seven internal RAN channels.
- Provide one hour of recording space on the MIRAN III Succession Media Card.
- Provide telephone-based OA&M access.
- Provide terminal-based OA&M access.
- Provide web-based OA&M access.

Equipment requirements:

- one large MIRAN III Succession Media Card
- one 64 Mb compact flash with PC Adaptor Card
- one NTAG81CA Maintenance cable (8-pin MINI DIN to 9-pin D-sub) to connect to the faceplate

**or**

- one NTAG81BA Maintenance cable extender (9-pin D-sub male to 9-pin D-sub female) to connect to the Audio-adaptor

### **Example 4:**

Application requirements:

- Provide 11 internal RAN channels.
- Provide one hour of recording space on the MIRAN III Succession Media Card.

- Provide telephone-based OA&M access.
- Provide terminal-based OA&M access.

Equipment requirements:

- one large MIRAN III Succession Media Card
- one 48 Mb compact flash memory card adaptor
- one medium MIRAN III Succession Media Card for the international market
- two NTAG81CA Maintenance cables (8-pin MINI DIN to 9-pin D-sub) to connect to the faceplate

**or**

- two NTAG81BA Maintenance cable extenders (9-pin D-sub male to 9-pin D-sub female) to connect to the Audio-adaptor

*Note:* The total number of internal one-to-one ports is 12. Configure port 7 on each card as a DID trunk for telephone-based OA&M access. This reduces the number of available ports for RAN and MOH applications on the large MIRAN III Succession Media Card to seven port, but the number of available ports on the small (or medium) MIRAN III Succession Media Card remains at four.

### **Example 5:**

Application requirements:

- Provide 14 internal RAN channels.
- Provide one hour of recording space.
- Provide two external analog (music) sources.
- Provide telephone-based OA&M access.
- Provide terminal-based OA&M access.

Equipment requirements:

- one 64 Mb compact flash with PC Adaptor Card
- two NTAG81AA Audio cables to connect external analog sources, or two standard stereo cables

- two NTAG81CA Maintenance cables (8-pin MINI DIN to 9-pin D-sub) to connect to the faceplate

**or**

- two NTAG81BA Maintenance cable extenders (9-pin D-sub male to 9-pin D-sub female) to connect to the Audio-adaptor

**Note:** The total number of internal one-to-one ports is 16. Configure port 7 on each card as a DID trunk for telephone-based OA&M access. This reduces the number of available ports for RAN and MOH applications on each large MIRAN III Succession Media Card to seven ports.

### **Example 6:**

Application requirements:

- Provide 3 recorded announcements for up to 12 total simultaneous callers and MOH for up to 64 simultaneous callers.
- Provide four minutes of recording space on the MIRAN III Succession Media Card.
- Provide telephone-based, terminal-based, and web-based OA&M access.

Equipment/system requirements:

- one medium MIRAN III Succession Media Card
- Release 23 or later system software with RAN and Music Broadcast features
- twelve RAN Broadcast connections
- sixty-four Music Broadcast connections

**Note:** Nortel Networks pre-equips each Option 11C with 12 RAN Broadcast connections and 100 Music Broadcast connections. For all other Meridian 1 options (Options 51C-81C), additional RAN and Music Broadcast connections can be purchased in increments of one.



- one NTAG81CA Maintenance Cable (8-pin MINI DIN to 9-pin D-sub) to connect to the faceplate
- or**
- one NTAG81BA maintenance cable extender (9-pin D-sub male to 9-pin D-sub female) to connect to the Audio-adaptor



---

# RAN Application: Browser User Interface

---

## Contents

This section contains information on the following topics:

- Accessing the BUI. . . . . 109
- Logging in to the BUI. . . . . 109
- Navigating the BUI. . . . . 111
  - MIRAN III Administration menu. . . . . 111
  - Pack (MIRAN III Succession Media Card) Administration menu. . . 123
  - Pack (MIRAN III Succession Media Card) Information. . . . . 134
  - File System. . . . . 137
  - Pack (MIRAN III Succession Media Card) User. . . . . 143
  - Support . . . . . 147
- Resetting the BUI. . . . . 151
- Logging out of the BUI. . . . . 151
- Help on the BUI. . . . . 151

## Introduction

This chapter describes the MIRAN Browser User Interface (BUI). The BUI applies to MIRAN III Succession Media Cards which are configured with a valid IP address and connected to a LAN through an Ethernet adaptor. The BUI can also be accessed using a cross-over cable that provides a direct connection to the card. For equipment and configuration information regarding the MIRAN III Succession Media Card BUI, refer to “LAN access installation and setup” on page 73.

*Note:* OA&M functions can also be performed through the Text-based User Interface and the Telephone User Interface (TUI). Refer to “RAN Application: Text-based User Interface” on page 153 and “RAN Application: Telephone User Interface” on page 239.

The MIRAN III BUI allows the user to access the Succession Media Card through the LAN using a common web browser. For a web browser, Nortel Networks recommends using Netscape Communicator 4.7 or later, or Internet Explorer 4.0 or later.

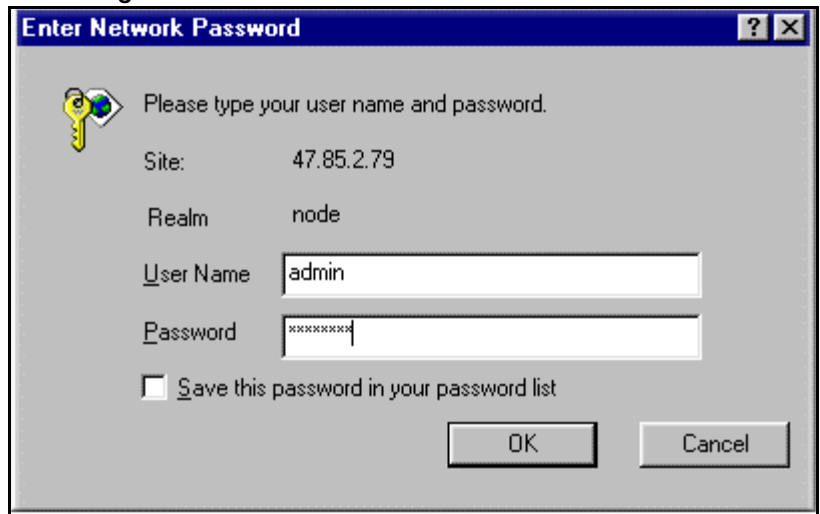
*Note:* Any web browser used must support HTML frames.

To access the Succession Media Card through a web browser, the IP address of the Succession Media Card must first be configured through the Text-based User Interface on the maintenance serial port. Request a different IP address for each Succession Media Card in the system.

## Accessing the BUI

To access the Succession Media Card through a web browser, enter the IP address of the card in the URL address field. The MIRAN Login screen appears. See Figure 16.

**Figure 16**  
**MIRAN Login screen**



The screenshot shows a Windows-style dialog box titled "Enter Network Password". It contains a key icon and the text "Please type your user name and password." Below this, it displays the site address "47.85.2.79" and the realm "node". There are two input fields: "User Name" with the text "admin" and "Password" with masked characters "xxxxxxx". At the bottom, there is a checkbox labeled "Save this password in your password list" which is unchecked. Two buttons, "OK" and "Cancel", are located at the bottom right of the dialog.

## Logging in to the BUI

*Note:* If there are no Users configured in MIRAN III, only an Administrator can log in. Once logged in, the Administrator can configure the new Users.

To log in to the MIRAN III BUI, follow the steps in Procedure 20.

**Procedure 20**  
**Logging into the MIRAN III BUI**

- 1 Enter a valid User Name in the User Name field.
- 2 Enter a valid password in the Password field.

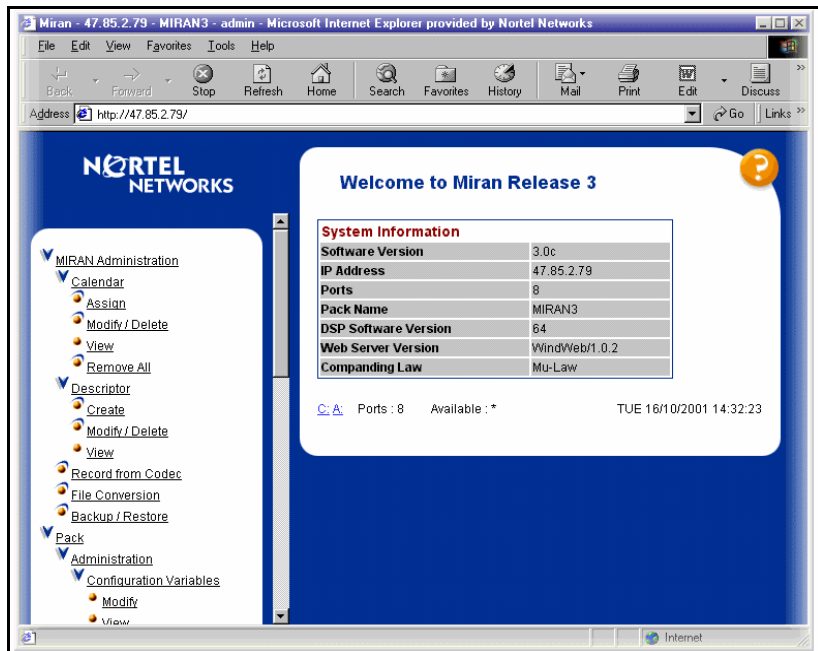
*Note:* For the initial login, default user names and passwords are the same as those for the Text-based User Interface. Refer to "Login screen" on page 158.

- 3 Click **OK**.  
If the login is successful, the “Welcome to MIRAN” screen appears.  
See Figure 17 on page 110.

**Note:** After three unsuccessful login attempts, the BUI locks the user out for 20 minutes.

————— *End of Procedure* —————

**Figure 17**  
**Welcome to MIRAN screen**



## Navigating the BUI

The Main BUI screen consists of two frames. The left frame provides links to the MIRAN OA&M functions to which the user has access.

The right frame of the Main BUI screen is where OA&M information is displayed and where all user input takes place. Access the OA&M menus and screens by clicking on the appropriate link either in the left frame or in the selected menu.

Drop-down list boxes of available options and text fields are provided in all context screens that require data entry. Select the required option with the mouse, or enter the required information in the text box, before pressing the Submit/Execute button for the form. When the operation is completed, a confirmation or an error message is displayed in a results table.

The Menu links in the left frame of the MIRAN III BUI consist of:

- “MIRAN III Administration menu” on page 111
- “Pack (MIRAN III Succession Media Card) Administration menu” on page 123
- “Pack (MIRAN III Succession Media Card) Information” on page 134
- “File System” on page 137
- “Pack (MIRAN III Succession Media Card) User” on page 143
- “Support” on page 147

At any time during the session, click on these links to access the menus.

The following sections describe menus and screens in the MIRAN III BUI.

### **MIRAN III Administration menu**

The MIRAN III Administration menu consists of links to the following:

- Calendar
- Descriptor
- Record from Codec
- File Conversion
- Backup/Restore

### Calendar operations

Use the Calendar screens for making calendar assignments to any of the available channels. For a description of the Calendar operation, refer to “Calendar assignment feature” on page 28.

### Assign

When the user clicks the **Assign** link, the Calendar Assignment screen appears. See Figure 18.

**Figure 18**  
**Calendar assignment screen**

**Calendar Assignment**

<b>Calendar Assignment</b>	
Filename	C:ANN00001.ULW
Date	
Time	
Descriptor	lunch
Channels	4

C: A: Ports : 8 MON 03/09/2001 13:59:50

Use the Calendar Assignment screen to add time- and date-based assignments to the 366-day calendar.



To add an entry to the calendar, follow the steps in Procedure 21.

**Procedure 21****Adding an entry to the calendar**

- 1 Select an announcement file from the Filename drop-down list. The Filename drop-down list contains all available announcement files and the codec option. Selecting codec assigns the input from the analog input on the Audio Adaptor.
- 2 Select a descriptor from the Descriptor drop-down list.  
The Descriptor drop-down list contains all calendar descriptors.  
**Note:** The descriptor that the user chooses from the Descriptor drop-down list overrides any values entered in the Time and Date fields.
- 3 To make an assignment with an explicit date and time:
  - a. Enter the date and time values in the Date and Time fields.
  - b. Select None from the Descriptor drop-down list.
- 4 In the Channels field, enter a string describing a channel or list of channels.  
Examples:
  - “0,3” for channels 0 and 3
  - “4-7” for channels 4, 5, 6, and 7
  - “0, 3-5,7” for 0, 3, 4, 5, and 7
  - “\*” (star symbol) for all channels to which the user has access**Note:** Error messages appear if users attempt to make assignments to channels to which they do not have access.
- 5 Click **Assign**.

---

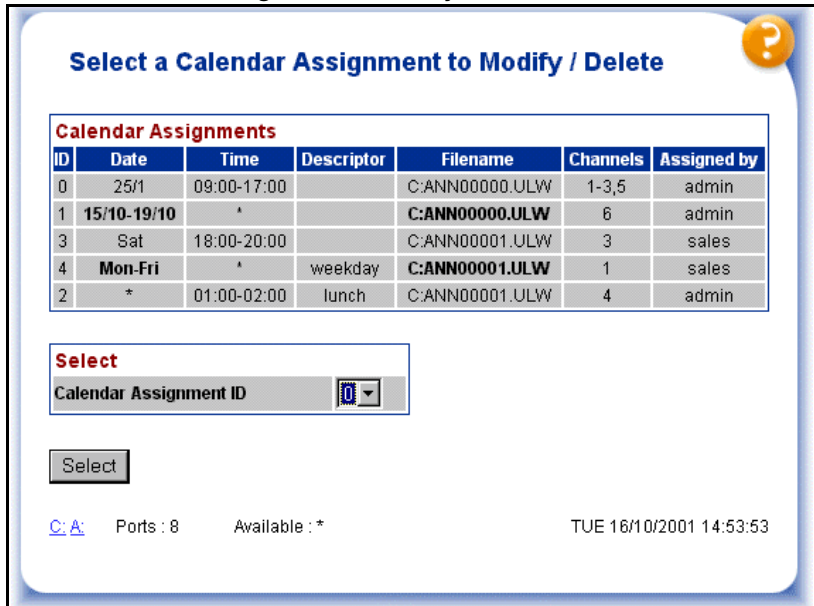
*End of Procedure*

---

**Modify/Delete**

When a user clicks the **Modify/Delete** link, the Select a Calendar Assignment to Modify/Delete screen appears. See Figure 19.

**Figure 19**  
**Select a Calendar Assignment to Modify/Delete screen**



To modify or delete a calendar assignment, follow the steps in Procedure 22.

**Procedure 22**  
**Modifying or deleting a calendar assignment**

- 1 Select a calendar assignment ID from the Calendar Assignment drop-down list.
- 2 Click **Select**. The Calendar Assignment’s information appears.
- 3 Modify the Calendar Assignment information or delete the Calendar Assignment.

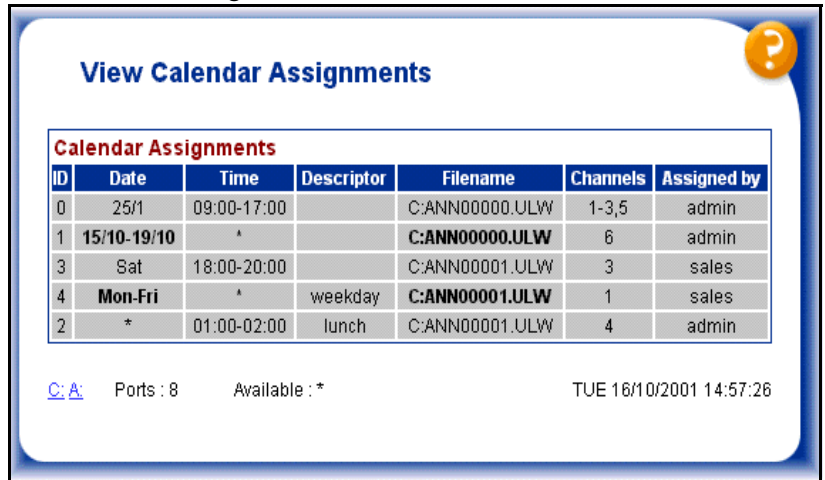
**Note:** Only the user who made the assignment can delete it. A user logged in as an administrator or above can remove any assignment.

————— *End of Procedure* —————

## View

When users click the **View** link, the View Calendar Assignments screen appears. See Figure 20.

**Figure 20**  
**View Calendar Assignments screen**



Calendar Assignments						
ID	Date	Time	Descriptor	Filename	Channels	Assigned by
0	25/1	09:00-17:00		C:ANN00000.ULW	1-3,5	admin
1	<b>15/10-19/10</b>	*		<b>C:ANN00000.ULW</b>	6	admin
3	Sat	18:00-20:00		C:ANN00001.ULW	3	sales
4	<b>Mon-Fri</b>	*	weekday	<b>C:ANN00001.ULW</b>	1	sales
2	*	01:00-02:00	lunch	C:ANN00001.ULW	4	admin

[C: A:](#) Ports: 8 Available: \* TUE 16/10/2001 14:57:26

The View Calendar Assignments screen shows all defined Calendar assignments, as well as which users made the assignments. Assignments in the Calendar that match the current date and time have their file name highlighted in bold.

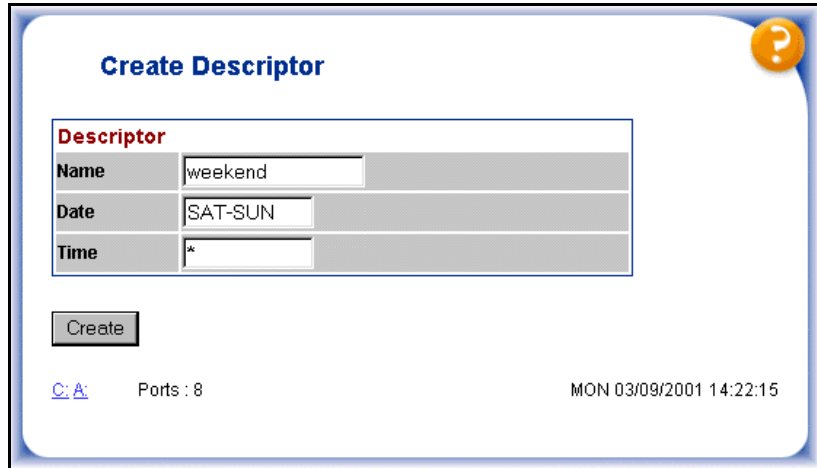
## Descriptor operations

Use the Calendar screens to add, modify, or delete calendar descriptors. Calendar descriptors are an easy way to store frequently used times and dates for assignments. Refer to “Calendar descriptors” on page 31.

### **Create**

When users click the **Create** link, the Create Descriptor screen appears. See Figure 21.

**Figure 21**  
**Create Descriptor**



**Create Descriptor**

**Descriptor**

<b>Name</b>	<input type="text" value="weekend"/>
<b>Date</b>	<input type="text" value="SAT-SUN"/>
<b>Time</b>	<input type="text" value="*"/>

[C: A](#) Ports : 8 MON 03/09/2001 14:22:15

To create a calendar descriptor, follow the steps in Procedure 23.

### **Procedure 23**

#### **Creating a calendar descriptor**

- 1 Enter the Descriptor name in the Name field.
- 2 Enter the Date that applies to the Descriptor in the Date field.
- 3 Enter the Time that applies to the descriptor in the Time field.
- 4 Click **Create**.

————— *End of Procedure* —————

## Modify/Delete

When users click the **Modify/Delete** link, the Select a Descriptor to Modify/Delete screen appears. See Figure 22.

**Figure 22**  
Select a Descriptor to Modify/Delete screen

**Select a Descriptor to Modify/Delete**

Descriptor	Date	Time	Creator
always	*	*	admin
christmas	25/12	*	sales
closed	*	17:00	admin
every_1st	1/*	*	support
every_friday	Fri	09:00-21:00	sales
january	1/1-31/1	*	sales
lunch	<b>Mon-Fri</b>	<b>13:*</b>	admin
morning	*	08:00-10:03	support
open_hours	<b>Mon-Fri</b>	<b>09:00-17:00</b>	admin
weekend	Sat-Sun	*	admin

**Select**

Descriptor:

Select

C: A    Ports : 8    WED 05/09/2001 13:44:18

To modify or delete a calendar descriptor, follow the steps in Procedure .  
Modifying or deleting a calendar descriptor

- 1 Select a calendar descriptor from the Descriptor drop-down list.
- 2 Click **Select**. The Descriptor information appears in the Modify/Delete screen. See Figure 23.

**Figure 23**  
**Select a Descriptor to Modify/Delete screen**

Descriptor	
Name	weekend
Date	Sat-Sun
Time	9:00-17:00

[C: A:](#) Ports : 8 MON 03/09/2001 14:23:40

- 3 Modify the calendar descriptor information, or delete the calendar descriptor.

**Note 1:** Only the user who created the descriptor can delete it. A user logged in as an administrator or above can remove any descriptor.

**Note 2:** If the calendar descriptor is modified, all calendar assignments using the descriptor are affected.

---

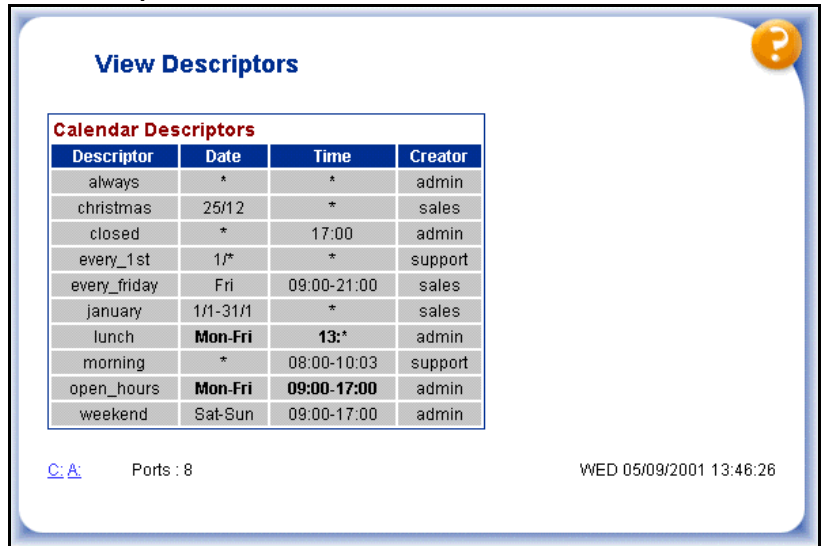
*End of Procedure*

---

## View

When users click the **View** link, the View Descriptors screen appears. See Figure 24.

**Figure 24**  
View Descriptors screen



Calendar Descriptors			
Descriptor	Date	Time	Creator
always	*	*	admin
christmas	25/12	*	sales
closed	*	17:00	admin
every_1st	1/*	*	support
every_friday	Fri	09:00-21:00	sales
january	1/1-31/1	*	sales
<b>lunch</b>	<b>Mon-Fri</b>	<b>13:*</b>	admin
morning	*	08:00-10:03	support
open_hours	<b>Mon-Fri</b>	<b>09:00-17:00</b>	admin
weekend	Sat-Sun	09:00-17:00	admin

C: A      Ports : 8      WED 05/09/2001 13:46:26

The View Descriptors screen shows the currently defined calendar descriptors. If the current time matches the time specified in any calendar descriptor entry, the Date and Time fields appear in bold.

### **Record from Codec**

When users click the **Record from Codec** link, the Record Announcement from Codec screen appears. See Figure 25.

**Figure 25**  
**Record Announcement from Codec screen**

**Record Announcement from Codec**

**Record**

Filename	C: ▾	TEST
Duration (Seconds)	50	

Record

Stop

C: A: Ports : 8 Available : \* TUE 12/02/2002 13:09:12

To record an announcement, follow the steps in Procedure 24.

#### **Procedure 24** **Recording an announcement**

- 1 Enter the file name of the announcement in the Filename field.  
**Note:** The file name cannot be longer than 12 characters.
- 2 Enter the record duration in seconds in the Duration field.  
**Note:** The record duration must be 5 to 120 seconds.
- 3 Click **Record**.

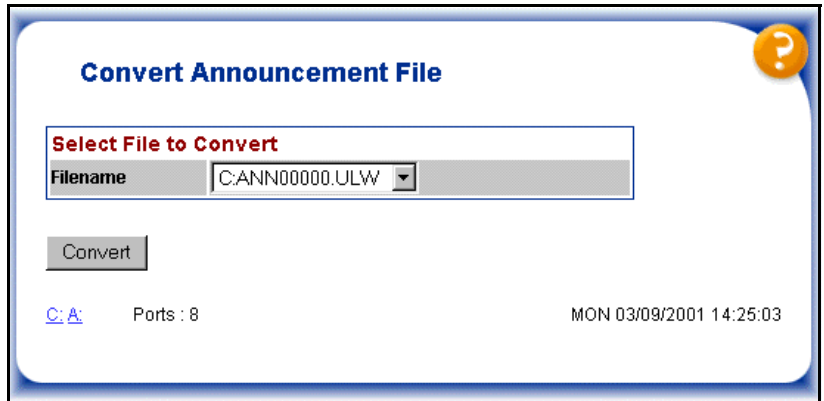
————— *End of Procedure* —————



### **File Conversion**

When users click the **File Conversion** link, the Convert Announcement File screen appears. See Figure 26.

**Figure 26**  
**Convert Announcement File screen**



The Convert Announcement File screen allows users to convert announcement files from .WAV to .ULW/.ALW format and from .ULW/.ALW to .WAV format.

To convert an announcement file, follow the steps in Procedure 25.

#### **Procedure 25** **Converting an announcement file**

- 1 Select the announcement file name from the Filename drop-down list.

**Note:** If users select a .ALW or .ULW file, it is converted to a .WAV file by adding the .WAV header. Users can then edit the .WAV file on their PC using an application, such as GoldWave.

If users select a .WAV file, it is converted to a .ULW or .ALW file, provided that the .WAV file is in an 8 Khz, Mono, A-Law, or Mu-Law format. If the file is not in one of these formats, it is rejected.

- 2 Click **Convert**.

————— *End of Procedure* —————

### **Backup and Restore**

When users click the **Backup/Restore** link, the Backup/Restore Configuration screen appears. See Figure 27.

**Figure 27**  
**Backup/Restore Configuration**



The Backup/Restore Configuration screen allows users to back up the calendar, the descriptors, and the configuration variables to the A: drive, or to restore the previously saved calendar, descriptors, and configuration variables from the A: drive. This is useful if the users want to have the same configuration on a number of Succession Media Cards.

*Note:* Only an Administrator, Distributor, or Super User can back up or restore variables.

To back up or restore, follow the steps in Procedure 26.

#### **Procedure 26** **Backing up or restoring**

- 1 Confirm that you want to back up or restore.
- 2 Click **Backup** or **Restore**.

————— *End of Procedure* —————

## Pack (MIRAN III Succession Media Card) Administration menu

The Pack Administration menu consists of links to the following:

- Configuration Variables
- Time and Date
- Ethernet Configuration
- Keycode Entry

### Configuration Variables

Configuration Variables are variables that control different aspects of MIRAN III operation. These variables are not immediately visible to the user.

*Note:* Usually default settings are sufficient; however, if non-standard options are required, an advanced user can view and change variables as required.

Table 14 lists the Configuration Variables available with MIRAN Release III.

**Table 14**  
**Configuration Variables**

Variable	Value	Description
DspEcanEnabled	True	Enables/disables Echo Cancellation.
DspReceiveGain	-18 to +6	Gain in Decibels into DTMF. Default to 0 dB. Can be used to adjust sensitivity of DTMF.
FileSortType	Name, type, size or time	Sort method for file display
Language of TUI Prompts	English	Language in which Telephone User Interface prompt appears.
PackName	MIRAN III	Name of pack (MIRAN III Succession Media Card) user assigned name of Succession Media Card.
SetBasedAccess	True/False	Telset User Interface access

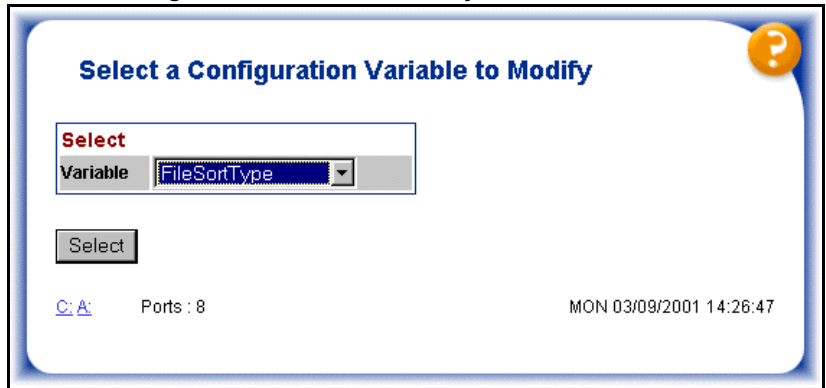
**Table 14**  
**Configuration Variables (Continued)**

Variable	Value	Description
StatsSaveFreq	1 to 7	Frequency in days at which to update Operational Statistics automatically
StatusUpdateFreq	0 to 60	Frequency in seconds at which to update status screen for CUI/BUI
SysDownloadFreq	1 to 7	Frequency in days at which to automatically download System Time and Date
SysDownloadTime	00:00 to 23:59	Time at which to automatically download System Time and Date
SysIPAddress	AA.BB.CC.DD	IP address of Meridian 1 and Succession CSE 1000 system. Used to download System Time and Date.
SysLoginEnabled	True/False	System Time and Date automatic download enabled/disabled
TuiSeizeAck	0 to 127	Trunk Seize Acknowledge code

**Select**

To modify a Configuration Variable, first select the variable. When users click the **Select** link, the Select a Configuration Variable to Modify screen appears. See Figure 28.

**Figure 28**  
**Select a Configuration Variable to Modify**

The screenshot shows a web browser window with a title bar. The main content area has a blue header with the text "Select a Configuration Variable to Modify" and a question mark icon in the top right corner. Below the header is a form with a "Select" label in red text. Underneath is a "Variable" label followed by a dropdown menu showing "FileSortType". Below the dropdown is a "Select" button. At the bottom left, there is a link "C: A:" and the text "Ports : 8". At the bottom right, the date and time "MON 03/09/2001 14:26:47" are displayed.

To select a Configuration Variable to modify, follow the steps in Procedure 27.

**Procedure 27**  
**Selecting a Configuration Variable to modify**

- 1 Select the Configuration Variable to be modified from the Variable drop-down list.
- 2 Click **Select**.

**Note:** Only an Administrator, Distributor, or Super User can modify the Configuration Variables.

————— *End of Procedure* —————

## **Modify**

When users click the **Modify** link, the Modify screen appears. See Figure 29.

**Figure 29**  
**Configuration Variables Modify screen**

<b>Modify</b>	
<b>Variable</b>	FileSortType
<b>Value</b>	<input type="text" value="Type"/>

[C: A:](#) Ports : 8 MON 03/09/2001 14:27:17

Use the Modify screen to customize some aspects of MIRAN III functionality by setting the values of the Configuration Variables. For each variable, there is an allowed set of values.

To modify a Configuration Variable, follow the steps in Procedure 28.

### **Procedure 28** **Modifying a Configuration Variable**

- 1 Enter the new value for the Configuration Variable in the Value text field.
- 2 Click **Modify**.

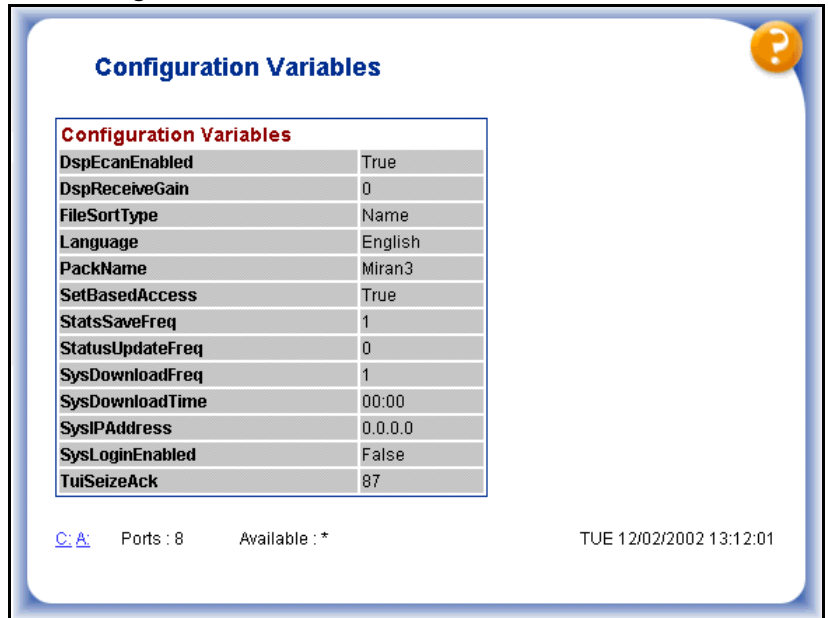
————— *End of Procedure* —————

When a Configuration Variable is modified, all variables are saved to C: \_CONFIG.DAT. Configuration Variables are automatically reloaded every time the card is rebooted.

## View

When users click the **View** link, a list of all Configuration Variables appears. See Figure 30.

**Figure 30**  
View Configuration Variables screen



## Time and Date

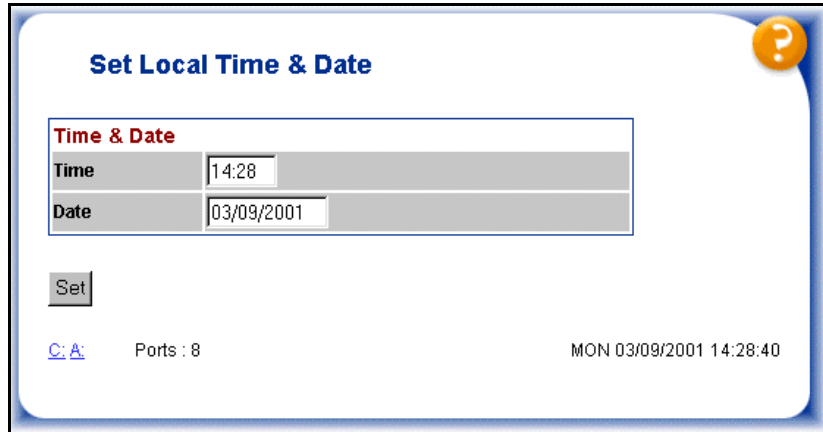
Under the **Time and Date** link, users can configure the local time and date and system synchronization.

*Note:* Only an Administrator, Distributor, or Super User can set or download the Time and Date.

### **Local Time and Date**

When users click the **Local Time and Date** link, the Set Local Time and Date screen appears. See Figure 31.

**Figure 31**  
**Set Local Time and Date screen**



Use the Set Local Time and Date screen to set the time on MIRAN's internal real-time clock.

To set the time and date, follow the steps in Procedure 29.

#### **Procedure 29** **Setting time and date**

- 1 Enter the current time and date in the Time and Date text fields respectively.
- 2 Click **Set**. The MIRAN internal clock automatically updates.

**Note:** The Calendar is affected, as all assignments are dependent on time and date.

————— *End of Procedure* —————

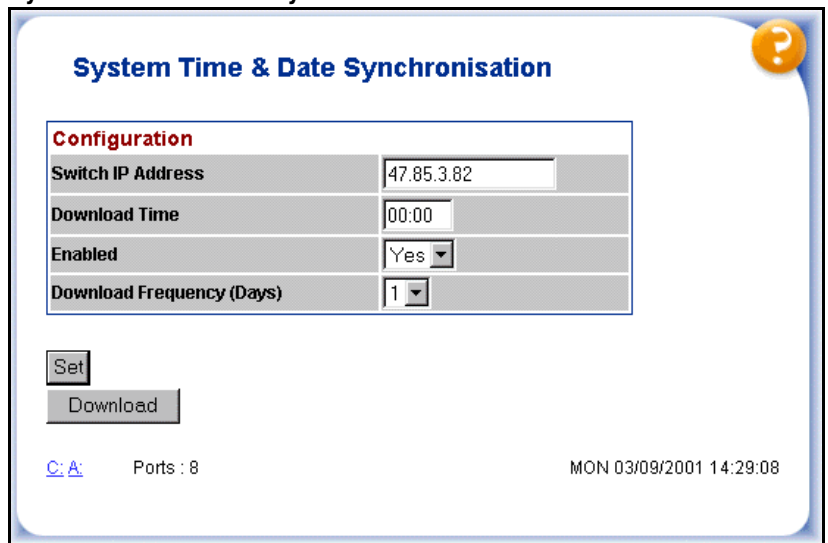


## Time and Date Download

When users click **Time and Date Download**, the System Time and Date Synchronization screen appears. See Figure 32. Use this screen to configure the system time and date synchronization.

With MIRAN III, the Succession Media Card retrieves the system time and date from the Meridian 1 and Succession CSE 1000 system on boot-up. The Succession Media Card logs in remotely and extracts the time and date. The session is then closed and the real-time clock is set accordingly.

**Figure 32**  
**System Time and Date Synchronization screen**



Configuration	
Switch IP Address	47.85.3.82
Download Time	00:00
Enabled	Yes
Download Frequency (Days)	1

Set

Download

C: A: Ports : 8

MON 03/09/2001 14:29:08



### CAUTION

Time and date synchronization can impact other system operations; therefore, Nortel Networks recommends that users plan the synchronization process carefully.

To configure the system time and date synchronization, follow the steps in Procedure 30.

**Procedure 30**  
**Configuring the system time and date synchronization**

- 1 Enter the IP address of the Meridian 1 and Succession CSE 1000 switch in the Switch IP Address text field.  
**Note:** The Switch IP Address is the address of the Meridian 1 and Succession CSE 1000 in which the Succession Media Card is installed. This IP address must be on the same subnet as the Succession Media Card.
- 2 In the Download Time text field, enter the time at which the Succession Media Card will attempt to synchronize with the Meridian 1 system.  
**Note:** The Succession Media Card makes three attempts to synchronize with the Meridian 1 and Succession CSE 1000 switch. If it is not successful, it will retry at the same download time once the number of days specified in the Frequency text field have elapsed.
- 3 Select Yes or No from the Enabled drop-down list.  
Set Enabled to Yes or No depending on whether or not the System Time and Date Synchronization is enabled.  
**Note:** If users select Yes from the Enabled drop-down list, the Succession Media Card automatically downloads the time and date from the Meridian 1 and Succession CSE 1000 system using the specified parameters and updates the internal real-time clock.
- 4 From the Download Frequency (Days) drop-down list, select the frequency of how often the Succession Media Card will attempt to synchronize with the Meridian 1 and Succession CSE 1000 switch.
- 5 Click **Set** or **Download**.

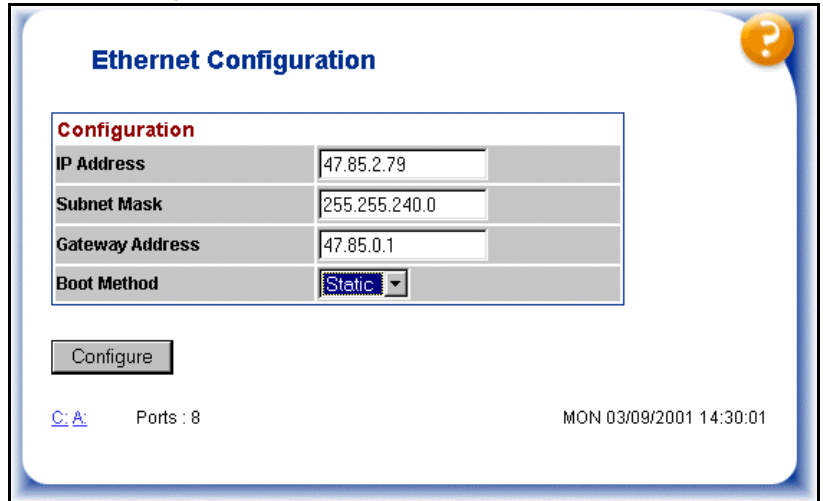
————— *End of Procedure* —————

## Ethernet Configuration

When users click the **Ethernet Configuration** link, the Ethernet Configuration screen appears. See Figure 33.

*Note:* Only Administrators, Distributors, or Super Users can configure the Ethernet.

**Figure 33**  
**Ethernet Configuration screen**



Configuration	
IP Address	47.85.2.79
Subnet Mask	255.255.240.0
Gateway Address	47.85.0.1
Boot Method	Static

Configure

[C: A:](#) Ports : 8 MON 03/09/2001 14:30:01



### CAUTION

Refer to your network administrator before setting the Ethernet parameters. Setting these parameters incorrectly can cause problems for other users in the network. In extreme cases, setting the Ethernet parameters incorrectly could lead to network outages.

To configure the Ethernet, follow the steps in Procedure 31.

**Procedure 31**  
**Configuring the Ethernet**

- 1 Enter the IP address and subnet mask in the appropriate text fields.
- 2 Enter the Gateway IP address in the Gateway Address text field. The Gateway IP address tells MIRAN where the local gateway router is located. It allows the Succession Media Card to be accessed from networks outside its own subnet.
- 3 Select the IP boot method from the Boot Method pull-down list. This boot method specifies how, from a networking perspective, the Succession Media Card will react on boot-up.

Select one of the following options from the Boot Method pull-down list:

- **Disabled:** The Succession Media Card will be inaccessible from the network
- **Static:** The static IP address which corresponds to the address on the screen. This is manually configured on the Text-based User Interface or BUI.
- **DCHP:** The Succession Media Card will request its IP address from the DCHP server on the network.

- 4 Click **Configure**.

————— *End of Procedure* —————

## Keycode Entry

When users click the **Keycode Entry** link, the Keycode Entry screen appears. See Figure 34.

*Note:* Only an Administrator, Distributor, or Super User can update a keycode.

**Figure 34**  
**Keycode Entry screen**

**Keycode Entry**

**Keycode Information**

Ports	8
Keycode	57657572 27322164 65334044

**Keycode**

Keycode	12345678 12345678 12345678
---------	----------------------------

[C: A:](#) Ports : 8 MON 03/09/2001 14:30:45

To enter a new keycode, follow the steps in Procedure 32.

### Procedure 32

#### Entering a new keycode

- 1 Enter the new keycode in the Keycode text field.
- 2 Click **Update**. The Keycode information is updated and any new ports are activated.

————— *End of Procedure* —————

## Pack (MIRAN III Succession Media Card) Information

The Pack Information menu consists of links to the following:

- Status
- System Information
- Operational Statistics

### Status

When users click on the **Status** link, the Pack Status screen appears. See Figure 35.

**Figure 35**  
Pack Status screen

### Pack Status

**Pack Information**

<b>Board Enabled</b>	Yes (Mu-Law)
<b>Time</b>	TUE 12/02/2002 13:14:00

**Port Status**

Unit	Enabled	Application	Assigned by	Message Source	Active
0	Yes	Start Stop	sales	C:ANN00000.ULW	No
1	Yes	Continuous RAN	sales	C:ANN00001.ULW	Yes
2	Yes	Continuous RAN	-	None	No
3	Yes	Continuous RAN	sales	C:ANN00001.ULW	Yes
4	Yes	Continuous RAN	support	C:ANN00001.ULW	Yes
5	Yes	Continuous RAN	support	C:ANN00002.ULW	Yes
6	Yes	Continuous RAN	admin	C:MUSIC.MCF	Yes
7	Yes	Set Based OA&M	-	?	No

**Codec Status**

Port	Function	Filename	Active
A0	Input	-	No

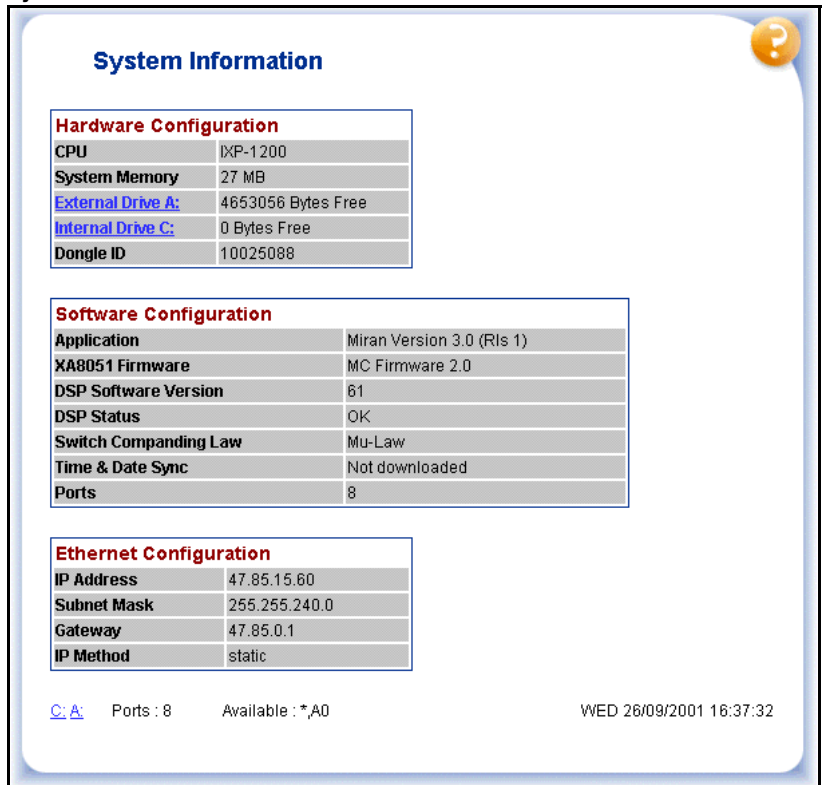
[C: A:](#) Ports : 8    Available : \*
TUE 12/02/2002 13:14:00

The Pack Status screen shows the configuration of all units on the Succession Media Card and whether or not they are active. The Pack Status screen also shows the status of the Codec input channel.

## System Information

When users click the **System Information** link, the System Information screen appears. See Figure 36.

**Figure 36**  
**System Information screen**



The screenshot displays the 'System Information' screen with a yellow question mark icon in the top right corner. It is organized into three main sections: Hardware Configuration, Software Configuration, and Ethernet Configuration. At the bottom, there is a status bar with network information and a timestamp.

### System Information

Hardware Configuration	
CPU	IXP-1200
System Memory	27 MB
<a href="#">External Drive A:</a>	4653056 Bytes Free
<a href="#">Internal Drive C:</a>	0 Bytes Free
Dongle ID	10025088

Software Configuration	
Application	Miran Version 3.0 (RIs 1)
XA8051 Firmware	MC Firmware 2.0
DSP Software Version	61
DSP Status	OK
Switch Companding Law	Mu-Law
Time & Date Sync	Not downloaded
Ports	8

Ethernet Configuration	
IP Address	47.85.15.60
Subnet Mask	255.255.240.0
Gateway	47.85.0.1
IP Method	static

[C: A:](#) Ports : 8 Available : \*,A0 WED 26/09/2001 16:37:32

The System Information screen shows the hardware, software, and Ethernet configuration information. To explore the drives shown in the Hardware Configuration section, click on the appropriate links.

### Operational Statistics

When users click the **Operational Statistics** link, the Operational Statistics screen appears. See Figure 37.

**Figure 37**  
**Operational Statistics screen**

**Operational Statistics**

**Pack Information**

Pack Alive Since	TUE 12/02/2002 12:18:00
Pack Alive For	0 Hours, 57 Minutes

**Operational Statistics**

Channel	Total	Last Hour	Average	Last Day	Average	Last Week	Average
0	7	0	0	0	2	0	0
1	19188	17	266	17	6390	17	0
2	16391	0	227	0	5463	0	0
3	50036	17	694	17	16673	17	0
4	18374	17	254	17	6119	17	0
5	73962	109	1025	109	24617	109	0
6	27921	3	387	3	9306	3	0
7	0	0	0	0	0	0	0

**Save**

Filename

C: A: Ports : 8 Available : \* TUE 12/02/2002 13:15:39

The Operational Statistics screen shows the operational statistics for all channels. In the Save section of the screen, users can save the statistics to file or reset them to zero.



## File System

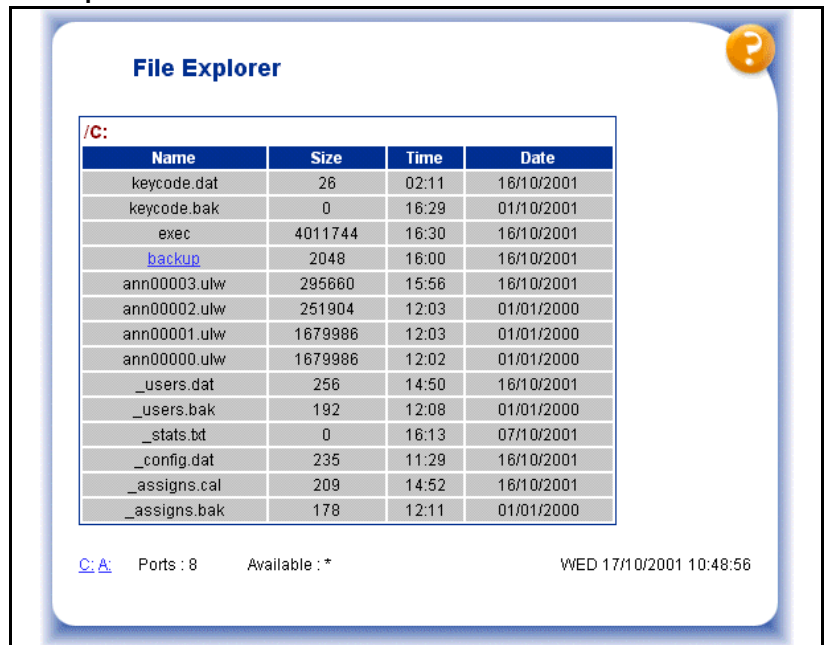
The File System menu consists of links to the following:

- File Explorer
- Copy
- Delete
- Move
- Rename
- Make Directory
- Remove Directory

### File Explorer

When users click the **File Explorer** link, the File Explorer screen appears. See Figure 38.

**Figure 38**  
**File Explorer screen**

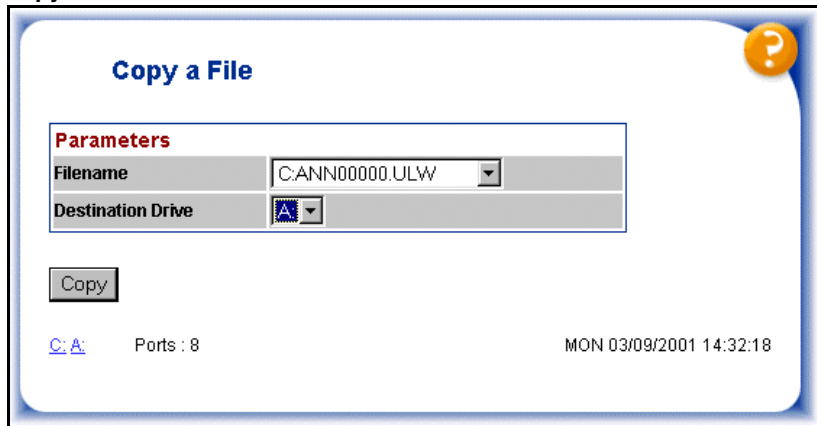


The File Explorer screen displays the file details for the specified drive. The directories appear as links. Click the links to display the contents of the directories.

### Copy

When users click the **Copy** link, the Copy a File screen appears. See Figure 39.

**Figure 39**  
**Copy a File screen**



To copy a file, follow the steps in Procedure 33.

### Procedure 33

#### Copying a file

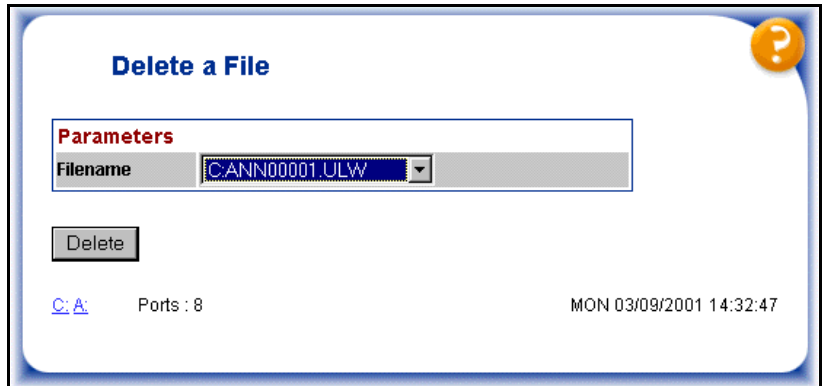
- 1 From the Filename drop-down list, select the file that you want to copy.
- 2 From the Destination Drive drop-down list, select the drive to which you want to the copy the file.
- 3 Click **Copy**.

————— *End of Procedure* —————

## Delete

When users click the **Delete** link, the Delete a File screen appears. See Figure 40.

**Figure 40**  
**Delete a File screen**



To delete a file, follow the steps in Procedure 34.

### **Procedure 34** **Deleting a file**

- 1 From the Filename drop-down list, select the file that you want to delete.
- 2 Click **Delete**.

**Note:** Users cannot delete a file that is assigned in the calendar.

————— *End of Procedure* —————

## Move

When users click the **Move** link, the Move a File screen appears. See Figure 41.

**Figure 41**  
**Move a File screen**

**Move a File**

**Parameters**

Filename C:ANN00002.ULW

Destination Drive A:

Move

[C: A:](#) Ports : 8

MON 03/09/2001 14:33:08

To move a file, follow the steps in Procedure 35.

### **Procedure 35** **Moving a file**

- 1 From the Filename drop-down list, select the file you want to move.
- 2 From the Destination Drive drop-down list, select the drive to which you want to move the file.
- 3 Click **Move**.

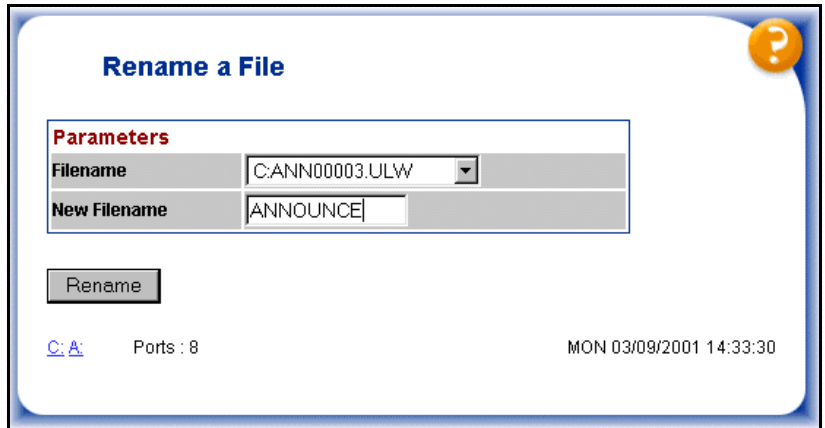
**Note:** Users cannot move a file currently assigned in the Calendar.

————— *End of Procedure* —————

## Rename

When users click the **Rename** link, the Rename a File screen appears. See Figure 42.

**Figure 42**  
**Rename a File screen**



**Rename a File**

**Parameters**

Filename	C:ANN0003.ULW
New Filename	ANNOUNCE

C: A: Ports : 8 MON 03/09/2001 14:33:30

To rename a file, follow the steps in Procedure 36.

### Procedure 36

#### Renaming a file

- 1 From the Filename drop-down list, select the file that you want to rename.
- 2 Enter the new file name in the New Filename text field.

**Note 1:** When renaming a file, users do not need to specify the drive.

**Note 2:** Users cannot rename a file assigned in the Calendar.

**Note 3:** Do not change the extensions of announcement (\*.ULW and \*.ALW) and Batch (\*.BAT) files.

- 3 Click **Rename**.

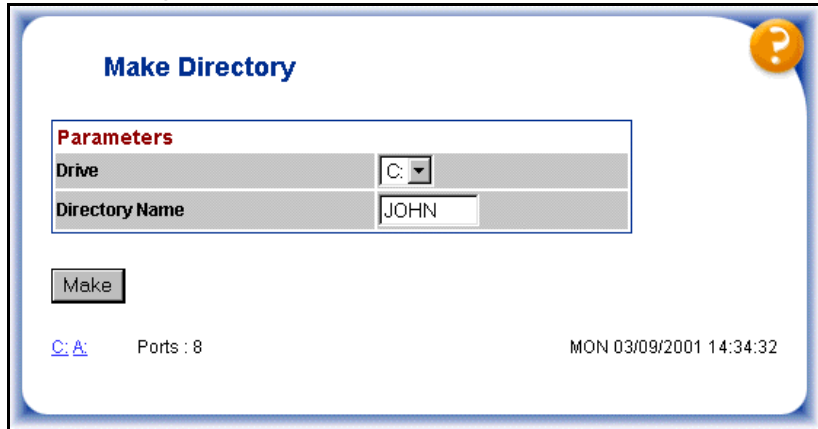
**Note:** Directory name cannot be greater than eight characters.

————— *End of Procedure* —————

## Make Directory

When users click the **Make Directory** link, the Make Directory screen appears. See Figure 43.

**Figure 43**  
**Make Directory screen**



**Make Directory**

**Parameters**

Drive	C: ▾
Directory Name	JOHN

[C: A:](#) Ports : 8 MON 03/09/2001 14:34:32

To make a directory, follow the steps in Procedure 37.

### **Procedure 37** **Making a directory**

- 1 From the Drive drop-down list, select the drive on which you want to create the directory.
- 2 In the Directory Name text field, enter the directory name.
- 3 Click **Make**.

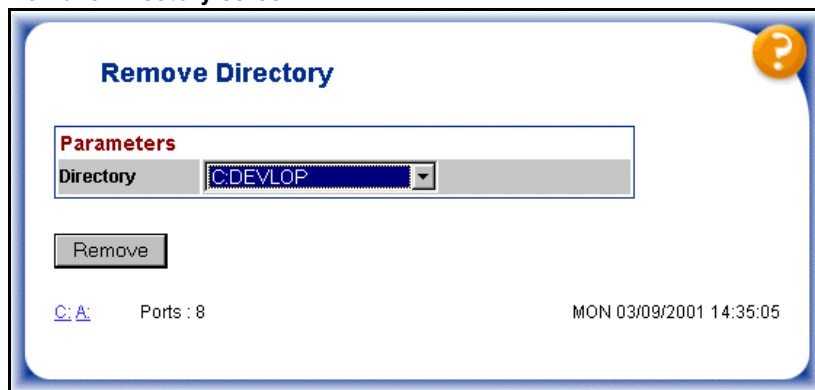
**Note:** Only Administrators, Distributors, or Super Users can make a directory.

————— *End of Procedure* —————

## Remove Directory

When users click the **Remove Directory** link, the Remove Directory screen appears. See Figure 44.

**Figure 44**  
**Remove Directory screen**



To remove a directory, follow the steps in Procedure 38.

### **Procedure 38** **Removing a directory**

- 1 Select the name of the directory from the Directory drop-down list.
- 2 Click **Remove**.

**Note:** Only Administrators, Distributors, and Super Users can remove a directory.

————— *End of Procedure* —————

## **Pack (MIRAN III Succession Media Card) User**

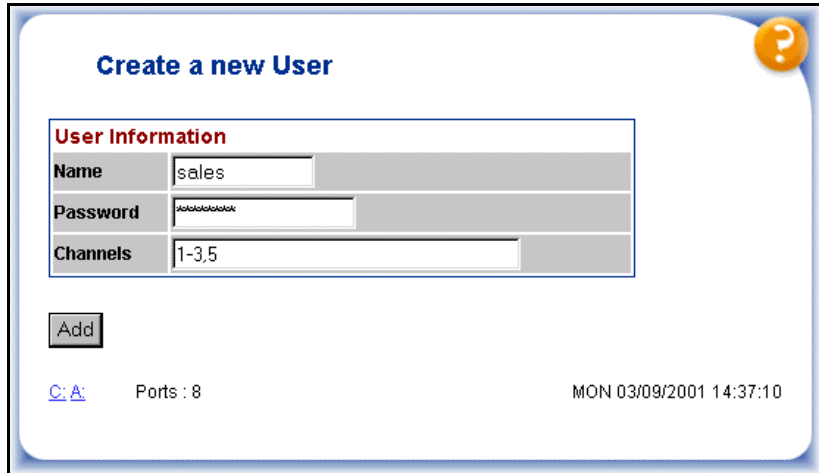
The Pack User menu contains links to the following:

- User Add
- User Select
- User Modify/Delete
- User View

## User Add

When users click the **User Add** link, the Create a new User screen appears. See Figure 45.

**Figure 45**  
**Create a new User screen**



**Create a new User**

**User Information**

Name	sales
Password	XXXXXXXXXX
Channels	1-3,5

C: A: Ports : 8 MON 03/09/2001 14:37:10

To add a new user, follow the steps in Procedure 39.

### Procedure 39 Adding a new user

- 1 Enter the User's name in the Name text field.
- 2 Enter the User's password in the Password text field.
- 3 Enter the channels to which the User has access.
- 4 Click **Add**.

**Note:** Only Administrators, Distributors, and Super Users can add Users.

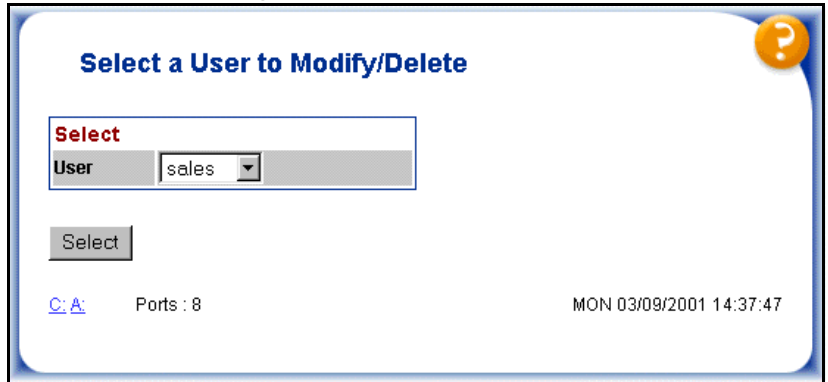
————— *End of Procedure* —————



## User Select

When users click the **User Select** link, the Select a User to Modify/Delete screen appears. See Figure 46.

**Figure 46**  
**Select a User to Modify/Delete screen**



**Select a User to Modify/Delete**

**Select**

User sales

Select

[C: A:](#) Ports : 8

MON 03/09/2001 14:37:47

To select a user to modify or delete, follow the steps in Procedure 40.

### **Procedure 40** **Selecting a user to modify or delete**

- 1 Select the user name from the User drop-down list.
- 2 Click **Select**. An updated User to Modify/Delete screen appears containing the User's information. See Figure 47 on page 146.

————— *End of Procedure* —————

**Figure 47**  
**Updated Select a User to Modify/Delete screen**

**Select a User to Modify/Delete**

**User Information**

<b>Name</b>	sales
<b>Password</b>	XXXXXXXXXX
<b>Channels</b>	3,5,A0

[C: A:](#) Parts : 8

MON 03/09/2001 14:38:06

To modify or delete a User, follow the steps in Procedure 41.

**Procedure 41**  
**Modifying or deleting a user**

- 1 Modify the User Name, Password, and Channels as required.
- 2 Click **Modify** to change the User's information.  
Click **Delete** to remove the User.

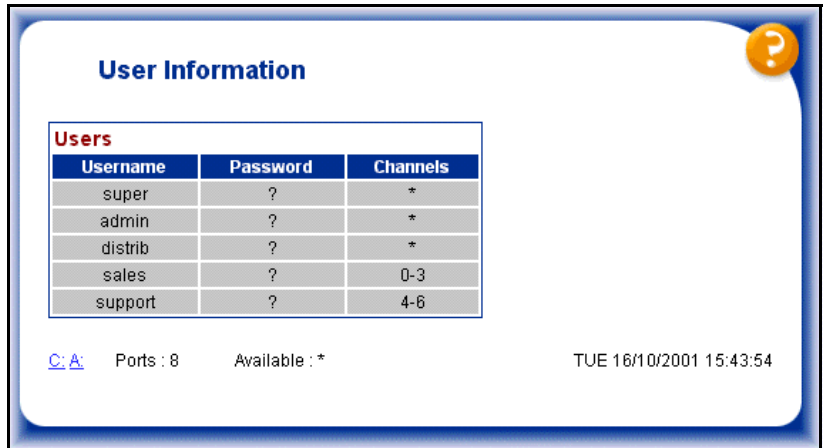
**Note:** Only Administrators, Distributors, and Super Users can modify or delete a User.

————— *End of Procedure* —————

## User View

When users click the **User View** link, the User Information screen appears. See Figure 48.

**Figure 48**  
**User Information screen**



Users		
Username	Password	Channels
super	?	*
admin	?	*
distrib	?	*
sales	?	0-3
support	?	4-6

C: A: Ports : 8 Available : \* TUE 16/10/2001 15:43:54

The User Information screen displays a list of all configured users.

**Note:** For security purposes, passwords are not displayed on this screen.

## Support

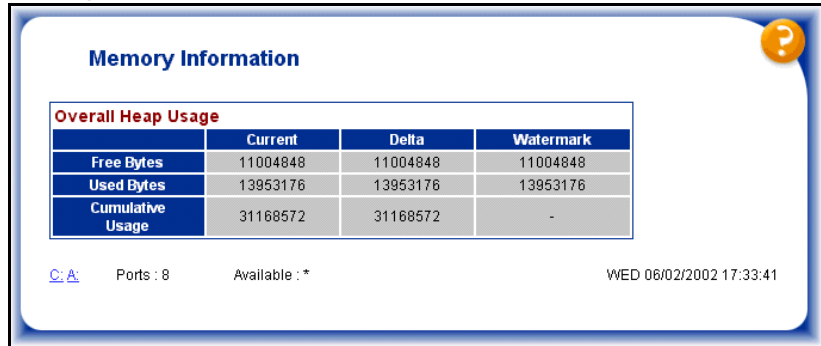
The Support menu contains links to the following:

- Memory Information
- Task Information
- DSP Information
- Reset
- Help
- Logout

## Memory Information

When users click the **Memory Information** link, memory information appears. See Figure 49.

**Figure 49**  
**Memory Information screen**

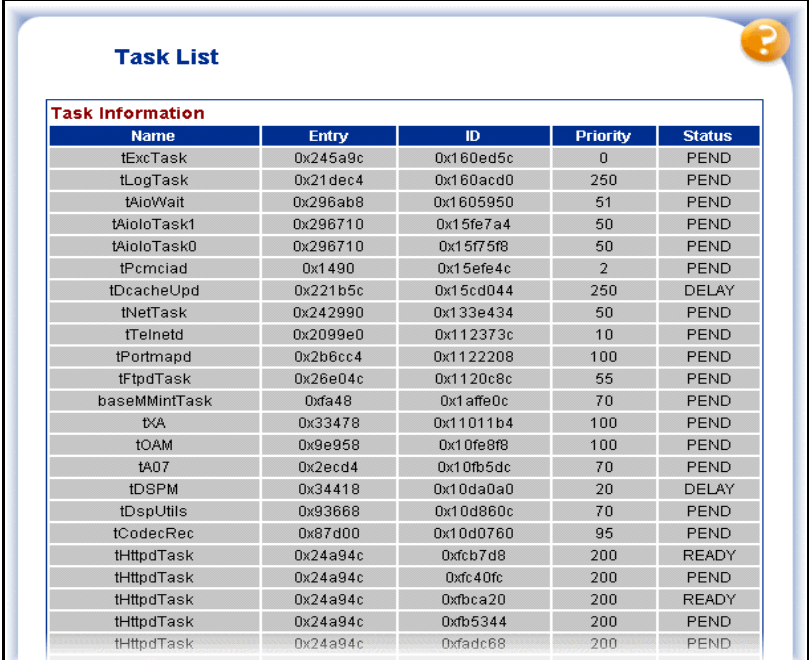


**Note:** Only Administrators, Distributors, or Super Users can view memory information.

### Task Information

When users click the **Task Information** link, the Task List appears. See Figure 50.

**Figure 50**  
**Task List screen**



The screenshot shows a web interface titled "Task List" with a question mark icon in the top right corner. Below the title is a table with the following data:

Task Information				
Name	Entry	ID	Priority	Status
tExcTask	0x245a9c	0x160ed5c	0	PEND
tLogTask	0x21dec4	0x160acd0	250	PEND
tAioWait	0x296ab8	0x1605950	51	PEND
tAioTask1	0x296710	0x15fe7a4	50	PEND
tAioTask0	0x296710	0x15f75f8	50	PEND
tPcmciad	0x1490	0x15efe4c	2	PEND
tDcacheUpd	0x221b5c	0x15cd044	250	DELAY
tNetTask	0x242990	0x133e434	50	PEND
tTeinetd	0x2099e0	0x112373c	10	PEND
tPortmapd	0x2b6cc4	0x1122208	100	PEND
tFtpdTask	0x26e04c	0x1120c8c	55	PEND
baseMMinTTask	0xfa48	0x1affe0c	70	PEND
tXA	0x33478	0x11011b4	100	PEND
tOAM	0x9e958	0x10fe8f8	100	PEND
tA07	0x2ecd4	0x10fb5dc	70	PEND
tDSPM	0x34418	0x10da0a0	20	DELAY
tDspUtils	0x93668	0x10d860c	70	PEND
tCodecRec	0x87d00	0x10d0760	95	PEND
tHttpdTask	0x24a94c	0xfcb7d8	200	READY
tHttpdTask	0x24a94c	0xfc40fc	200	PEND
tHttpdTask	0x24a94c	0xfbca20	200	READY
tHttpdTask	0x24a94c	0xfb5344	200	PEND
tHttpdTask	0x24a94c	0xfadc68	200	PEND

**Note:** Only Administrators, Distributors, or Super Users can view task information.

## DSP Information

When users click the **DSP Information** link, the DSP Information screen appears. See Figure 51.

**Figure 51**  
**DSP Information screen**

The screenshot shows a web interface titled "DSP Information" with a help icon in the top right corner. It contains two main sections:

**Timeslot Information**

Allocated	8 (0xff)
Timeslot 0	<a href="#">Core 0_Resource 0</a>
Timeslot 1	<a href="#">Core 0_Resource 1</a>
Timeslot 2	<a href="#">Core 0_Resource 2</a>
Timeslot 3	<a href="#">Core 0_Resource 3</a>
Timeslot 4	<a href="#">Core 0_Resource 4</a>
Timeslot 5	<a href="#">Core 0_Resource 5</a>
Timeslot 6	<a href="#">Core 0_Resource 6</a>
Timeslot 7	<a href="#">Core 0_Resource 7</a>

**DSP Core 0**

baseAddr	<a href="#">0x61000000</a>
appID	18
appMsgQ	0x1afc208
swVersion	0x64
nChansCreated	8
addrCommReg	<a href="#">0x61000200</a>
<a href="#">Resource 0</a>	Timeslot 0
<a href="#">Resource 1</a>	Timeslot 1
<a href="#">Resource 2</a>	Timeslot 2
<a href="#">Resource 3</a>	Timeslot 3
<a href="#">Resource 4</a>	Timeslot 4
<a href="#">Resource 5</a>	Timeslot 5
<a href="#">Resource 6</a>	Timeslot 6
<a href="#">Resource 7</a>	Timeslot 7

*Note:* Only Administrators, Distributors, or Super Users can view DSP information.

## Resetting the BUI

**Figure 52**  
**Resetting the BUI**



## Logging out of the BUI

**Figure 53**  
**Logging out of the BUI**



## Help on the BUI

For help on any BUI page, click on the orange “?” button on the top right of the context screen.





---

# RAN Application: Text-based User Interface

---

## Contents

This section contains information on the following topics:

General procedure for configuring MIRAN. ....	155
Configuring the VT-100 type terminal. ....	157
Login screen. ....	158
Status screen. ....	159
Main menu. ....	161
MIRAN Administration menu. ....	162
The Announcement Configuration menu. ....	163
Operational Statistics screen. ....	185
Backup Configuration screen. ....	186
Restore Configuration screen. ....	188
Run Batch File screen. ....	189
Pack Administration menu. ....	190
File Commands menu. ....	191
Keycode Entry screen. ....	199
Software Upgrade screen. ....	200
System Information screen. ....	202
Configuration Variables menu. ....	203
Ethernet Configuration screen. ....	206
Time & Date Configuration menu. ....	208
Maintenance and Diagnostics. ....	213
User Administration menu. ....	214
Add/Edit User screen. ....	215

View Users screen. ....	216
Delete User screen. ....	217
MIRAN III Succession Media Card OA&M command set. ....	218
OA&M Command summary. ....	219
OA&M Commands. ....	223
Announcement Commands. ....	225
Calendar commands. ....	226
Descriptor commands. ....	228
User commands. ....	229
File Commands. ....	230
Miscellaneous Commands. ....	233
MIRAN III batch file support. ....	235
Setting up emergency announcements quickly. ....	236

## Introduction

This chapter describes the Text-based User Interface for the MIRAN III Succession Media Card (NT0966CA) card. The Text-based User Interface provides menus and commands to perform all of the necessary MIRAN III OA&M functions. The software for this interface is part of the MIRAN III-specific OA&M tool running under VxWorks; it is independent of Meridian 1 software.

There are two ways to use the Text-based User Interface to access all commands and options:

- Use the menu system.
- Enter commands on the command line.

To use the MIRAN III Text-based User Interface, connect a VT-100 type terminal to the Succession Media Card. The Succession Media Card supports a serial connection between the terminal and the card.

The Succession Media Card also supports telnet access to the Text-based User Interface over a LAN. Refer to “Connecting a VT100-type terminal to the Succession Media Card” on page 69 for instructions on how to make a serial connection from the Succession Media Card to the VT-100 type terminal. Refer to “LAN access installation and setup” on page 73 for instructions on how to connect the Succession Media Card to the E-LAN.

MIRAN III also supports a Browser User Interface (BUI). This BUI provides a web-based version of the MIRAN III menu system, which can be accessed through a standard web browser. This BUI also supports file transfers and online viewing of customer documentation. For more information on the BUI, see “RAN Application: Browser User Interface” on page 107.

## General procedure for configuring MIRAN

To configure MIRAN functions, follow the steps in Procedure 42.

### Procedure 42 Configuring MIRAN

- 1** Configure the RAN and MOH trunk route and trunk data block, as “System configuration” on page 53 describes.  
  
Complete this step during installation and configuration.
- 2** Configure the DID trunk for the Telephone User Interface (TUI) access, if necessary. Refer to “Configuring the DID route for the TUI” on page 60 and “Configuring the MIRAN trunks” on page 61.  
  
Complete this step during installation and configuration.
- 3** Set up the terminal for the Text-based User Interface access, which “Connecting a VT100-type terminal to the Succession Media Card” on page 69 describes.  
  
Complete this step during installation and configuration.
- 4** Login to the MIRAN III Text-based User Interface as either a user or an administrator. Both a user name and a password must be entered.  
  
The default user login is *User Name: user* and *Password: user0000*.  
The default administrator login is *User Name: admin* and *Password: admin000*.  
The default distributor login is *User Name: distrib* and *Password: distrib0*.  
  
Refer to “Login screen” on page 158 for more detail.

- 5 Enter the keycode, if necessary. See “Keycode Entry screen” on page 199.  
**Note:** When MIRAN III is ordered as part of a new Meridian 1 (Options 51C through 81C), the factory pre-loads the keycode into MIRAN. Option 11C and stand-alone orders of the MIRAN require that the keycode be entered.
- 6 Perform a cold reboot of the Succession Media Card and log in again.  
  
Refer to “Maintenance and Diagnostics” on page 213 for instructions on performing a cold reboot.
- 7 Record the announcements. From the Main Menu, select the MIRAN Administration menu, followed by the Announcement Configuration menu, and then the Record Announcement screen.  
  
Refer to “Record Announcement from External Channel screen” on page 182. From this screen, record announcements through the Audio jack on the Audio-adaptor. The Audio jack provides access to a single analog input (ANALOG0).
- 8 Assign announcements. From the Record Announcement screen, return to the Announcement Configuration menu and select Calendar Operations. From the Calendar Operations menu, create assignments, with or without descriptors. Repeat this step for other files and channels.  
  
Refer to “Calendar Operations menu” on page 165.
- 9 Back up the original configuration onto the C: drive, or to a PC Card in the A: drive, if available.
- 10 Copy new files (if first installing or upgrading software) from the A: drive to the C: drive. Remove the PC Card from the A: drive and store in a safe place for future use. This enables the configuration to be restored into the MIRAN III Succession Media Card without having to re-configure the system and re-record the announcements.

---

*End of Procedure*

---

## Configuring the VT-100 type terminal

The Succession Media Card faceplate and the Succession Media Card Audio-adaptor each contains a Maintenance Serial port, which enables direct connection to a VT-100 terminal, or to a PC running a terminal emulation program.

*Note:* Alternatively, each Succession Media Card can be connected through an Ethernet adaptor to the LAN. This alternative enables maintenance of all Succession Media Cards from any PC that has web or telnet access.

To run the Text-based User Interface, configure the VT-100 terminal emulation parameters as shown in Table 15.

**Table 15**  
**VT-100 terminal configuration parameters**

Parameter	Setting
Transmission rate	9600 baud
Data bits; stop bit	8
Stop bit	1
Parity	No
Flow control	None

*Note:* MIRAN III uses the HyperTerminal application. This application allows the technician to disable the CTRL and arrow keys, as these keys are used by the OA&M for navigating the menus.

## Login screen

Figure 54 shows the MIRAN III Login screen. This screen appears when the terminal is connected to the MIRAN III Succession Media Card, and the Enter key is pressed.

**Figure 54**  
**Login screen**

```

[10025088]          - Log On -
[Miran3]

  ###  ###  ##  000000  000  000  00  ]]] ] [ [ [ [ [
##  ##  ##  ##  00  00  00  00  0000 00  ]] ] [ [ [
##  ##  ##  ##  00  00  00  00  00 00 00  ]] ] [ [ [
##  #   ##  ##  0000000 0000000 00 0000  ]] ] [ [ [
##  ##  ##  ##  00  00  00  00  00 00 00  ]] ] [ [ [
##  ##  ##  ##  00  00  00  00  00 00 00  ]]] ] [ [ [ [

  Meridian Integrated RAN Application
  Version 3.0h (Rls 1)
  Copyright (c) Nortel Networks. 2001

Username : -> _      <-
Password :

          - Log On -

          - Status -

  Keycode Validated
  
```

To log into the selected MIRAN III Succession Media Card, follow the steps in Procedure 43.

**Procedure 43**  
**Logging in to the selected MIRAN III Succession Media Card**

- 1 Enter the user name.
- 2 Enter the password.
- 3 Select the Login button.

————— *End of Procedure* —————

The defaults for user login are:

- **User Name:** user
- **Password:** user0000

The defaults for administrator login are:

- **User Name:** admin
- **Password:** admin000

The defaults for distributor login are:

- **User Name:** distrib
- **Password:** distrib0

*Note 1:* If an ‘Access denied’ response is received, press the ‘Shift’ key and tilde (~) to refresh the screen. Then attempt to log in again. If an ‘Access denied’ response is received for a third time, the Succession Media Card locks the user out for 20 minutes.

*Note 2:* All passwords must be at least eight characters in length, with a maximum of 12 characters. It is possible to change the passwords at each user level.

*Note 3:* All default users and passwords can be restored by deleting the C:\\_USERS.DAT file.

## **Status screen**

Select the Status button, without logging in to view the status of the current card.

Figure 55 on page 160 shows the Status screen, which displays:

- current status of the RAN Application version and release
- board status
- current time
- status of eight one-to-one channels and two cross-connect channels

To display up-to-date channels status, refresh the screen by pressing the spacebar.

To exit the Status screen and return to the Login screen, press the Enter key. See Figure 55 to view the Status screen.

**Figure 55**  
**Status screen**

```
[10025088]          - Pack Status -
[TUE 12/02/2002 11:48:20]
                    Board Enabled : Yes (Mu-Law)

Channel  Enabled  Application      Assigned by  Message Source  Active
-----  -
0         Y        Start/Stop RAN          None          None            N
1         Y        Start/Stop RAN          admin         C:GEORGE.ALW   N
2         Y        Start/Stop RAN          admin         C:GEORGE.ALW   N
3         Y        Start/Stop RAN          admin         C:GEORGE.ALW   N
4         Y        Start/Stop RAN          None          None            N
5         Y        Start/Stop RAN          None          None            N
6         Y        Start/Stop RAN          None          None            N
7         Y        Set Based OA&M          None          None            N

                    Cross Connect Ports

Port  Function  Application      Level          Message Source  Active
----  -
A0   Output   Idle             00 ( 00.0 dB)  None            N
A0   Input    Idle             None           None            N

                    Press Enter to exit, Space to refresh.
```



## Main menu

A successful login displays the Main menu. See Figure 56.

**Figure 56**  
**Main menu**

```
[10025088]          - Main Menu -          [Admin]

 1. MIRAN Administration...
 2. Pack Administration...
 3. Maintenance & Diagnostics...
 4. User Administration...

 9. Log Off...

Choose a Menu Option or 9 to Exit :
Miran3>_
```

The Main menu provides five options:

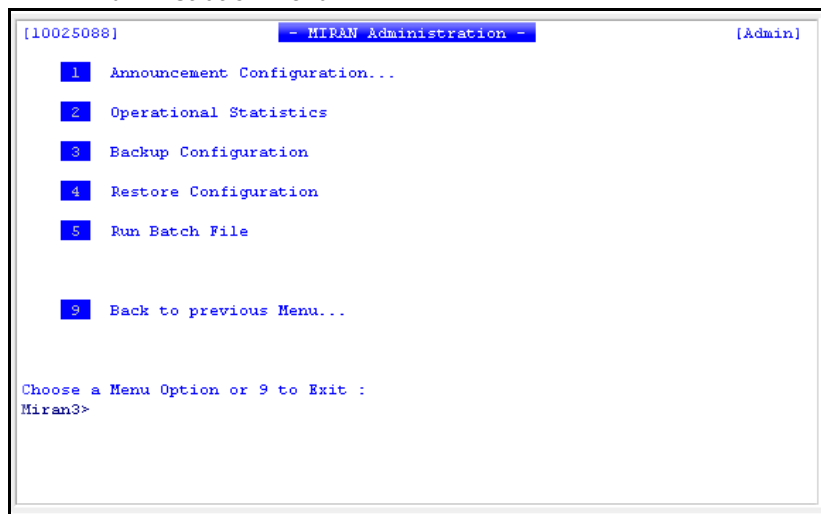
- **MIRAN Administration** – accesses all RAN-specific tasks and menus, such as announcement recording and configuration, operational statistics, backup and restore configuration, playback level setting, and batch file running.  
Refer to “MIRAN Administration menu” on page 162.
- **Pack Administration** – accesses all MIRAN III-specific tasks and menus, such as file commands, keycode entry, software upgrade, system information, configuration variables, and LAN configuration.  
Refer to “Pack Administration menu” on page 190.
- **Maintenance and Diagnostics** – provides access to system information, password change, command line access, diagnostics, warm reboot, and cold reboot. The distributor can access all functions, and the user can access only system information and password change.  
Refer to “Maintenance and Diagnostics” on page 213.

- **User Administration** – provides access to adding, editing, viewing, and deleting users.  
Refer to “User Administration menu” on page 214.
- **Logoff** – logs out of the Main Menu and returns to the Login screen.

## MIRAN Administration menu

At the Main menu, select **-1-** to access the MIRAN Administration menu. See Figure 57.

**Figure 57**  
**MIRAN Administration menu**



```
[10025088]          - MIRAN Administration -          [Admin]

 1 Announcement Configuration...
 2 Operational Statistics
 3 Backup Configuration
 4 Restore Configuration
 5 Run Batch File

 9 Back to previous Menu...

Choose a Menu Option or 9 to Exit :
Miran3>
```

At the MIRAN Administration menu, there are seven options:

- **Announcement Configuration...** – displays the Announcement Configuration menu that enables the following actions:
  - create calendar and descriptor announcements,
  - record and play announcements
  - convert announcement files.Refer to “The Announcement Configuration menu” on page 163.

- **Operational Statistics** – displays RAN channel usage statistics. Refer to the “Operational Statistics screen” on page 185.
- **Backup Configuration** – saves configuration to a PC disk. Refer to the “Backup Configuration screen” on page 186. Backups can also be set to occur automatically by setting the appropriate configuration variables.
- **Restore Configuration** – restores the configuration from a PC disk to the MIRAN. Refer to the “Restore Configuration screen” on page 188.
- **Run Batch File** – executes a batch file containing OA&M commands. It enables multiple channel assignments with a single command in case of emergency. Refer to the “Run Batch File screen” on page 189.
- **Back to previous Menu...** – returns to the Main menu.

## The Announcement Configuration menu

From the MIRAN Administration menu, select **-1-** to access the Announcement Configuration menu. See Figure 58.

**Figure 58**  
**Announcement Configuration menu**

```
[10025088]          - Announcement Configuration -          [Admin]
1  Calendar Operations...
2  Descriptor Operations...
3  Record Announcement from External Channel
4  Convert Announcement File
9  Back to previous Menu...

Choose a Menu Option or 9 to Exit :
Miran3>
```

At the Announcement Configuration menu, there are six options:

- **Calendar Operations** – used to create calendar assignments with or without descriptors, view calendar assignments, and remove calendar assignments. Refer to the “Calendar Operations menu” on page 165.
- **Descriptor Operations** – used to add, edit, view, and delete calendar descriptors. Refer to the “The Descriptor Operations menu” on page 175.

*Note:* Before working with Calendar Operations and Descriptor Operations, read the section, “Calendar assignment feature” on page 28.

- **Record Announcement from External Channel** – used to record an announcement and determine its filename and duration. Refer to the “Record Announcement from External Channel screen” on page 182.
- **Convert Message File** – used to convert an announcement from .WAV format to .ALW or .ULW format (or the opposite). The filename of the announcement can be changed here. Refer to the “Convert Announcement File screen” on page 183.
- **Back to previous Menu...** – returns to the MIRAN Administration menu.

## Calendar Operations menu

At the Announcement Configuration menu, select **-1-** to access the Calendar Operations menu. See Figure 59.

**Figure 59**  
**Calendar Operations Menu**

```
[10025088]          - Calendar Operations -          [Admin]
  1  Calendar Assignment with Descriptor
  2  Calendar Assignment
  3  View Calendar Assignments
  4  Delete Calendar Assignment
  5  Load Calendar List
  6  Save Calendar List
  7  Clear all Calendar Assignments
  9  Back to previous Menu...
Choose a Menu Option or 9 to Exit :
Miran3>
```

### **Calendar Assignment with Descriptor screen**

Select **-1-** at the Calendar Operations menu to access the Calendar Assignment with Descriptor screen. See Figure 60.

An announcement is assigned to selected channels and associated with a defined descriptor. Refer to “The Descriptor Operations menu” on page 175 for instructions on how to create a descriptor.

**Figure 60**  
**Calendar Assignment with Descriptor screen**

```
[10025088]      - Calendar Assignment with Descriptor -      [Admin]

Channels : 1-3
             - Browse Channels -
Filename : C:GEORGE.ALW
             - Browse -
Descriptor : weekday
             -> - Browse Descriptors - <-
             - Add to Calendar -
             - Exit -
```

To create a calendar assignment with a descriptor, follow the steps in Procedure 44.

#### **Procedure 44**

##### **Creating a calendar assignment with a descriptor**

- 1 Enter the channel(s) where the announcement will be assigned. Select **Browse** to scan and select from the list of available channels. Use ‘s’ to toggle the selection of channels.
- 2 Enter the filename of the announcement for which the assignment is being created. Select **Browse** to scan the list of available announcement files.
- 3 Enter the name of the descriptor to be associated with the assignment. Select **Browse Descriptors** to scan the list of available descriptors.

- 4 Select **Add to Calendar** to add the assignment with descriptor to the calendar. This updates the calendar immediately.
- 5 Select **Exit** to return to the Calendar Operations menu.

————— *End of Procedure* —————

### **The Calendar Assignment screen**

Select **-2-** at the Calendar Operations menu to access the Calendar Assignment screen. See Figure 61. An announcement is assigned to selected channels and defined directly (instead of using a descriptor) when the announcement plays on those channels.

**Figure 61**  
**Calendar Assignment screen**

```
[10025088]          - Calendar Assignment -          [Admin]

Channels :    4-5
          - Browse Channels -
Filename  :    C:HUPPET.ULW
          - Browse -
Date     :    25/01-30/01
Time    :    09:00-11:00
          -> - Add to Calendar - <-
          - Exit -
```

To create a calendar assignment (without descriptor), follow the steps in Procedure 45.

**Procedure 45**

**Creating a calendar assignment (without descriptor)**

- 1 Enter the channel(s) where the announcement will be assigned. **Browse** can be used to scan and select from the list of available channels. Use 's' to toggle the selection of channels.
- 2 Enter the filename of the announcement for which the assignment is being created. Select **Browse** to scan the list of available announcement files.
- 3 Enter the time of day when the announcement is to be played.
- 4 Enter the date, dates, or days when the announcement is to be played.
- 5 Select **Add to Calendar** to add the assignment to the calendar. This updates the calendar immediately.
- 6 Select **Exit** to return to the Calendar Operations menu.

————— *End of Procedure* —————



### The View Calendar Assignments screen

Select **-3-** at the Calendar Operations menu to access the View Calendar Assignments screen. See Figure 62.

**Figure 62**

#### View Calendar Assignments screen

```
[10025088]          - View Calendar Assignments -          [Admin]
[TUE 12/02/2002 13:25:17]

  ID  Date           Time           Descriptor           Filename
  000  25/01-30/01    09:00-11:00          every_friday       C:MUPPET.ULW
  003  ???             ???                  every_friday         C:TOPGUN.ULW
  001  Mon-Fri         *                    weekday              C:GEORGE.ALW
  002  *                01:00-02:00         lunch                C:TOPGUN.ULW

[Page 01 of 01 (4)]

Press 'I' to toggle information._
Press Enter to Exit.
```

**Note:** The View Calendar Assignments screen shows TUI assignments by putting “TUI” in the date column and the channel assignments in the time column.

The View Calendar Assignments screen lists all Calendar Assignments in order of specificity. The most specific assignments – those with the most specific time and date – come first. The current day, date, and time appear in the upper-left corner of the screen. The filename for any assignments that match the current date and time appear in bold type.

The right column lists the name of the user who created the assignment. Only the administrator or the user who created an assignment can remove the assignment.

In the sample screen that appears in Figure 62 on page 169, notice that the assignment using the descriptor “every\_Friday” has a time and date of “?”. This indicates that the descriptor “every\_Friday” has been deleted and the system could not be retrieve the time and date information. The system ignores this assignment until someone re-defines “every\_Friday”.

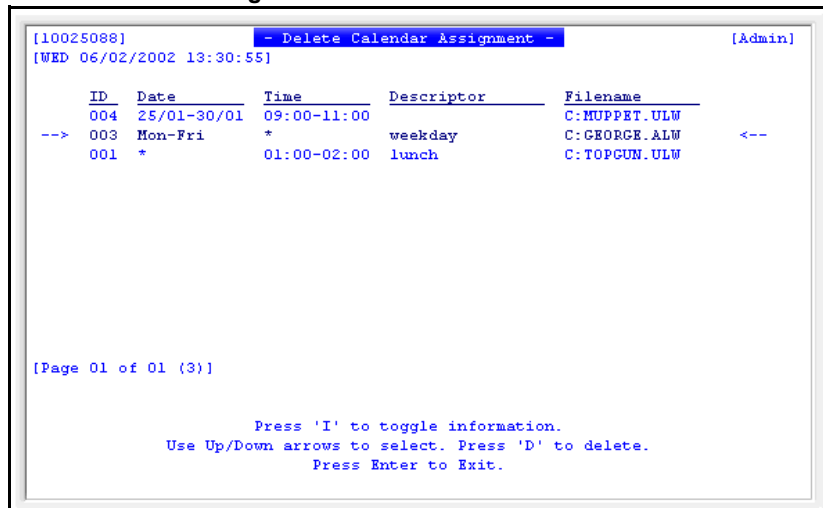
While in the View Calendar Assignments screen, the following actions can be performed:

- Press **I** to toggle the display for more information. The descriptor column lists the descriptor for each assignment, if there is one. The channel column lists the channels for each assignment.
- Press **Space bar** to list any more assignments that do not appear on the screen.
- Press **Enter** to exit this screen and return to the Calendar Operations menu.

**Delete Calendar Assignment screen**

Select - 4- at the Calendar Operations menu to access the Delete Calendar Assignment screen. See Figure 63.

**Figure 63**  
**Delete Calendar Assignment screen**



To delete a calendar assignment, follow the steps in Procedure 46.

**Procedure 46**

**Deleting a calendar assignment**

- 1** Use the up/down arrows to select the assignment to be deleted.
- 2** Press **D** to delete the selected assignment.
- 3** Press **Enter** to exit and return to the Calendar Operations menu.

————— *End of Procedure* —————

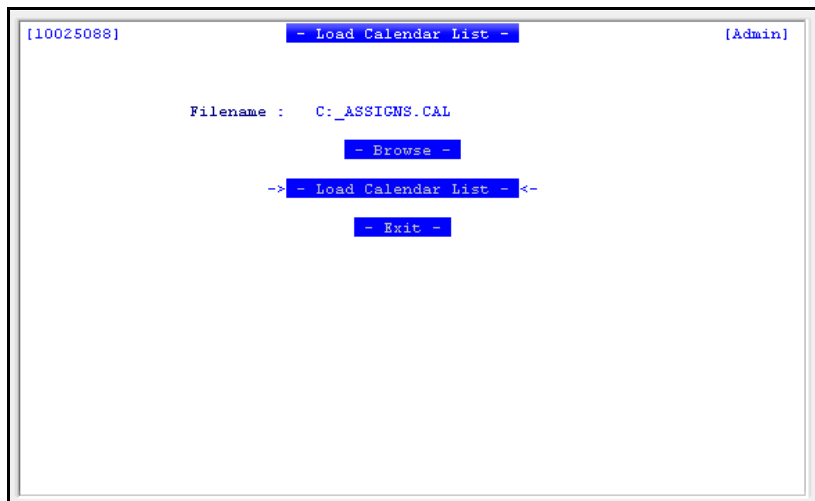
While in the Delete Calendar Assignment screen, press the **Space bar** to view more assignments.

### **Load Calendar List screen**

Select **-5-** at the Calendar Operations menu to access the Load Calendar List screen. See Figure 64.

A calendar list is a file that contains a collection of calendar assignments (for example, A:\_ASSIGNS.CAL). Use this screen to load a calendar list from any available drive. This screen is valuable as a quick way to activate a calendar configuration, such as, an emergency configuration, that had been previously saved.

**Figure 64**  
**Load Calendar List screen**



*Note:* This function only adds assignments to the calendar list. It does not clear (overwrite) existing assignments.

To load a calendar list, follow the steps in Procedure 47.

#### **Procedure 47** **Loading a calendar list**

- 1 Enter the filename of the calendar list to be loaded. Select **Browse** sed to scan the list of available calendar lists.
- 2 Select **Load Calendar List** to load the selected calendar list. A verification message is received.

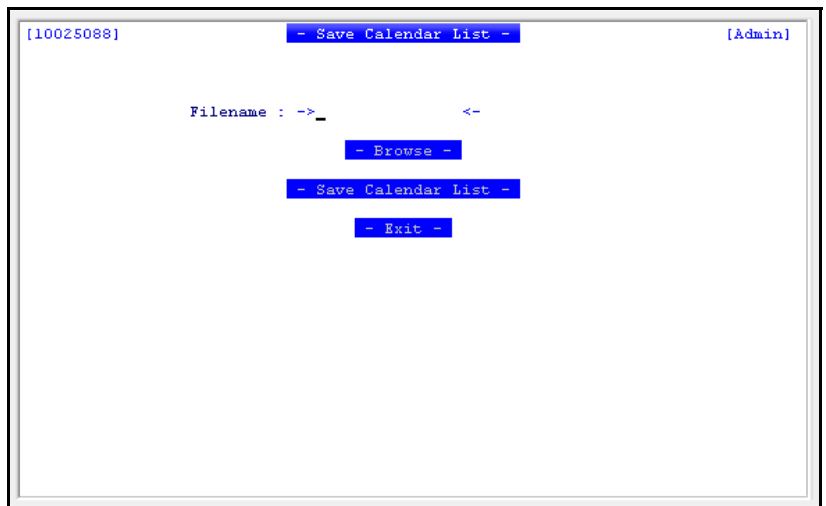
- 3 Select **Exit** to return to the Calendar Operations menu.

————— *End of Procedure* —————

### **Save Calendar List screen**

Select **-6-** at the Calendar Operations menu to access the Save Calendar List screen. See Figure 65. Use this screen to save the current set of calendar assignments in a single file location on any of the available drives. The resulting file can be transferred to another Succession Media Card or saved for future use.

**Figure 65**  
**Save Calendar List screen**



To save a calendar list, follow the steps in Procedure 48.

### **Procedure 48** **Saving a calendar list**

- 1 Enter the filename of the calendar list to be saved. Select **Browse** to scan the list of current calendar lists.
- 2 Select **Save Calendar List** to save the selected calendar list. A verification message is received.
- 3 Select **Exit** to return to the Calendar Operations menu.

————— *End of Procedure* —————

### ***Clear All Calendar Assignments screen***

Select **-7-** at the Calendar Operations menu to access the Clear All Calendar Assignments screen. See Figure 66. Use this screen to clear all of the current calendar assignments. This screen is useful when a MIRAN III Succession Media Card is reconfigured for a new customer or when significant changes to the calendar assignments are necessary.

**Figure 66**  
**Clear All Calendar Assignments screen**



The 'Clear all Calendar Assignments' command clears the current calendar list. If the configuration variable 'AutoSave' is TRUE (the default), this command also overwrites the existing calendar file, `_ASSIGNS.CAL`.



#### **CAUTION**

##### **Service Interruption**

The 'Clear all Calendar Assignments' command causes all active announcements to stop playing.

To clear all calendar assignments, follow the steps in Procedure 49.

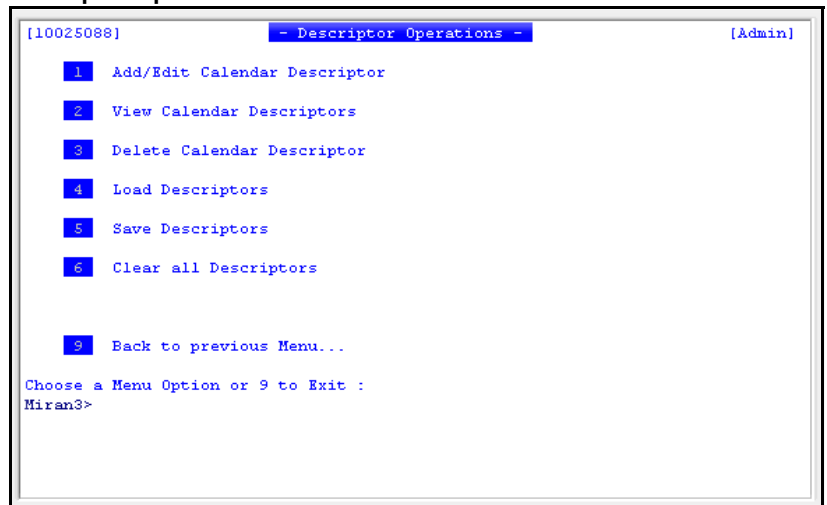
**Procedure 49****Clearing all calendar assignments**

- 1 Select **Clear all Calendar Assignments** to clear all calendar assignments. A verification message is received.
- 2 Select **Exit** to return to the Calendar Operations menu.

————— *End of Procedure* —————

**The Descriptor Operations menu**

At the Announcement Configuration menu, select **-2-** to access the Descriptor Operations menu. See Figure 67.

**Figure 67****Descriptor Operations menu**

```
[10025088]          - Descriptor Operations -          [Admin]
  1 Add/Edit Calendar Descriptor
  2 View Calendar Descriptors
  3 Delete Calendar Descriptor
  4 Load Descriptors
  5 Save Descriptors
  6 Clear all Descriptors

  9 Back to previous Menu...

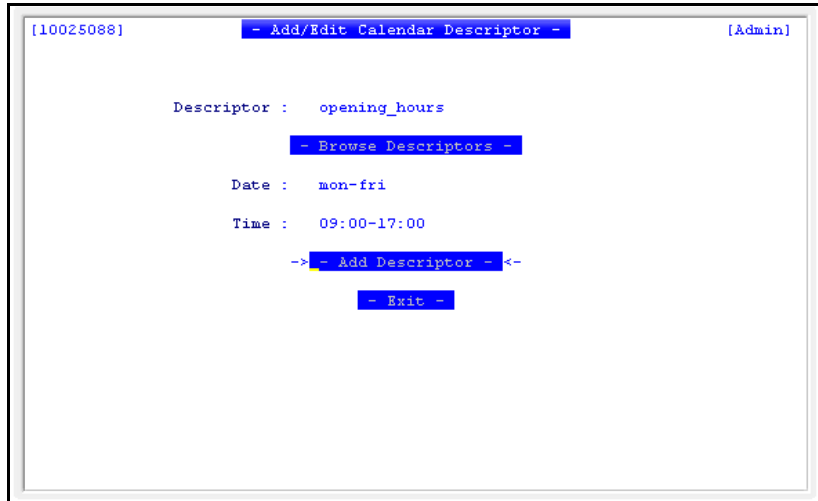
Choose a Menu Option or 9 to Exit :
Hiran3>
```

**Add/Edit Calendar Descriptor screen**

Select **-1-** at the Descriptor Operations menu to access the Add/Edit Calendar Descriptor screen. See Figure 68 on page 176. Create or edit a calendar using this screen.

A calendar descriptor has a time and date associated with it. The time and date definitions determine when an announcement that has a particular descriptor assignment plays. For example, Figure 68 shows an announcement that uses the descriptor 'opening\_hours' that plays from 9:00 a.m. to 5:30 p.m., Monday through Friday.

**Figure 68**  
**Add/Edit Calendar Descriptor screen**



To add or edit a calendar descriptor, following the steps in Procedure 50.

**Procedure 50**  
**Adding or editing a calendar descriptor**

- 1 Enter the name of the descriptor to be created or edited, a maximum of 16 characters in length. To edit a descriptor, select one from the list of existing descriptors by selecting **Browse Descriptors**.
- 2 Enter the date, dates, or days of the week during which the descriptor must operate.
- 3 Enter the time during which the descriptor must operate.



- 4 Select **Add Descriptor** to add the descriptor. This immediately affects any assignments that contain this descriptor.
- 5 Select **Exit** to return to the Descriptor Operations menu.

————— *End of Procedure* —————

### ***View Calendar Descriptors screen***

Select **-2-** at the Descriptor Operations menu to access the View Calendar Descriptors screen. See Figure 69. The right-hand column of the screen lists the creator of each descriptor. Only the administrator, or the user who created a descriptor, can delete the descriptor.

**Figure 69**  
**View Calendar Descriptors screen**

```
[10025088]          - View Calendar Descriptors -          [Admin]
[ WED 06/02/2002 13:58:44 ]

  Descriptor      Date      Time      Creator
  always          *          *          admin
  lunch           *          01:00-02:00  admin
  weekday         Mon-Fri   *          admin
  weekend          Sat-Sun   *          admin

-

[Page 01 of 01 (4)]

                          Press Enter to Exit.
```

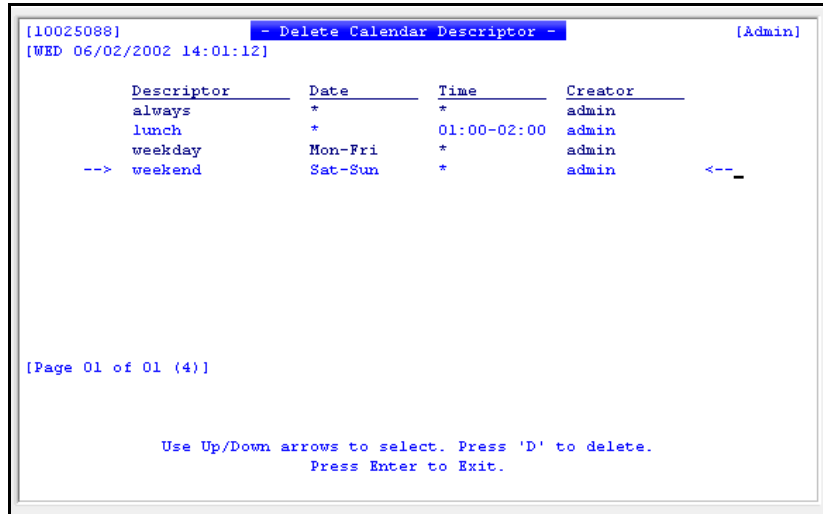
At the View Calendar Descriptors screen, the following actions can be performed:

- Press the **Space bar** to view more descriptors that do not appear on the initial screen.
- Press **Enter** to exit and return to the Descriptor Operations menu.

**Delete Calendar Descriptor screen**

Select **-3-** at the Descriptor Operations menu to access the Delete Calendar Descriptor screen. See Figure 70. The right-hand column of the screen lists the creator of each descriptor. Only the administrator, or the user who created a descriptor, can delete the descriptor.

**Figure 70**  
**Delete Calendar Descriptor screen**



To delete a calendar descriptor, follow the steps in Procedure 51.

**Procedure 51**  
**Deleting a calendar descriptor**

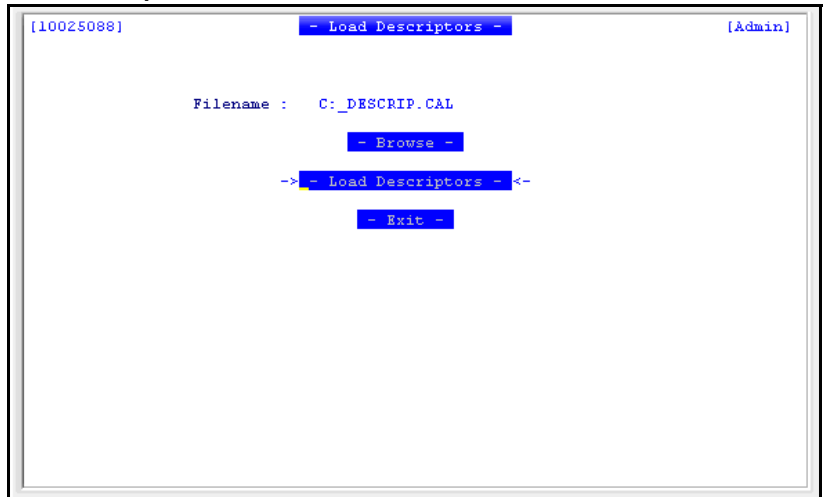
- 1 Use the up/down arrows to select the descriptor to be deleted. Press the **Space bar** to see more descriptors, if there are any.
- 2 Press **D** to delete the selected descriptor. This immediately affects any assignments that contain this descriptor. Any assignments that use this descriptor immediately become inactive.
- 3 Press **Enter** to exit and return to the Descriptor Operations menu.

————— *End of Procedure* —————

### ***Load Descriptor List screen***

Select **-4-** at the Descriptor Operations menu to access the Load Descriptor List screen. See Figure 71. A descriptor list is a file that contains a collection of descriptors (for example, A:\_DESCRIP.CAL). Use this screen to load a descriptor list from any available drive. This screen is a quick way to load the same descriptor configuration to several Succession Media Cards.

**Figure 71**  
**Load Descriptor List screen**



**Note:** This function only adds descriptors to the descriptor list. It does not clear (overwrite) existing descriptors.

To load a descriptor list, follow the steps in Procedure 52:

#### **Procedure 52** **Loading a descriptor list**

- 1 Enter the filename of the descriptor list to be loaded. Select **Browse** to scan the list of available descriptor lists.
- 2 Select **Load Descriptors** to load the selected descriptor list. A verification message will be received.
- 3 Select **Exit** to return to the Descriptor Operations menu.

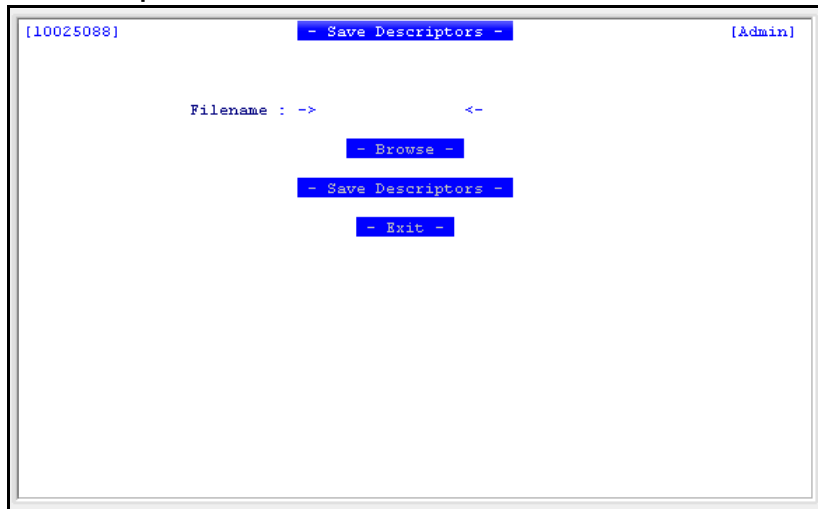
————— *End of Procedure* —————

### **Save Descriptor List screen**

Select **-6-** at the Descriptor Operations menu to access the Save Descriptor List screen. See Figure 72.

Use this screen to save the current set of descriptors in a single file location on any of the available drives. The resulting file can be transferred to another Succession Media Card or maintained for future use.

**Figure 72**  
**Save Descriptor List screen**



To save a descriptor list, follow the steps in Procedure 53.

#### **Procedure 53** **Saving a descriptor list**

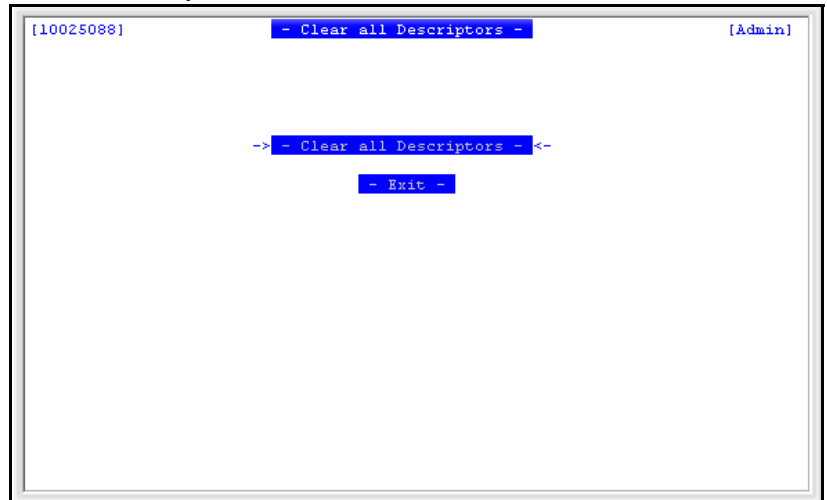
- 1 Enter the filename of the descriptor list to be saved. Select **Browse** to scan the list of available descriptor lists.
- 2 Select **Save Descriptors** to save the selected descriptor list. A verification message will be received.
- 3 Select **Exit** to return to the Descriptor Operations menu.

————— *End of Procedure* —————

**Clear All Descriptors screen**

Select **-6-** at the Descriptor Operations menu to access the Clear All Descriptors screen. See Figure 73. Use this screen to clear all current descriptor definitions. This screen is useful when a MIRAN III Succession Media Card is reconfigured for a new customer or when significant changes to the descriptor definitions are necessary.

**Figure 73**  
**Clear All Descriptors screen**



The 'Clear all Descriptors' command clears the current descriptors. If the configuration variable 'AutoSave' is TRUE (the default), this command also overwrites the existing descriptor file, `_DESCRIP.CAL`.

**CAUTION****Loss of Data**

The 'Clear all Descriptors' command clears all active descriptors. This renders 'inactive' all current calendar assignment that use descriptors. New descriptors must be defined or a new descriptor list loaded to re-activate these calendar assignments.

To clear all descriptors, follow the steps in Procedure 54.

**Procedure 54**  
**Clearing all descriptors**

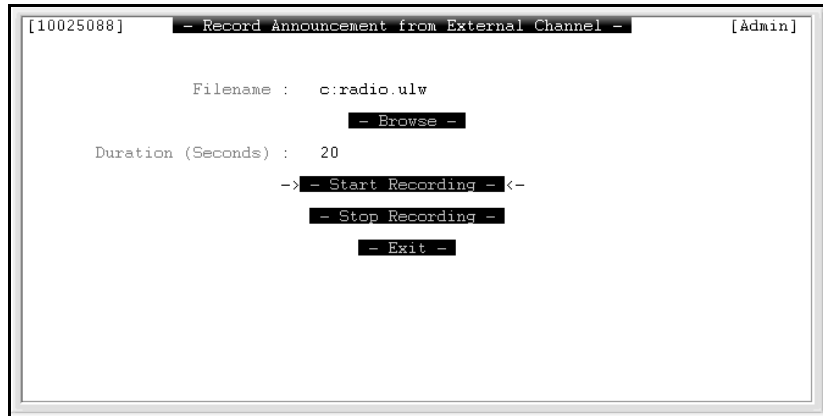
- 1 Select **Clear all Descriptors** to clear all descriptors. A verification message will be received.
- 2 Select **Exit** to return to the Descriptor Operations menu.

————— *End of Procedure* —————

**Record Announcement from External Channel screen**

At the Announcement Configuration menu, select **-3-** to access the Record Announcement from External Channel screen. See Figure 74. An announcement to the MIRAN III Succession Media Card is recorded here.

**Figure 74**  
**Record Announcement for External Channel screen**



To record an announcement to the MIRAN III Succession Media Card, follow the steps in Procedure 55.

**Procedure 55****Recording an announcement to the Succession Media Card**

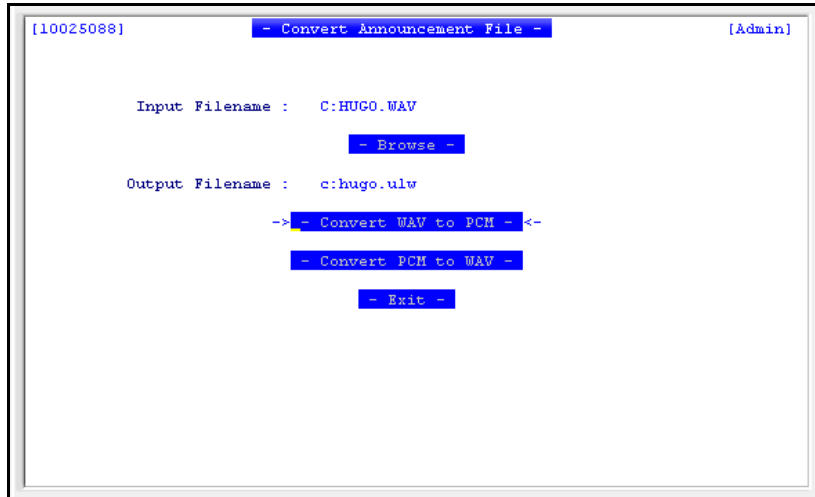
- 1 At the 'Filename' prompt, enter the filename of the announcement. A proper filename consists of eight alphanumeric characters with the appropriate three-letter extension (.ULW or .ALW). Remember to indicate on which drive the announcement file is to be saved.  
**Note:** Use **Browse** to ensure that the filename that is chosen does not already exist.
- 2 At the 'Duration' prompt, enter the length of time, in seconds, the announcement can last between 5 and 120 seconds.
- 3 Select **Start Recording** to start recording the announcement.
- 4 Select **Stop Recording** to stop recording. The MIRAN III stops recording either when the duration is reached, or when **Stop Recording is selected**, or when the file system is full.
- 5 Select **Exit** to return to the Announcement Configuration menu.

————— *End of Procedure* —————

**Convert Announcement File screen**

At the Announcement Configuration menu, select **-5-** to access the Convert Announcement File screen. See Figure 75 on page 184. Use this screen to convert an announcement file from .WAV format to .ULW or .ALW format, or the reverse.

**Figure 75**  
**Convert Announcement File screen**



To convert an announcement file, follow the steps in Procedure 56.

**Procedure 56**  
**Converting an announcement file**

- 1 At the 'Input Filename:' prompt, enter the filename to be converted. Select **Browse** to scan and select from the list of available files.
- 2 At the 'Output Filename:' prompt, enter the desired filename for the converted file. If an output filename is not entered, the file receives the same filename as the input filename, with the appropriate new extension.
- 3 Select **Convert WAV to PCM** to convert the file from .WAV format to .ULW or .ALW format. Select **Convert PCM to WAV** to convert the file from .ULW or .ALW format to .WAV format.

**Note 1:** The conversion process makes a duplicate of the input file. Ensure sufficient disk space is available for the conversion process, and delete unnecessary files.

**Note 2:** Announcements must be in A-law (.ALW) or  $\mu$ -law (.ULW) format, depending on the system's configuration, to play on MIRAN.



- 4 Select **Exit** to return to the Announcement Configuration menu.

*End of Procedure*

## Operational Statistics screen

At the MIRAN Administration menu, select **-2-** to access the Operational Statistics screen. See Figure 76. Use this screen to check the current traffic statistics of all the internal channels. The Succession Media Card cannot display the statistics of the external channels, because it cannot monitor the traffic on these channels.

**Figure 76**  
**Operational Statistics screen**

	Total	Last Hour	Average	Last Day	Average	Last Week	Average
0	62058	0	419	0	10343	0	0
1	53558	0	361	0	8926	0	0
2	11236	0	75	0	1872	0	0
3	11233	0	75	0	1872	0	0
4	19834	0	134	0	3305	0	0
5	11221	0	75	0	1870	0	0
6	11236	0	75	0	1872	0	0
7	11211	0	75	0	1868	0	0

Filename : -> -<

- Browse -
- Save Statistics -
- Clear Statistics -
- Exit -

*Note:* MIRAN updates the operational statistics every minute.

The following is an explanation of each statistical column for each channel:

- **Total** – is the total number of calls received for each channel since the last bootup of the Succession Media Card.
- **Last Hour** – is the number of calls received for each channel in the last 60 minutes.
- **Last Hour Average** – is the average number of calls received for each channel per hour since the last bootup of the Succession Media Card.

- **Last Day** – is the number of calls received for each channel in the last 24 hours.
- **Last Day Average** – is the average number of calls received for each channel per day since the last bootup of the Succession Media Card.
- **Last Week** – is the number of calls received for each channel in the last seven days.
- **Last Week Average** – is the average number of calls received for each channel per week since the last bootup of the Succession Media Card.

To save the current operational statistics to a file, follow the steps in Procedure 57.

#### **Procedure 57**

##### **Saving current operational statistics to a file**

- 1 Enter the desired filename for the file to be saved. Remember to indicate the drive where the file is to reside.

**Note:** Select **Browse** to choose an existing statistics file in which to save the statistics, or use **Browse** to ensure that the new filename does not already exist.

- 2 Select **Save Statistics** to save the statistics to the filename. The MIRAN generates a text file with values separated by commas.
- 3 Select **Exit** to return to the MIRAN Administration menu.

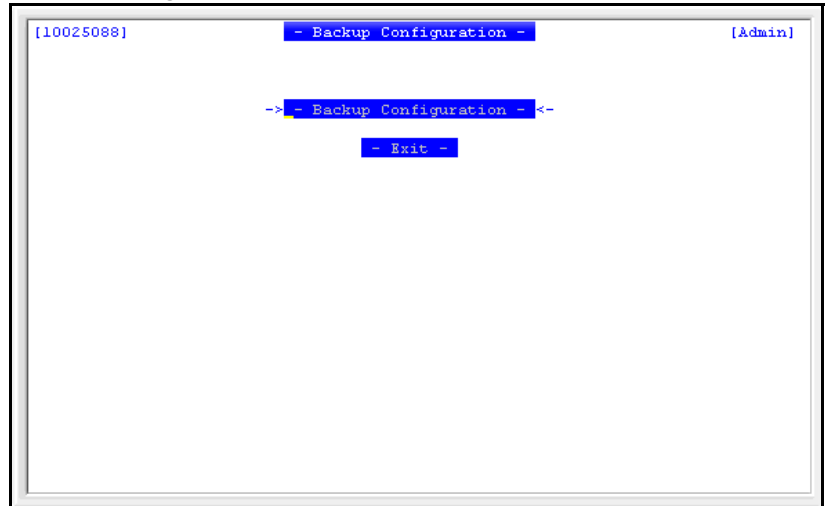
**Note:** Select **Clear Statistics** to reset all statistics on all channels.

————— *End of Procedure* —————

## **Backup Configuration screen**

At the MIRAN Administration menu, select **-3-** to access the Backup Configuration screen. See Figure 77 on page 187. This screen enables backup for the calendar, file descriptor, and configuration variable information. Backups can be configured to occur automatically, by setting the appropriate configuration variables. See “Configuration Variables menu” on page 203.

**Figure 77**  
**Backup Configuration screen**



*Note:* The MIRAN III Succession Media Card saves user information such as user names and passwords automatically to the C: drive. This is not part of the backup process.

To back up the configuration, follow the steps in Procedure 58.

**Procedure 58**  
**Backing up the configuration**

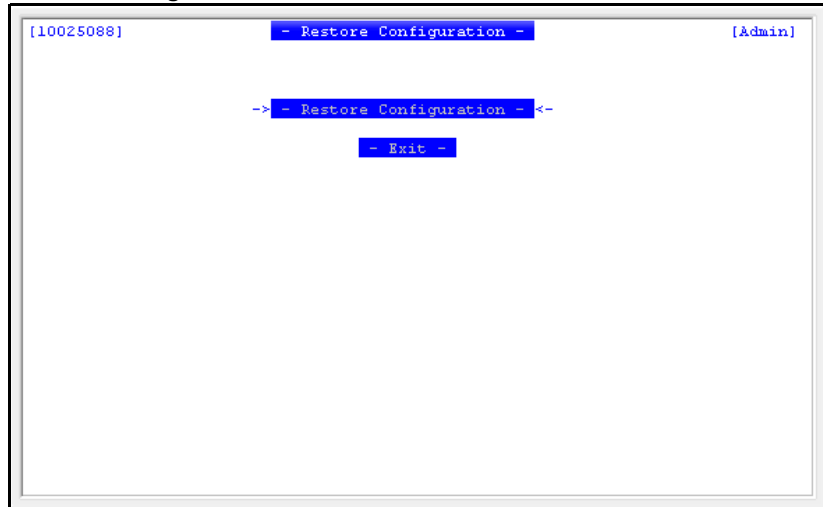
- 1 Select the storage device where the configuration will be backed up. This is usually a PC Card in the external A: drive.
- 2 Select **Backup Configuration** to start the backup process to the specified storage device.
- 3 When the backup is complete, select **Exit** to return to the MIRAN Administration menu.

————— *End of Procedure* —————

## Restore Configuration screen

At the MIRAN Administration menu, select **-4-** to access the Restore Configuration screen. See Figure 78. This screen enables the calendar, file descriptor, and configuration variable information to be restored. The most common use for this screen is to copy the configuration of another MIRAN III Succession Media Card in the system by using a PC disk.

**Figure 78**  
**Restore Configuration screen**



To restore the MIRAN III configuration from a backup device to a file, follow the steps in Procedure 59.

### **Procedure 59** **Restoring the MIRAN III configuration from a backup device to a file**

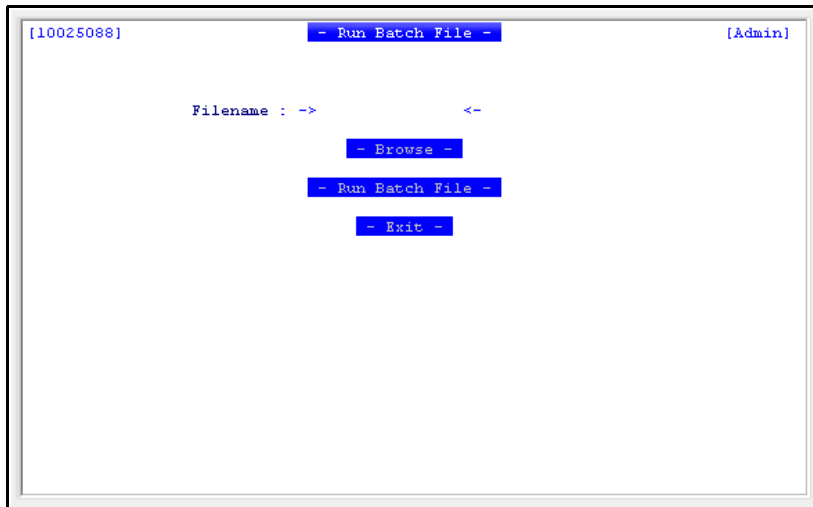
- 1 Select the storage device where the configuration is saved. This is usually a PC Card in the external A: drive.
- 2 Select **Restore Configuration** to start the restore process from the specified storage device.
- 3 When the restoration is complete, select **Exit** to return to the MIRAN Administration menu.

————— *End of Procedure* —————

## Run Batch File screen

At the MIRAN Administration menu, select **-5-** to access the Run Batch File screen. See Figure 79. This screen retrieves the standard file browser and asks for which batch file to run. The batch file runs immediately after it is selected.

**Figure 79**  
**Run Batch File screen**



To run a batch file, follow the steps in Procedure 60.

### **Procedure 60** **Running a batch file**

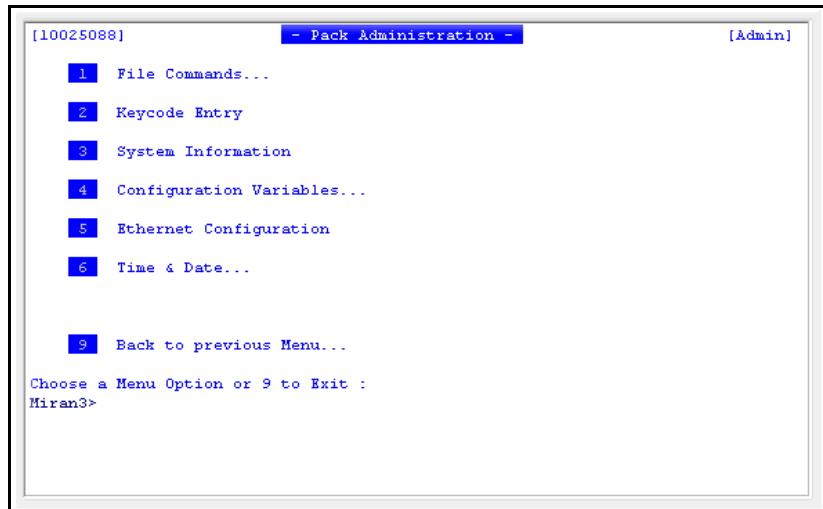
- 1 Select a batch file to run by using the up/down arrows on the keyboard.  
**Note:** Press **Space** to list more batch files.
- 2 Press **Enter** to run the selected batch file. MIRAN then returns to the MIRAN Administration menu.

————— *End of Procedure* —————

## Pack Administration menu

At the Main menu, select **-2-** to access the Pack Administration menu. See Figure 80.

**Figure 80**  
**Pack Administration menu**



At the Pack Administration menu, there are eight options:

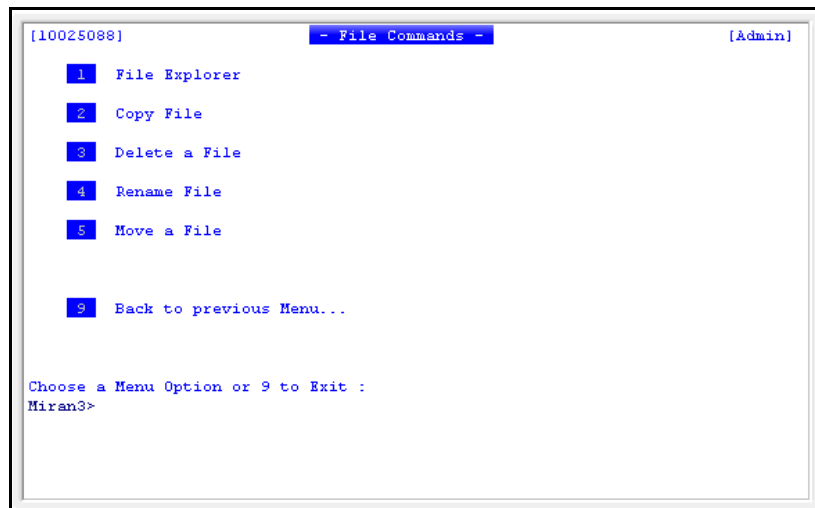
- **File Commands...** – enables the files to be explored, copied, deleted, renamed, and moved. Refer to “File Commands menu” on page 191.
- **Keycode Entry** – enables the keycodes to be entered for new MIRAN III Succession Media Cards, port size increases, and software upgrades. Refer to “Keycode Entry screen” on page 199.
- **Software Upgrade** – enables software upgrades using a PC Card. Refer to “Software Upgrade screen” on page 200.
- **System Information** – displays the MIRAN III Succession Media Card configuration and software release information. Refer to “System Information screen” on page 202.

- **Configuration Variables...** – enables the configuration variables to be viewed, edited, and saved. Configuration variables control certain aspects of the MIRAN III operation that are not obvious to the user. Refer to “Configuration Variables menu” on page 203.
- **Ethernet Configuration** – allows the IP address, the subnet mask, and the Gateway of the Succession Media Card to be set. This is necessary to enable LAN access to the Succession Media Card. Refer to “Ethernet Configuration screen” on page 206.
- **Time & Date Configuration** – enables the time and date of the MIRAN III Succession Media Card to be set in one of two ways: either manually, or retrieving the time and date automatically from the Meridian 1 and Succession CSE 1000 system. Refer to “Time & Date Configuration menu” on page 208.
- **Back to previous Menu...** – returns to the Main menu.

## File Commands menu

At the Pack Administration menu, select **-1-** to access the File Commands menu. See Figure 81 on page 191.

**Figure 81**  
**File Commands menu**



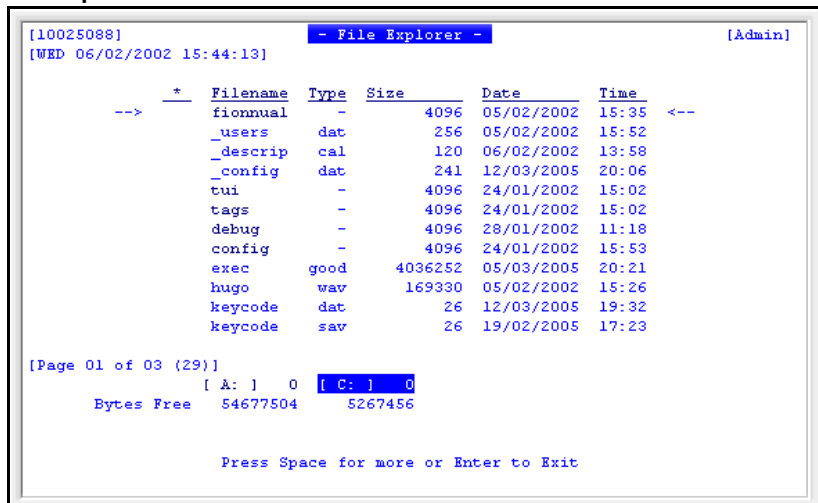
At the File Commands menu, there are six options:

- **File Explorer** – enables browsing through the directory file listings for the internal C: drive and any PC-based stored file lists. Refer to “File Explorer screen” on page 192.
- **Copy File** – enables a file to be copied to a different file on the same drive or another drive. Refer to “The Copy File screen” on page 193.
- **Delete File** – enables a selected file to be deleted. Refer to “Delete File screen” on page 195.
- **Rename File** – allows any existing file to be renamed. Refer to “Rename File screen” on page 196.
- **Move File** – allows a file to be copied to a specified location and the original source file deleted. Refer to “Move File screen” on page 197.
- **Exit** – returns to the Pack Administration menu.

### File Explorer screen

At the File Commands menu, select **-1-** to access the File Explorer screen. See Figure 82.

**Figure 82**  
**File Explorer screen**





At the File Explorer screen, the following actions can be performed:

- Select which drive's contents to explore. Use the right and left arrow keys to do this. The amount of storage space available on each drive appears below each drive letter.

**Note:** The PC Cards must be in place in the A: drive before the drive's contents can be checked. Allow approximately ten seconds after inserting a PC Card for the drive to mount.

- Use the up/down arrows to scroll through the list of files.
- Press **Enter** to return to the File Commands screen.

### **The Copy File screen**

At the File Commands screen, select **-2-** to access the Copy File screen. See Figure 83 on page 194.

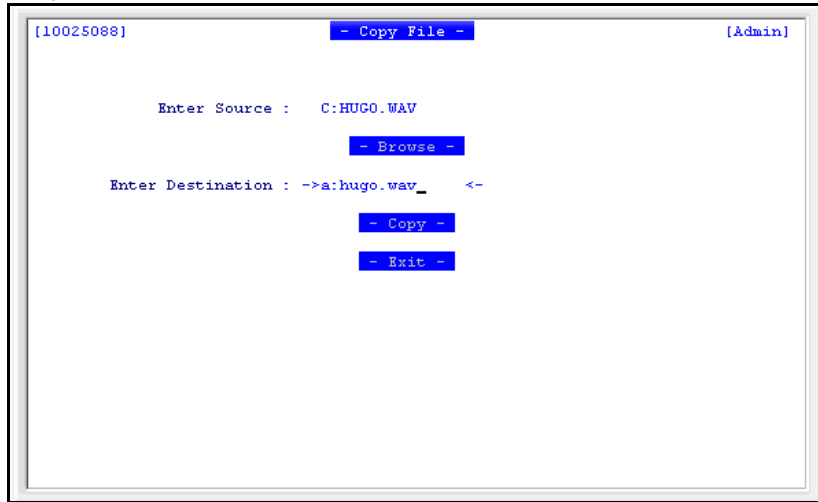


#### **CAUTION**

##### **Loss of Data**

Disable the MIRAN III Succession Media Card before transferring files between drives.

**Figure 83**  
**Copy Files screen**



To copy an existing file to a different file, follow the steps in Procedure 61.

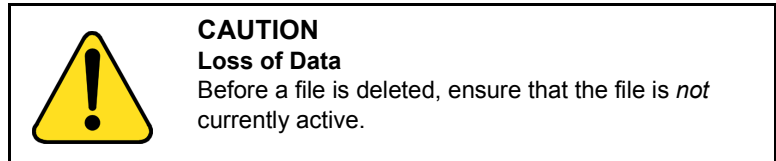
**Procedure 61**  
**Copying an existing file to a different file**

- 1 At the 'Source Filename:' prompt, enter the filename to be copied. Include the drive where the file resides. Select **Browse** to scan the list of available files.
- 2 At the 'Destination Filename:' prompt, enter the filename, including the drive, where the file will be copied. Select **Browse** to scan the list of available files.
- 3 Select **Copy** to copy the selected file from the source filename to the destination filename.  
**Note:** Steps 1 through 3 can be repeated as many times as needed before proceeding to step 4.
- 4 Select **Exit** to return to the File Commands screen.

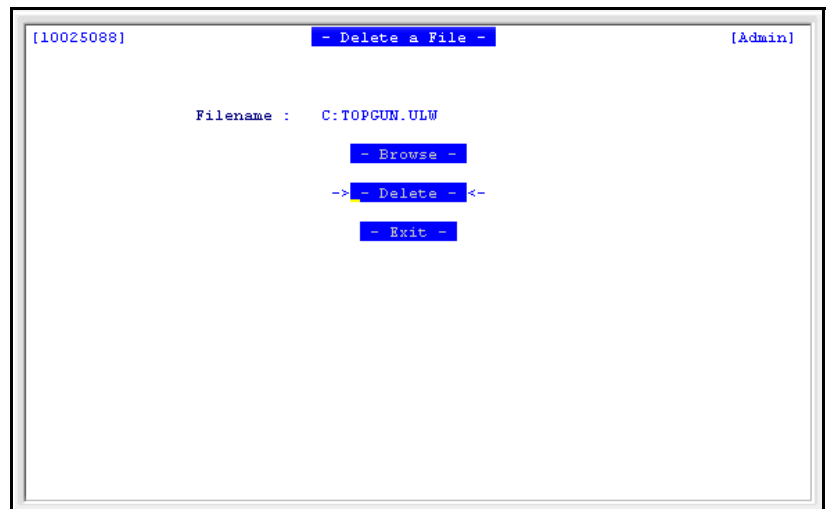
————— *End of Procedure* —————

## Delete File screen

At the File Commands screen, select **-3-** to access the Delete File screen. See Figure 84.



**Figure 84**  
**Delete File screen**



To delete a file, follow the steps in Procedure 62.

### **Procedure 62** **Deleting a file**

- 1 At the 'Filename:' prompt, enter the filename to be deleted. Include the drive where the file resides. Select **Browse** to scan the list of available files.
- 2 Select **Delete** to delete the selected file.


**Note:** Steps 1 and 2 can be repeated as many times as needed before proceeding on to step 3.

- 3 Select **Exit** to return to the File Commands screen.

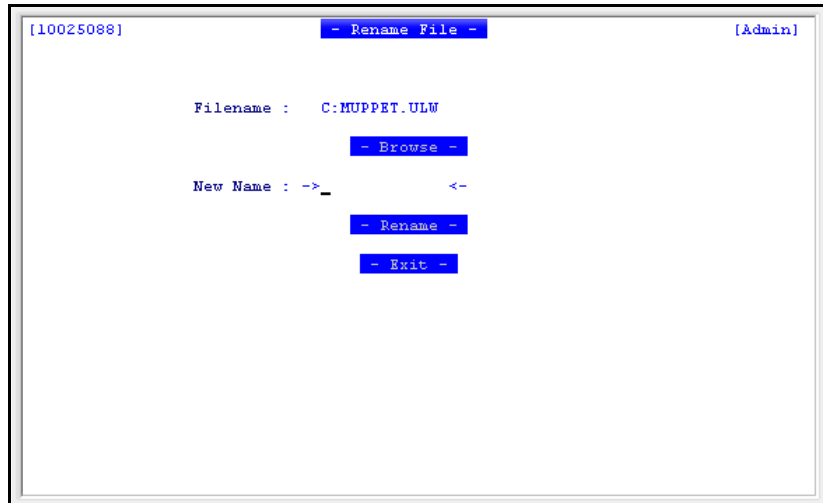
————— *End of Procedure* —————

### Rename File screen

At the File Commands screen, select **-4-** to access the Rename File screen. See Figure 85 on page 196.

	<p><b>CAUTION</b> <b>Loss of Data</b> Before a file is renamed, ensure that the file is <i>not</i> currently active.</p>
---	--

**Figure 85**  
**Rename File screen**



To rename a file, follow the steps in Procedure 63.

**Procedure 63**  
**Renaming a file**

- 1 At the 'Filename:' prompt, enter the filename to be renamed. Include the drive where the file resides. Select **Browse** to scan the list of available files.
- 2 At the 'New Name:' prompt, enter the new name for the file. Include the drive where the file will reside. Select **Browse** to scan the list of available files.
- 3 Select **Rename** to rename the selected file.  
**Note:** Steps 1 through 3 can be repeated as many times as needed before proceeding on to step 4.
- 4 Select **Exit** to return to the File Commands screen.

————— *End of Procedure* —————

**Move File screen**

At the File Commands screen, select **-5-** to access the Move File screen. See Figure 86 on page 198.

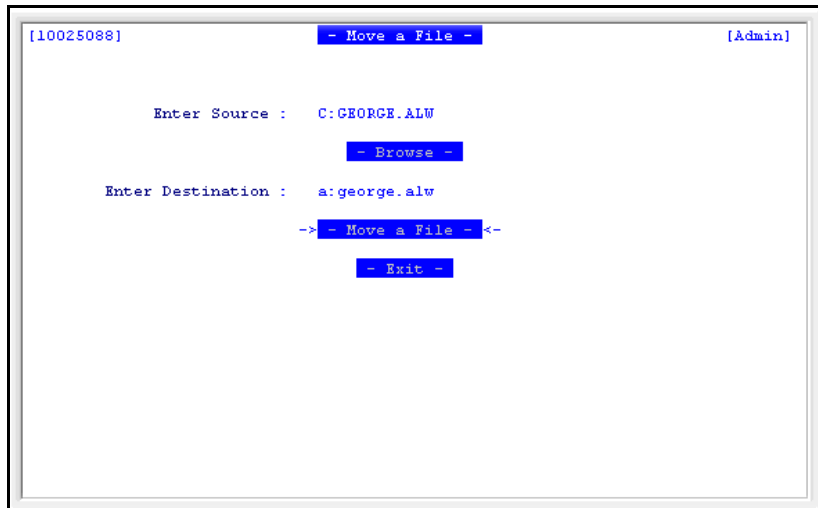


**CAUTION**

**Loss of Data**

Before a file is moved, ensure that the file is *not* currently active.

**Figure 86**  
**Move File screen**



To move a file from one location to another, follow the steps in Procedure 64:

**Procedure 64**  
**Moving a file from one location to another**

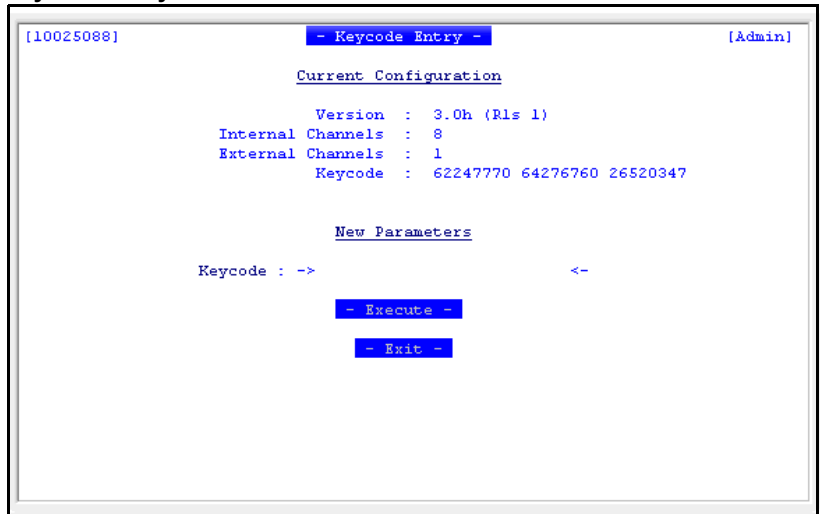
- 1 At the 'Source Filename:' prompt, enter the filename to be moved. Include the drive where the file resides. Select **Browse** to scan the list of available files.
- 2 At the 'Destination filename:' prompt, enter the filename, including the drive, where the file is to be moved. Select **Browse** to scan the list of available files.
- 3 Select **Move File** to move the selected file. This action deletes the source filename and places the file in the destination filename.  
**Note:** Steps 1 through 3 can be repeated as many times needed before proceeding on to step 4.
- 4 Select **Exit** to return to the File Commands screen.

————— *End of Procedure* —————

## Keycode Entry screen

At the Pack Administration menu, select **-2-** to access the Keycode Entry screen. See Figure 87 on page 199.

**Figure 87**  
**Keycode Entry screen**



```
[10025088]          - Keycode Entry -          [Admin]
                    Current Configuration
                    Version  : 3.0h (Rls 1)
                    Internal Channels : 8
                    External Channels : 1
                    Keycode   : 62247770 64276760 26520347

                    New Parameters
                    Keycode : ->                                     <-
                    - Execute -
                    - Exit   -
```

The Keycode Entry screen shows the current configuration, listing the MIRAN III software version, the number of internal and external ports, and the current keycode.

To change the keycode, follow the steps in Procedure 65:

### **Procedure 65** **Changing the keycode**

- 1 At the 'Keycode:' prompt, enter the new keycode. Remember to add a space between each group of eight numbers.
- 2 Select **Execute** to update the keycode. If the new keycode is valid, a 'Keycode Validated' message appears, and the system updates the current configuration information.

**Note:** If performing an upgrade, step 2 enables the upgrade.

- 3 Select **Exit** to return to the Pack Administration menu.

**Note:** To abort the keycode update, select **Exit** without selecting **Execute**.

————— *End of Procedure* —————

## Software Upgrade screen

At the Pack Administration menu, select **-3-** to access the Software Upgrade screen. See Figure 88 on page 200.

**Figure 88**  
**Software Upgrade screen**



The Software Upgrade screen can be used to upgrade to a new software version or to reload the existing software to fix a bug. If upgrading to a new software version, a new keycode must be entered. If simply fixing a bug, a new keycode is not needed.



### **CAUTION** **System Failure**

Do not reboot or power down the MIRAN III Succession Media Card during the software upgrade process. When the upgrade is complete, the system acknowledges with an 'OK'. **After 'OK' is displayed, do a COLD REBOOT on the card to activate the software upgrade.**



To perform a software upgrade, follow the steps in Procedure 66:

**Procedure 66**

**Performing a software upgrade**

- 1** At the 'Filename:' prompt, enter the file to be downloaded from the PC Card to the MIRAN III Succession Media Card internal Flash memory (C: drive), to upgrade the current software. Select **Browse** to scan the list of available upgrade files.
- 2** Select **Upgrade** to place the selected file into the internal Flash memory of the Succession Media Card.  
**Note:** The upgrade can take a while. Wait for the "Upgrade successful" message before proceeding.
- 3** After the upgrade is completed, select **Exit** to return to the Pack Administration menu.
- 4** Access the Keycode Entry screen to enter the keycode for the software upgrade. See "Keycode Entry screen" on page 199.  
**Note:** Step 4 is not necessary for a simple bug fix.
- 5** Go to the Cold Reboot screen to cold reboot the Succession Media Card. See "Maintenance and Diagnostics" on page 213. This activates the software upgrade.

---

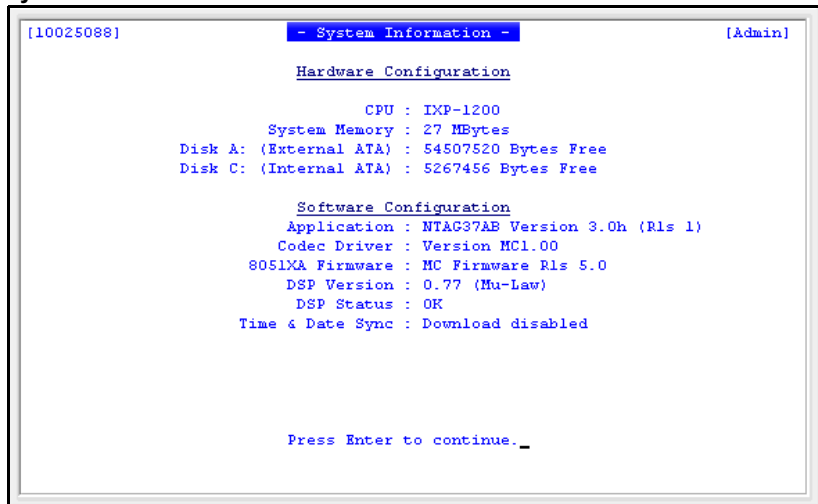
*End of Procedure*

---

## System Information screen

At the Pack Administration screen, select **-3-** to access the System Information screen. See Figure 89 on page 202.

**Figure 89**  
**System Information screen**



```
[10025088]          - System Information -          [Admin]

          Hardware Configuration

          CPU : IXP-1200
          System Memory : 27 MBytes
          Disk A: (External ATA) : 54507520 Bytes Free
          Disk C: (Internal ATA) : 5267456 Bytes Free

          Software Configuration
          Application : NTAG37AB Version 3.0h (Rls 1)
          Codec Driver : Version MCL.00
          8051XA Firmware : MC Firmware Rls 5.0
          DSP Version : 0.77 (Mu-Law)
          DSP Status : OK
          Time & Date Sync : Download disabled

          Press Enter to continue._
```

The System Information screen displays the following information:

- **Hardware Configuration** - including the CPU, the system memory, and the status of the drives.
- **Software Configuration** - including the application and firmware releases.

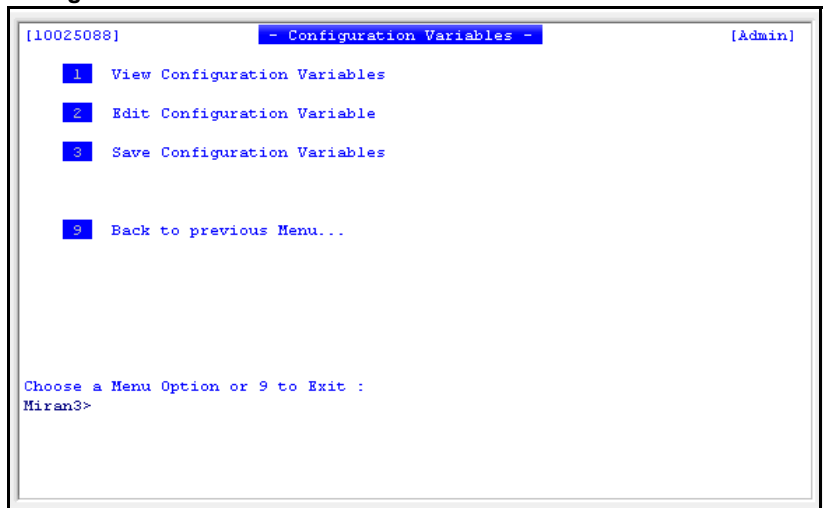
Use this information to help diagnose hardware or software issues that relate to a particular release of the product. When finished reviewing the system information, press **Enter** to return to the Pack Administration menu.

## Configuration Variables menu

Configuration variables are variables that control certain aspects of the operation of the MIRAN III Succession Media Card. These variables are not immediately visible to the user, and the default settings are usually sufficient. However, an administrator can view and change these variables when non-standard options are necessary. Table 14 on page 123 lists the configuration variables along with their values and descriptions.

At the Pack Administration screen, select **-5-** to access the Configuration Variables menu. See Figure 90 on page 203.

**Figure 90**  
**Configuration Variables menu**



```
[10025088]          - Configuration Variables -          [Admin]
1 View Configuration Variables
2 Edit Configuration Variable
3 Save Configuration Variables

9 Back to previous Menu...

Choose a Menu Option or 9 to Exit :
Miran3>
```

At the Configuration Variables menu, the following options are available:

- **View Configuration Variables** – enables the current values of all the configuration variables to be viewed. Refer to “View Configuration Variables screen” on page 204.
- **Edit Configuration Variables** – enables the current values of the configuration variables to be edited. Refer to “Edit Configuration Variables screen” on page 205.

- **Save Configuration Variables** – enables any changes made to the configuration variables to be saved. MIRAN III saves the current configuration variables when the option **-3-** is selected. There is no separate screen for this function; a confirmation message is simply received.

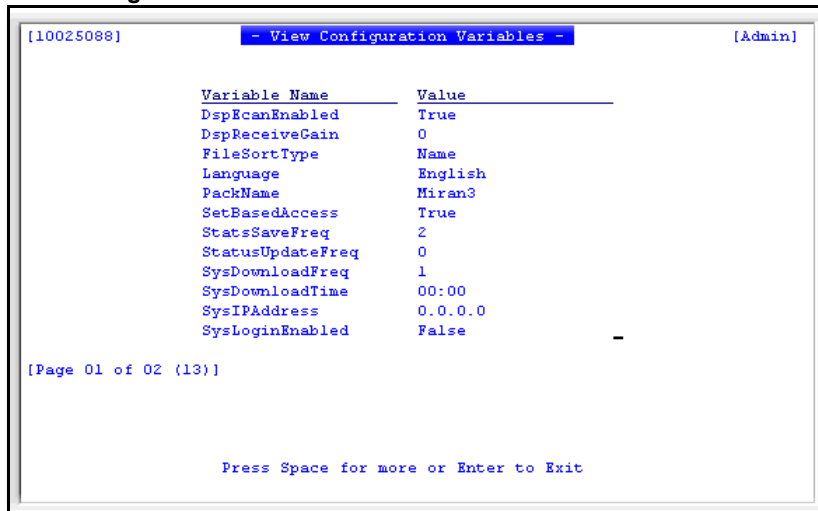
*Note:* This function saves the configuration variables to the default drive with the filename “\_CONFIG.DAT”.

- **Back to previous Menu...** – returns to the Pack Administration screen. Save any changes made to the configuration variables *before* exiting.

### View Configuration Variables screen

At the Configuration Variables screen, select **-1-** to access the View Configuration Variables screen. See Figure 91 on page 204.

**Figure 91**  
**View Configuration Variables screen**



At the View Configuration Variables screen, the following options are available:

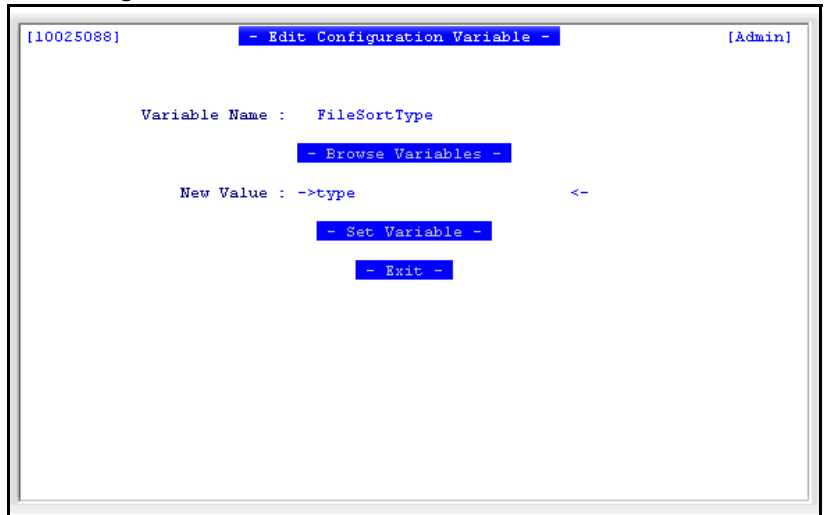
- Press **Space bar** to see more of the configuration variables.
- Press **Enter** to return to the Configuration Variables menu.

## Edit Configuration Variables screen

At the Configuration Variables screen, select **-2-** to access the Edit Configuration Variables screen. See Figure 92 on page 205.

**Figure 92**

### Edit Configuration Variables screen



To edit the configuration variables, follow the steps in Procedure 67:

#### Procedure 67

##### Editing the configuration variables

- 1 At the 'Variable Name:' prompt, enter the name of the variable to be edited. Select **Browse Variables** to scan and select from the list of available variables.
- 2 At the 'New Value:' prompt, enter the new value of the variable selected in step 1. Make sure that the value falls within the range of acceptable values according to Table 18 on page 112.
- 3 Select **Set Variable** to set the new value of the variable.  
**Note:** Steps 1 through 3 can be repeated for as many variables as needed.
- 4 Select **Exit** to return to the Configuration Variables menu.

- 5 At the Configuration Variables menu, select **-3-** to save the current (new) set of configuration variables.

————— *End of Procedure* —————



**CAUTION**  
**Loss of Data**

After configuration variables are edited at the Edit Configuration Variables screen, select **-3-** (Save Configuration Variables) at the Configuration Variables menu to save the changes. Otherwise the changes will not take effect.

## Ethernet Configuration screen

At the Pack Administration menu, select **-5-** to access the Ethernet Configuration screen. See Figure 93 on page 206.

**Figure 93**  
**Ethernet Configuration screen**

```
[10025088]          - Ethernet Configuration -          [Admin]

          Current Configuration
          IP Address : 47.85.15.62
          Subnet Mask : 255.255.240.0
          Gateway : 47.85.0.1
          IP Method : static

          New Configuration
          IP Address : 47.85.15.62
          Subnet Mask : 255.255.240.0
          Gateway : 47.85.0.1
          IP Method : static

          -> - Set - <-
          - Exit -
```

LAN access to the Succession Media Card is optional, but it is necessary to do any of the following:

- Use the embedded browser user interface to perform OA&M.
- Telnet into the Succession Media Card from a remote site.
- Transfer files to and from the Succession Media Card through FTP.

The IP address, the subnet mask, the Gateway, and the IP method for the Succession Media Card must be configured correctly to enable LAN access to the card. The MAC address is unique to each Succession Media Card; it cannot be changed.



**CAUTION**  
**System Failure**

Confer with the network administrator before setting the LAN parameters. Incorrect parameters can cause problems to other users in the network and can even lead to network outages.

To configure the MIRAN III Succession Media Card for LAN access, follow the steps in Procedure 68:

**Procedure 68**  
**Configuring the MIRAN III Succession Media Card for LAN access**

- 1 Under 'New Configuration:', enter the IP address at the appropriate prompt.
- 2 Enter the subnet mask at the appropriate prompt.
- 3 Enter the gateway at the appropriate prompt.

**Note:** The gateway IP address tells the Succession Media Card where the local gateway router is. This enables access from networks outside of the Succession Media Card's subnet. There is no need to enter a gateway IP address if only accessing a local subnet.

- 4 Enter the IP method at the appropriate prompt.  
**Note:** 'disabled' is the default, which makes the card inaccessible from the network even if the other parameters have been configured. Enter 'static' if using a static IP address that corresponds to the IP address that was entered on this screen. Enter 'bootp' to indicate that the card must request its IP address from a bootp server on the network.
- 5 Select **Set** to register the new IP address, subnet mask, gateway, and IP method. A valid LAN configuration receives an 'Ethernet Configuration Set' acknowledgment.
- 6 Select **Exit** to return to the Pack Administration menu.

---

*End of Procedure*

---

**Note:** The card must be rebooted for the new LAN configuration parameters to take effect.

## Time & Date Configuration menu

**Note:** To use the Time & Date Synchronization feature, LAN access for the Meridian 1 and Succession CSE 1000 must be configured. For instruction on how to configure the system, refer to "Configuring Ethernet for Time & Date Synchronization" on page 62.

At the Pack Administration menu, select **-6-** to access the Time & Date Configuration menu. See Figure 94 on page 209.



**Figure 94**  
**Time & Date Configuration Menu**

```
[10025088]          - Time & Date -          [Admin]

 1 Local Time & Date
 2 System Time & Date Synchronisation

 9 Back to previous Menu...

Choose a Menu Option or 9 to Exit :
Miran3>_
```

At the Time & Date Configuration menu, the following options are available:

- **Local Time & Date** – enables the time and date to be set on the Succession Media Card manually. Refer to “Local Time & Date screen” on page 210.
- **System Time & Date Synchronization** – enables the Succession Media Card to be configured to retrieve the time and date information automatically from the Meridian 1 and Succession CSE 1000 system. Refer to “System Time & Date Synchronization screen” on page 211.

### Local Time & Date screen

At the Time & Date Configuration menu, select **-1-** to access the Local Time & Date screen. See Figure 95 on page 210.

**Figure 95**  
**Local Time & Date screen**



To set the time and date for the MIRAN III Succession Media Card manually, follow the steps in Procedure 69:

#### **Procedure 69** **Setting the time and date for the MIRAN III Succession Media Card manually**

- 1 Enter the current time at the 'Time:' prompt.
- 2 Enter the current date at the 'Date:' prompt.  
**Note:** MIRAN automatically calculates the day of the week.
- 3 Select **-Set-** to set the time and date.
- 4 Select **-Exit-** to return to the Time & Date Configuration menu.

————— *End of Procedure* —————

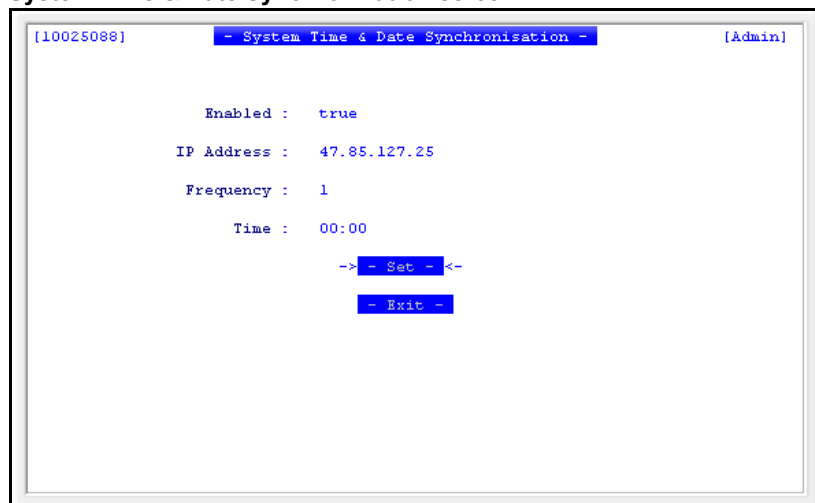
**Note:** This procedure performs the same operation as the SETTIME and SETDATE commands.

## System Time & Date Synchronization screen

At the Time & Date Configuration menu, select **-2-** to access the System Time & Date Synchronization screen. See Figure 96 on page 211.

**Figure 96**

### System Time & Date Synchronization screen



```
[10025088] - System Time & Date Synchronisation - [Admin]

Enabled : true
IP Address : 47.85.127.25
Frequency : 1
Time : 00:00

-> - Set - <-
- Exit -
```

To enable time and date synchronization with the Meridian 1 and Succession CSE 1000 system, follow the steps in Procedure 70:

### Procedure 70

#### Enabling time and date synchronization with the Meridian system

- 1 Set the 'Enabled:' prompt to **true**.
- 2 Enter the IP address of the Meridian 1 or Succession CSE 1000 system.

**Note:** The Meridian 1 or Succession CSE 1000 system must be on the same subnet as the MIRAN III Succession Media Card.

- 3 At the 'Frequency:' prompt, enter the number of days between each synchronization attempt (for example, enter **1** to synchronize every day).
- 4 At the 'Time:' prompt, enter the time of day the MIRAN III Succession Media Card will attempt to synchronize with the Meridian 1 or Succession CSE 1000 system.

**Note 1:** It is very important to schedule the time for synchronization during the period of *lowest* technician use (for example, *not* during midnight routines).

**Note 2:** The MIRAN III Succession Media Card makes one attempt to synchronize for each scheduled attempt. If the synchronization fails, the MIRAN III Succession Media Card keeps its current time and date configuration and tries to synchronize again at the next scheduled attempt.

- 5 Select **-Set-** to set the time and date synchronization.
- 6 Select **-Exit-** to return to the Time & Date Configuration menu.

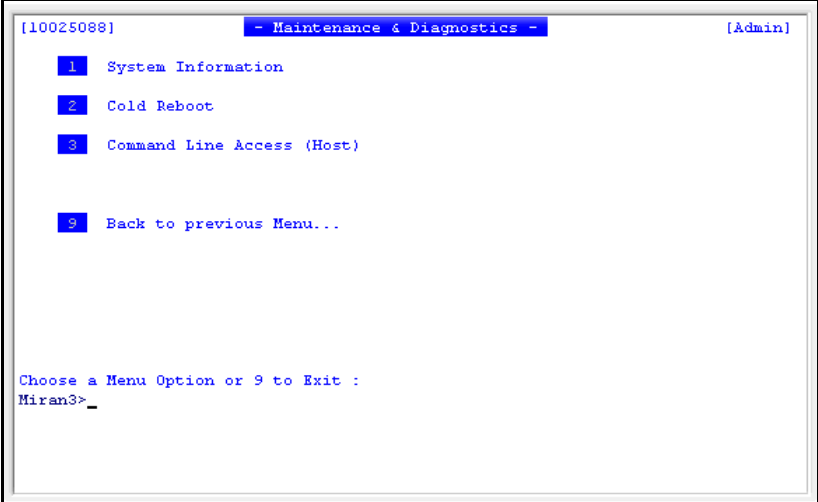
**Note:** The System Time & Date Synchronization requires the MIRAN III Succession Media Card to log into the Meridian 1 or Succession CSE 1000 system. This can affect other operations on the switch. Therefore, careful staging of the synchronization process is necessary.

————— *End of Procedure* —————

## Maintenance and Diagnostics

At the Main menu, select **-3-** to access the Maintenance and Diagnostics menu. See Figure 97 on page 213.

**Figure 97**  
**Maintenance & Diagnostics menu**



```
[10025088]           - Maintenance & Diagnostics -           [Admin]
  1 System Information
  2 Cold Reboot
  3 Command Line Access (Host)

  9 Back to previous Menu...

Choose a Menu Option or 9 to Exit :
Miran3> _
```

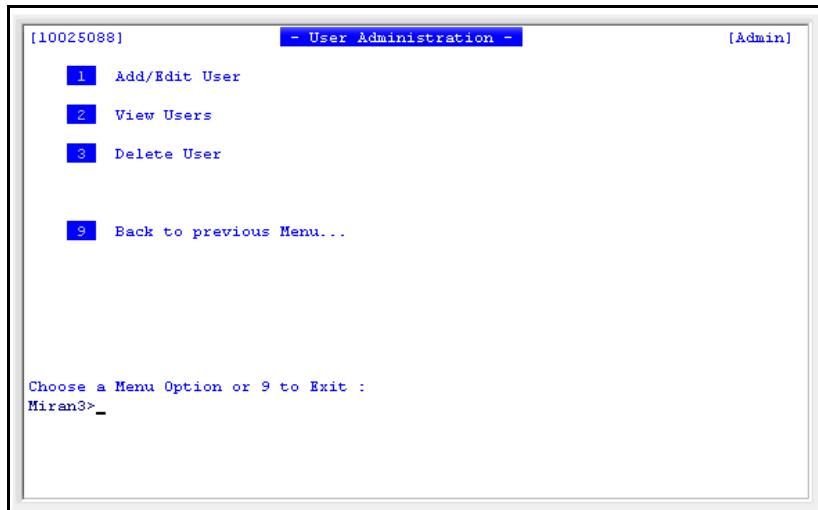
At the Maintenance and Diagnostics menu, with the proper level of access, the following actions can be performed:

- Select **-1-** to access the System Information screen. This is the same screen accessed from the Pack Administration menu. Refer to “System Information screen” on page 202 for details.
- Select **-2-** to perform a cold reboot of the MIRAN III Succession Media Card. This is a full system reboot.
- Select **-3-** to open the Command Line Access Host. Use this interface to perform PI testing and debugging.
- Select **-9-** to return to the Main menu.

## User Administration menu

At the Main menu, select **-4-** to access the User Administration menu. See Figure 98 on page 214. MIRAN III enables the configuration of multiple users for a single MIRAN III system. Only users with administrator privileges and above have access to this menu.

**Figure 98**  
**User Administration menu**



There are four options at the User Administration menu:

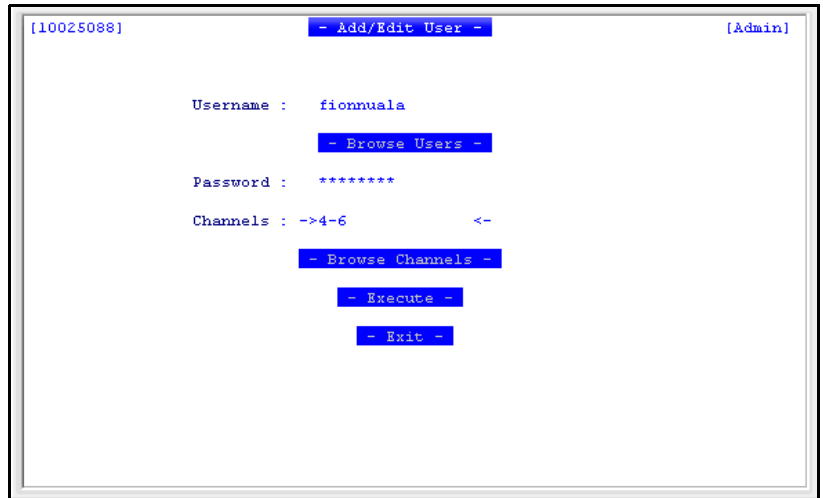
- Select **-1-** to add or edit a user. Refer to “Add/Edit User screen” on page 215.
- Select **-2-** to view a list of the users and their corresponding channel assignments. Refer to “View Users screen” on page 216.
- Select **-3-** to delete a user. Refer to “Delete User screen” on page 217.
- Select **-9-** to exit and return to the Main menu.

When a new user is defined, give the user a password and a group of channels that the user can access.

## Add/Edit User screen

At the User Administration menu, select **-1-** to access the Add/Edit User screen. See Figure 99 on page 215.

**Figure 99**  
**Add/Edit User screen**



```
[10025088]                - Add/Edit User -                [Admin]

Username :  fionnuala
                - Browse Users -
Password :  *****
Channels :  ->4-6                <-
                - Browse Channels -
                - Execute -
                - Exit -
```

To add or edit a user, follow the steps in Procedure 71:

### Procedure 71 Adding or editing a user

- 1 Enter the user name, which can be any combination of alphanumeric characters. If adding a new user, select **Browse** to ensure that the user name does not already exist. If editing an existing user, select **Browse** to select a name from the list of users.
- 2 Enter the new password for the user. The password must be at least eight alphanumeric characters. The maximum length is 12 characters.
- 3 Enter the channels that the user is allowed to access. Select **Browse Channels** to view and select from the list of available channels. Use 's' to toggle the selection of a channel.
- 4 Select **Add User** to save the new user information. This step updates the information on the C: drive automatically.

- 5 Select **Exit** to return to the User Administration menu.

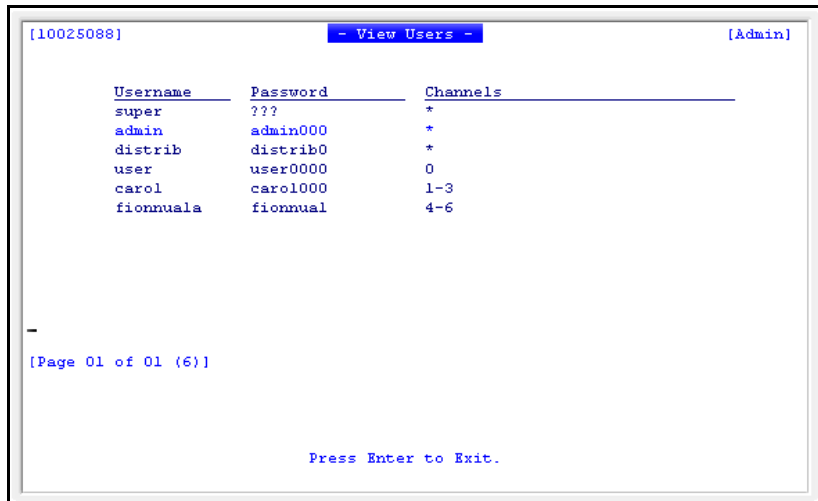
————— *End of Procedure* —————

*Note:* MIRAN III saves all user information in a file named “C:\_USERS.DAT”. All default users and passwords can be restored by deleting the C:\_USERS.DAT file.

## View Users screen

At the User Administration menu, select **-2-** to access the View Users screen. See Figure 100 on page 216. This screen lists the users’ names and the channels that each one has access to.

**Figure 100**  
**View User screen**



At the View Users screen, the following actions can be performed:

- Press the **Space bar** to view more users if they do not all appear on the initial screen.
- Press **Enter** to exit and return to the User Administration screen.



## Delete User screen

At the User Administration menu, select **-3-** to access the Delete User screen. See Figure 101 on page 217. This screen lists the users' names and the channels that each one is allowed to access.

**Figure 101**  
**Delete User screen**

```
[10025088]                - Delete User -                [Admin]

  Username      Password      Channels
  -----      -
  super         ???          *
  admin         admin000      *
--> distrib     distrib0       *          <--
  user          user0000      0
  carol         carol000     1-3
  fionnuala     fionnual       4-6

[Page 01 of 01 (6)]

Use Up/Down arrows to select. Press 'D' to delete.
Press Enter to Exit.
```

To delete a user, follow the steps in Procedure 72

### Procedure 72

#### Deleting a user

- 1 Use the up/down arrows to select the user to be deleted. If the user does not appear on the initial screen, press the **Space bar** for more users.
- 2 Press **D** to delete the selected user. This step updates the information on the C: drive automatically.
- 3 Press **Enter** to exit and return to the User Administration menu.

————— *End of Procedure* —————

## MIRAN III Succession Media Card OA&M command set

Instead of using the menu structure described in the first half of this chapter, commands can be entered on the command line in the Main Menu. This is advantageous to an experienced user who knows which command to use.

Most of these commands can also be used in batch files to allow complex configurations to be executed in a single command.

Files are specified using the DOS filenames convention of an eight-character filename followed by a three-character extension. The filename is normally preceded by a device descriptor as shown in Table 16 on page 218.

**Table 16**  
**MIRAN III Succession Media Card disk drives**

Drive name	Designation
External PC Card Drive	A:
Internal Flash Drive	C:

The MIRAN III Succession Media Card channels are named as shown in Table 17 on page 218:

**Table 17**  
**Channel designations**

Channels	Designation
Internal	0-7
Analog Inputs	ANALOG0/codec

These designators are used on the command line when executing MIRAN III Media card commands.

## OA&M Command summary

OA&M commands are used instead of using different menus to perform system applications configuration. A command is entered on the command line at the bottom of the Main Menu screen. See Figure 56 on page 161. For example:

```
MIRAN[00]>CON_WAV_PCM PLSWAIT.WAV ANN00005.ULW
```

Table 18 on page 219 lists MIRAN III Succession Media Card OA&M commands along with their descriptions, parameters, and syntax definitions. It also lists terminal-based OA&M access commands that can be entered on the command line on the terminal screen.

**Table 18**  
**OA&M command summary (Part 1 of 4)**

Command	Parameters	Function
BACKUP	[Device]	Backs up the assignment/configuration information.
CAL_ADD	[Channel list] [Device:Filename.Type] [Descriptor] or [Channel list] [Device:Filename.Type] [Time Entry] [Date Entry]	Adds a Calendar assignment.
CAL_CLEAR		Clears all Calendar assignments.
CAL_LOAD	[Device:Filename.Type]	Loads Calendar assignments from a file.
CAL_REMOVE	[Calendar Entry Number]	Removes a Calendar assignment.
CAL_SAVE	[Device:Filename.Type]	Saves Calendar assignments to a file.
COLD_RESET		Performs a cold reset on the pack.
CONV_PCM_WAV	[Input Device:Filename.ULW] [Output Device:Filename.WAV]	Converts a file from PCM (.ALW or .ULW) to WAV.

**Table 18**  
**OA&M command summary (Part 2 of 4)**

Command	Parameters	Function
CONV_WAV_PCM	[Input Device:Filename.WAV] [Output Device:Filename.ULW]	Converts a file from WAV to PCM (.ALW or .ULW).
COPY	[Source Device:Filename.Type] [Destination Device:Filename.Type]	Copy a file.
CVREAD	[Configuration Variable]	Shows the value of a configuration variable.
CVSAVE		Saves Configuration Variables to the drive specified by the variable 'DefaultDrive'.
CVSET	[Configuration Variable] [value]	Sets the value of a configuration variable. MIRAN III will save values if 'AutoSave' is TRUE.
DELETE	[Device:Filename.Type]	Deletes a file.
DESC_ADD	[Descriptor Name] [Time Entry] [Date Entry]	Adds/changes Calendar Descriptor.
DESC_CLEAR		Clears all Calendar Descriptors.
DESC_LOAD	[Device:Filename.Type]	Loads Calendar Descriptors from a file.
DESC_REMOVE	[Descriptor Name]	Removes a Calendar Descriptor.
DESC_SAVE	[Device:Filename.Type]	Saves Calendar Descriptors to a file.
ERASE_DIR	[Device:Directory]	Removes a directory and its contents.
IPCONFIG	[IP Address] [Subnet Mask] [Gateway Address] [IP Method]	Configures the IP information on the pack.
KEYCODE	[Keycode]	Capacity upgrade by means of a keycode.

**Table 18**  
**OA&M command summary (Part 3 of 4)**

Command	Parameters	Function
LIST	[Device:Filename.Type]	Lists files for a given drive.
LOCAL_TIME	[Time hh:mm] [Date dd/mm/yyyy]	Sets the time and date on the pack.
LOGOFF		Logs off and bring user back to the login screen.
MKDIR	[Device:Directory name]	Creates a directory.
MOVE	[Source Device:Filename.Type] [Destination Device:Filename.Type]	Moves a file.
PLAYSTOP	[External Channel]	Stops playback of a file on an external channel.
RECORD	[Device:Filename.Type] [Duration]	Records from an external channel to a file for a given duration.
RECORDSTOP	[External Channel]	Stops recording on an external channel.
RENAME	[Device:Old_File_Name.Type] [New_File_Name.Type]	Renames a file.
RESETSTAT		Resets channel statistics.
RESTORE	[Device]	Restores the backed-up assignment/configuration information.
RMDIR	[Device:Directory]	Removes an empty directory.
RUN	[Device:Filename.BAT]	Runs a batch file.
SAVESTATS	[Device:Filename.Type]	Saves channel statistics to a file.
SERIAL_PORT		Hands control of the serial port to the 8051XA for debugging purposes.

**Table 18**  
**OA&M command summary (Part 4 of 4)**

Command	Parameters	Function
SETDATE	[dd:mm:yyyy]	Sets the date on the pack.
SETTIME	[hh:mm]	Sets the time-of-day on the pack.
SETUP_PROMPTS	[Device:Directory]	Copies TUI voice prompts to a directory.
SHELL		Enters the vxWorks shell for debugging.
STATS		Shows channel statistics screen.
STATUS		Shows the pack status screen.
SW_UPGRADE	[Device:Filename.Type]	Upgrades the MIRAN III software.
SYSINFO		Shows the system information screen.
SYSTEM_TIME	[Enabled] [IP Address] [TTY Username] [TTY Password] [Frequency] [Time]	Sets the parameters for System Time & Date Synchronization.
SYSTEM_TIME_SY NC		Initiates the download of the System Time & Date from the Meridian 1 or Succession CSE 1000.
TIME		Shows the current day, time, and date
TUI_ASSIGN	[Channel] [Device:Filename.Type]	Makes a TUI calendar assignment.
TUI_UNASSIGN	[Channel]	Unassign a TUI assignment.
USER_ADD	[User Name] [Password] [Channel List]	Adds a new User.
USER_REMOVE	[User Name]	Removes a User.
VIEW	[Device:Filename.Type]	Views a text file.

## OA&M Commands

The command syntax explains in detail each command and its parameters.

### Read configuration variable

Use this command to show the value of a particular configuration variable.

Syntax                    **CVREAD** [Configuration Variable]  
[Configuration        The configuration variable to be read.  
Variable]

### Save configuration variables

Use this command to save the configuration variables to the drive specified by the variable 'DefaultDrive'.

Syntax                    **CVSAVE**

### Set configuration variable

Use this command to set the value of a configuration variable. The MIRAN III Succession Media Card will save the value if the variable 'AutoSave' is 'TRUE'.

Syntax                    **CVSET** [Configuration Variable] [Value]  
[Configuration        The configuration variable to be read.  
Variable]  
[Value]                The desired value of the configuration variable.

### Keycode entry

Enter a keycode to upgrade/activate software functionality.

Syntax                    **KEYCODE** [keycode]  
[keycode]        The keycode received in the upgrade/installation kit.

### Operational Statistics

Use this command to display a report of the RAN statistics.

Syntax                    **STATS**

### System Information

Use this command to display a report of the system hardware configuration.

Syntax **SYSINFO**

### View text file

Use this command to view a text file.

Syntax **VIEW** [dev:filename.type]  
[dev:filename.type] Device indicates on which drive the file resides. The filename is eight characters.

### Configure IP information

Use this command to configure the IP information for the MIRAN pack.

Syntax **IPCONFIG** [IP address] [subnet mask]  
[gateway address] [IP method]  
[IP address] The IP address for the MIRAN III Succession Media Card.  
[subnet mask] The subnet mask for the MIRAN III Succession Media Card.  
[gateway address] The gateway on which the MIRAN III Succession Media Card resides.  
[IP method] The method the MIRAN III Succession Media Card uses to obtain the IP address. The choices are:  
bootp – to take an IP address upon bootup  
static – to have a constant IP address  
disabled – to disable IP capability

### Allow 8051XA debugging

Use this command to hand control of the serial port to the 8051XA for debugging purposes.

Syntax **SERIAL\_PORT**



**Allow vxWorks debugging**

Use this command to enter the vxWorks shell for debugging purposes.

Syntax **SHELL**

**Synchronize time and date**

Use this command to initiate the download of time and date information from the Meridian 1 or Succession CSE 1000 system.

Syntax **SYSTEM\_TIME\_SYNC**

**Announcement Commands**

The following commands deal with announcements.

**Announcement Record**

This command records an announcement and stores it in a file. Recording starts immediately and terminates after the specified duration.

Syntax: **RECORD** [source] [device:filename] [duration]  
[source] ANALOG1, ANALOG2, CHANNEL 7 (for set)  
[device:filename] Device indicates on which device the file resides. The file name is a maximum of eight characters with a three-character extension.  
[duration] Maximum play duration in seconds.

**Stop Recording Announcement**

This command halts all announcement recording.

Syntax: **RECORDSTOP**

**Convert Announcement File**

This command converts audio files from one format to another. Raw PCM (.ULW or .ALW) is the default format used by the MIRAN III Succession Media Card. This utility allows conversion between any combination of the following formats:

Windows™ format audio file .WAV  
Raw PCM .ULW, .ALW

Syntax and description of announcement files

Syntax:	<b>CONV_PCM_WAV</b> [src dev:filename.ULW (or .ALW)] [dest dev:filename.WAV]
[src dev:filename.ext]	Device indicates on which device the file resides. The filename contains a maximum of eight characters.
[dest dev:filename.ext]	Device indicates on which device the converted file will be placed. The filename contains a maximum of eight characters.

## Calendar commands

The following commands deal with the calendar function.

### Add a calendar assignment

This command creates a calendar assignment using either a descriptor or a time and date entry to determine when the announcement plays.

Syntax:	<b>CAL_ADD</b> [channel list] [dev:filename.type] [descriptor] <u>or</u> <b>CAL_ADD</b> [channel list] [dev:filename.type] [time entry] [date entry]
[channel list]	Specifies on which channels the announcement will play.
[dev:filename.type]	Device indicates on which drive the file resides. The filename is eight characters.
[descriptor]	A previously defined descriptor that describes the times and date the announcement will play.
[time entry]	This is the time of day the announcement will play. Refer to Table 3 on page 29 for available formats.
[date entry]	This is the days or dates the announcement will play. Refer to Table 4 on page 30 for available formats.

**Remove a calendar assignment**

This command deletes a calendar assignment from the list of calendar assignments.

Syntax:                   **CAL\_REMOVE** [calendar entry number]  
[calendar entry       Specifies which calendar assignment to delete from  
number]                   among the list of calendar assignments.

**Load calendar assignments from a file**

Use this command to load a group of calendar assignments that were previously saved in a file.

Syntax:                   **CAL\_LOAD** [dev:filename.type]  
[dev:filename.type]     Device indicates on which drive the file resides.  
                            The filename is eight characters.

**Save a calendar list to a file**

Use this command to save the active list of calendar assignments to a file.

Syntax:                   **CAL\_SAVE** [dev:filename.type]  
[dev:filename.type]     Device indicates on which drive the file is to be  
                            saved. The filename is eight characters.

**Clear current calendar assignments**

Use this command to clear the currently active list of calendar assignments.

Syntax:                   **CAL\_CLEAR**

**Assign TUI announcement**

Use this command to assign a TUI announcement to a group of channels.

Syntax                   **TUI\_ASSIGN** [channel] [dev:filename.type]  
[channel]                The channel, or channels, on which the  
                            assignment is to be made. Use '\*' (star  
                            symbol) for all channels.  
  
[dev:filename.type]     Device indicates on which drive the file  
                            resides. The filename is eight characters.

### Unassign TUI announcement

Use this command to unassign a TUI announcement from a group of channels.

Syntax	<b>TUI_UNASSIGN</b> [channel]
[channel]	The channel, or channels, from which the assignment is to be removed. Use ‘*’ (star symbol) for all channels.

## Descriptor commands

The following commands deal with the descriptor function.

### Add a descriptor

Use this command to create a descriptor, which can be used for multiple calendar assignments.

Syntax:	<b>DESC_ADD</b> [descriptor name] [time entry] [date entry]
[descriptor name]	The name for the descriptor, from 1 to 16 characters in length.
[time entry]	This is the time of day an announcement with this descriptor will play. Refer to Table 3 on page 29 for available formats.
[date entry]	This is the days or dates an announcement with this descriptor will play. Refer to Table 4 on page 30 for available formats.

### Remove a descriptor

Use this command to delete a descriptor from the current list of descriptors.

Syntax:	<b>DESC_REMOVE</b> [descriptor name]
[descriptor name]	The name of the descriptor to be removed.

**Load descriptors from a file**

Use this command to load a group of descriptors that was previously saved in a file.

Syntax:                   **DESC\_LOAD** [dev:filename.type]  
[dev:filename.type]   Device indicates on which drive the file resides.  
                          The filename is eight characters.

**Save current descriptors to a file**

Use this command to save the active list of descriptors to a file.

Syntax:                   **DESC\_SAVE** [dev:filename.type]  
[dev:filename.type]   Device indicates on which drive the file is to be  
                          saved. The filename is eight characters.

**Clear current descriptors**

Use this command to clear the currently active descriptors.

Syntax:                   **DESC\_CLEAR**

**User commands**

The following commands deal with the list of users.

**Add a user**

Use this command to define a user.

Syntax:                   **USER\_ADD** [user name] [password] [channel list]  
[user name]               The name of the user (the login ID).  
[password]                The password the user must enter to access the  
                              Succession Media Card. The password *must* be  
                              eight characters long.  
[channel list]             The list of channels that the user will be able to  
                              access. For access to all channels, enter '\*' (star  
                              symbol).

**Note:** MIRAN III saves all user information in a file named "C\_USERS.DAT". All default users and passwords can be restored by deleting the C:\_USERS.DAT file.

### Remove a user

Use this command to delete a user from the current list of users.

Syntax:                **USER\_REMOVE** [user name]  
[user name]            The name of the user to be removed.

## File Commands

This command controls RAN and music files.

### List Files

Use this command to list all the files on the specified device or drive:.

Syntax:                **LIST** [device:] [filename] [.extension]  
[device:]              Device indicates on which device the file resides.  
[filename:]            Filename, max eight characters or wildcard "\*" (star symbol). If a filename is omitted then all files on the specified device will be listed.  
[.extension:]         The extension can be a maximum of three characters or wildcard "\*" (star symbol). If an extension is omitted then all files with a null extension on the specified device will be listed.

### Copy File

Use this command to copy files:

Syntax:                **COPY** [src device:filename.ext] [dest  
device:filename.ext]  
[src  
dev:filename.ext]     Device indicates on which device the file resides.  
Filename is a maximum of eight characters and the extension a maximum of three characters.  
[dest  
dev:filename.ext]     Device indicates on which device the copied file will be placed. Filename is a maximum of eight characters and the extension a maximum of three characters.

### Move File

This command moves files from a source to a destination location:

Syntax:           **MOVE** [src device:filename.ext] [dest device:filename.ext].

[src               Device indicates on which device the file resides.  
dev:filename.ext] Filename is a maximum of eight characters and the extension a maximum of three characters.

[dest              Device indicates on which device the moved file will  
dev:filename.ext] be placed. Filename is a maximum of eight characters and the extension a maximum of three characters.

### Delete file

This command deletes a file:

Syntax:           **DELETE** [dev:filename.ext]

[dev:filename.ext] Device indicates on which device the file resides. Filename is a maximum of eight characters and the extension a maximum of three characters.

### Rename File

This command renames a file:

Syntax:           **RENAME** [old dev:filename.ext] [new filename.ext].

[old               Device indicates on which device the original file  
dev:filename.ext] resides. Filename is a maximum of eight characters and the extension a maximum of three characters.

[new               The new filename is a maximum of eight characters  
filename.ext]       and the extension a maximum of three characters.

### Backup configuration

This command copies all active configuration announcement files to the specified destination.:

Syntax:           **BACKUP** [destination]

[destination]      This can be one of the following, device: - logical storage device A: or C:  
ANALOG0 - Analog output port 0

### Restore configuration

This command restores files that were backed up using the BACKUP command. Only files that were backed up to a logical device can be restored:

Syntax:               **RESTORE** [device:]  
[device:]             Device indicates on which device the backed up file resides.

### Software upgrade

This command upgrades the MIRAN III operating system and application software to the version stored on the specified device:

Syntax:               **SW\_UPGRADE** [device:]  
[device:]             Device indicates on which device the new software resides.

### Run Batch File

This command runs batch files:

Syntax:               **RUN** [device:filename.BAT]  
[device:filename]    Device indicates on which device the file resides. Filename is a maximum of eight characters. The extension.BAT will be assumed.

### Make a directory

Use this command to create a directory on a particular drive.

Syntax                **MKDIR** [device:directory]  
[device:             The drive where the directory is to be made, directory]            either A: or C: drive.  
                      The name for the directory

### Remove a directory

Use this command to remove a directory from a particular drive.

Syntax                **RMDIR** [device:directory]  
[device:             The drive from where the directory will be removed, either A: or C: drive. directory]            The name of the directory to be removed



**Erase a directory**

Use this command to remove a directory and its contents from a particular drive.

Syntax	<b>ERASE_DIR</b> [device:directory]
[device:	The drive from where the directory is to be removed, either A: or C: drive.
directory]	The name of the directory to be erased.

**Copy royalty-free music to the C: drive**

Use this command to copy the files, MUSIC.MCF and MIRANII.PDF, from the A: drive to the C: drive.

Syntax	<b>SETUP_C</b> [device]
[device]	The drive from where the files are to be copied, A: drive.

**Copy TUI voice prompts to a directory**

This command copies the TUI voice prompts to a directory.

Syntax:	<b>SETUP_PROMPTS</b> [device:directory]
[device:	The drive to which the prompts will be copied, either A: or C: drive.
directory]	The name of the directory where the prompts are to be copied.

**Miscellaneous Commands**

These commands configure and display time and date parameters.

**Set Time and Date**

This command sets the time *and* date on the MIRAN III Succession Media Card:

Syntax:	<b>LOCAL_TIME</b> [Time] [Date]
[Time]	Time of day in hours and minutes (hh:mm).
[Date]	The date (dd/mm/yyyy).

### Set Time of Day

This command sets the time of day:

Syntax:           **SETTIME** [HH:MM]  
[HH:MM]           Time of day in hours and minutes.

### Set the date

This command sets the date for the internal calendar:

Syntax:           **SETDATE** [day of month / month / year]

### Configure System Time and Date synchronization

This command sets the parameters for System Time and Date synchronization.

Syntax:           **SYSTEM\_TIME** [enabled] [IP address] [TTY  
username] [TTY password] [frequency] [time]  
[enabled]         Must be 'true' for System Time & Date  
synchronization to work.  
[IP address]      The IP address of the Meridian 1 or Succession  
CSE 1000 system.  
[TTY username]    The username used to access the Meridian 1 or  
Succession CSE 1000 system through the embedded  
LAN.  
[TTY password]    The password used to access the Meridian 1 or  
Succession CSE 1000 system through the embedded  
LAN.  
[frequency]       The number of days between each synchronization  
attempt, from 1 to 7 days.  
[time]            The time of day for the MIRAN III Succession Media  
Card to attempt to synchronize with the Meridian 1 or  
Succession CSE 1000 system. Set the time for the  
period of *lowest* technician use.

### Display Day and Time

This command shows the current day-of-week and time.

Syntax:           **TIME**

**Show Pack Status**

This command shows the pack status screen.

Syntax:               **STATUS**

**Show Statistics**

This command shows the current statistics for channel usage.

Syntax:               **STATS**

**Save Statistics**

Saves the current operational statistics to a file.

Syntax:               **SAVESTATS** [dev:filename.type]  
[dev:filename.type]   Device indicates to which drive the file will be saved. The filename is eight characters.

**Clear Statistics**

This command resets all of the statistics values to zero.

Syntax:               **RESETSTAT**

**Cold reset**

This command activates a cold reset of the MIRAN III Succession Media Card.

Syntax:               **COLD\_RESET**

**Logoff**

This command logs the user out of the terminal OA&M.

Syntax:               **LOGOFF**

**MIRAN III batch file support**

The MIRAN III batch files are used to execute sequences of frequently used commands. The syntax of these commands is the same as for the command line. Comments are indicated by “#” (pound symbol) in the left-most column.

### **Restrictions**

The maximum number of lines for each batch file (including comments) is limited to 255.

Commands and comments can not be mixed on the same line.

### **Batch file example**

```
# Batch file INIT.BAT
# Initial channel assignments
# Copy speech file pls_hold from device A: to internal flash device C:
COPY A:PLS_HOLD.ULW C:
# Assign "please hold" announcement to channel 0
ASSIGN MON 0 C:PLS_HOLD.ULW 00:00
# Assign music connected to analog port 0 to channel 1
ASSIGN MON 1 ANALOG0 00:00
```

## **Setting up emergency announcements quickly**

Situations can arise where an emergency announcement must be set up to play on all channels and override all other announcements. MIRAN III provides an easy way to do this, using TUI.

To set up an emergency announcement on all channels, follow the steps in Procedure 73:

### **Procedure 73**

#### **Setting up an emergency announcement on all channels**

- 1** Log in to the TUI.
- 2** Record the emergency announcement.
- 3** Assign the emergency announcement to all channels.

**Note:** This assignment through the TUI overrides any previous assignments.

- 4 Once the emergency has passed, delete the TUI assignment through the browser or Text-based User Interface screens. This returns the MIRAN to normal operation.

**Note:** For instructions on using the TUI, refer to “RAN Application: Telephone User Interface” on page 239.

————— *End of Procedure* —————



---

# RAN Application: Telephone User Interface

---

## Contents

This section contains information on the following topics:

Description. . . . .	240
Restrictions on TUI access. . . . .	241
Using the TUI. . . . .	241
Login. . . . .	241
Navigating the Main menu. . . . .	242
Recording an announcement. . . . .	243
Assigning an announcement. . . . .	243
Retrieving channel information. . . . .	245
Example of using the TUI . . . . .	246
Voice prompts. . . . .	247
TUI flowcharts . . . . .	250

## Introduction

This chapter describes the MIRAN III Telephone User Interface (TUI), which can be used to perform certain OA&M functions.

To enable the TUI, you must first perform the following actions:

- Use Overlay 16 to build a DID route. See “Configuring the DID route for the TUI” on page 60.
- Use Overlay 14 to configure port/channel 7 of the MIRAN III Succession Media Card as a DID trunk. See “Configuring the MIRAN trunks” on page 61.

- Enter the keycode for the Succession Media Card. See “Keycode Entry screen” on page 199.
- Ensure that the configuration variable, ‘SetBasedAccess’, is set to TRUE. See “Configuration Variables menu” on page 203.

The TUI reduces the number of MIRAN III Succession Media Card ports available for RAN or music from eight to seven. Because there is no messaging between MIRAN III Succession Media Cards, port 7 must be reserved for the TUI on each Succession Media Card that requires this interface.

**Note:** If a MIRAN III Succession Media Card does not require the TUI, then all eight ports on the card are available for RAN or music.

## Description

A TUI within the MIRAN III application allows the application to be accessed from any local DTMF telephone.

**Note:** The DTMF telephone must have an Unrestricted Class of Service to access the TUI.

The TUI uses a series of simple voice menus and prompts for quick modification of announcements and other simple tasks. Extensive changes must be implemented through the Text-based User Interface or the Browser User Interface (BUI).

The TUI enables the following actions:

- Record new announcements.
- Play announcements.
- Assign and unassign announcements to MIRAN III Succession Media Card ports.
- Access the MIRAN III Succession Media Card security ID.

The following *cannot* be done through the TUI:

- Set the MIRAN III Succession Media Card clock.
- Assign time-of-day restrictions to announcements.



- Access system configuration functions.
- Change passwords.

The TUI allows a user to login and issue specific commands through the dialpad of a Meridian Digital Telephone or any standard DTMF telephone. For security, login requires a valid user name and password, which the administrator supplies. The MIRAN III Succession Media Card does not identify itself until a valid user name and password is entered. The following pages describe the TUI menus.

## Restrictions on TUI access

Toll calls (that is, dialing 0 or 1 as the first digit) to the TUI channel disconnect automatically if the NATL response is set to YES in Overlay 16. The same thing happens when the NFCR response is set to YES in Overlay 15. Set both prompts to NO to allow toll calls to the TUI. Set **CLS = UNR** in Overlay 11 to allow a DTMF telephone access to the TUI.

## Using the TUI

To perform application tasks over the DTMF telephone, the dialpad must be used. Press specific digits on the dialpad to login and issue specific commands, which the following sections describe.

### Login

To login to the MIRAN III Succession Media Card, follow the steps in Procedure 74:

#### **Procedure 74**

#### **Logging to the MIRAN III Succession Media Card**

- 1 Go off-hook.
- 2 Dial the DID route access code of the MIRAN III Succession Media Card.
- 3 At the voice prompt, enter '#' (pound symbol), then a user name followed by '\*' (star symbol). The default user name is "**8737**" (= "user").
- 4 At the next voice prompt, enter the password followed by '\*' (star symbol). The default password is "**87370000**" (= "user0000").

————— *End of Procedure* —————

If the login is valid, the TUI accesses the Main menu. If the login is not valid after three attempts, the system disables further access attempts for 20 minutes.

The following conditions can prevent a user from accessing the MIRAN III Media Card through the TUI:

- The user has made three invalid login attempts.
- NCOS, TGAR, or the Class of Service (for example, CLS = TENA) is restricted.
- The configuration variable 'SetBasedAccess' is set to 'FALSE'.

## Navigating the Main menu

When you access the Main menu, a recorded announcement lists the options for this menu. At the Main Menu, users can perform the following actions:

- Dial 1 to assign the current announcement to a channel.
- Dial 2 to play the current announcement.

*Note:* When login first occurs, the current announcement is the same as the first announcement within the available disk volumes.

- Dial 3 to review channel assignments.
- Dial 4 to go to the previous announcement.
- Dial 5 to record an announcement.
- Dial 6 to go to the next announcement.
- Dial 76 to delete the current announcement.

*Note:* When users dial 76 to delete the current announcement, all channel assignments that use the announcement must be removed.

- Dial 8 to hear the eight-digit MIRAN III security ID.
- Dial \* (star symbol) to stop an announcement that is playing.

*Note:* If no announcement is playing, dialing \* (star symbol) saves any announcements that have been credited and logs the user off of the TUI.

- Dial 9 to repeat the list of options.

## Recording an announcement

An announcement can be recorded through the TUI. The announcement can be assigned to channels through the TUI, Text-based User Interface, or BUI.

To record an announcement, follow the steps in Procedure 75:

### **Procedure 75**

#### **Recording an announcement**

- 1 At the Main menu, dial 5 to enter the Record menu.
- 2 At the Record menu, dial 5 to begin recording.
- 3 Dial \* (star symbol) to end the recording.

**Note:** If the drive capacity is reached *while* recording, the recording stops automatically.

- 4 Dial 2 to review the announcement, and/or dial 5 to record the announcement again. This step is optional.
- 5 Dial 1 to save the announcement.

————— *End of Procedure* —————

When the announcement is saved, MIRAN III assigns it the filename: “ANNxxxxx”, where “xxxxx” is the announcement number. MIRAN III adds the announcement to the first disk volume with available space of at least 64 kbytes or 8 seconds of recording. Then the TUI returns to the Main menu.

**Note:** Except while recording an announcement, dial 9 for help and then “\*” (star symbol) to return to the Main menu.

## Assigning an announcement

Through the TUI, an announcement can be assigned to channels 0 to 7. Nortel Networks does not recommend that an announcement be assigned to channel 7, as the Succession Media Card uses channel 7 for the TUI.

**Note:** An announcement can be assigned to channel 7, but it will not play unless channel 7 is reprogrammed as a RAN trunk.

Table 1 on page 244 lists the internal and cross-connect MIRAN III Succession Media Card ports/channels.

**Table 1**  
**Port/channel number assignments for the Telephone User Interface**

Channel Number	Description
0	Internal one-to-one port/channel
1	Internal one-to-one port/channel
2	Internal one-to-one port/channel
3	Internal one-to-one port/channel
4	Internal one-to-one port/channel
5	Internal one-to-one port/channel
6	Internal one-to-one port/channel
7	Internal one-to-one port/channel (alternatively used for TUI access).

To assign an announcement to a channel, follow the steps in Procedure 76:

**Procedure 76**

**Assigning an announcement to a channel**

- 1 At the Main menu, dial 2 to learn what the current announcement is. (This step is optional.)
- 2 At the Main menu, dial 1 to enter the Assignment menu.
- 3 Enter the list of channels to which the announcement must be assigned. Dial \* (star symbol) after each channel to separate it from the next channel.
- 4 Dial \* (star symbol) a second time to end the list.

————— *End of Procedure* —————

For example, at the Assignment menu enter **2\*3\*\*** to assign the current announcement to internal channels 2 and 3.

If the channel assignment is not valid, the TUI prompts the user to try again. If the channel assignment is valid, the MIRAN III Succession Media Card clears *all* TUI assignments for the selected channels and assigns the current announcement to them. The TUI announces a successful assignment and returns to the Main menu.

*Note:* Announcement assignments through the TUI cannot include time and date restrictions. To restrict an announcement on a channel to particular times and days, make the assignment through the Text-based User Interface or the BUI.

## Retrieving channel information

Through the TUI, the MIRAN III Succession Media Card can be queried for information about its channels. In the Channel Information menu, the announcements assigned to each channel can be heard.

Dial 3 at the Main menu to enter the Channel Information menu. At the Channel information menu, the following options are available:

- Dial 4 to go to the previous channel.
- Dial 6 to go to the next channel.
- Dial 76 to unassign any announcement from the current channel.
- Dial 9 for help.
- Dial \* (star symbol) to return to the Main menu.

Unlike deleting an announcement in the Main menu, dialing 76 in the Channel Information menu only unassigns the announcement from the current channel. Dialing 76 in the Channel Information menu does not delete the announcement.

## Example of using the TUI

Table 2 on page 246 lists the steps to follow to record and assign an announcement through the TUI.

**Table 2**  
**An example of using the TUI (Part 1 of 2)**

Step	User action	MIRAN response	Comments
1	Go off-hook.	Not Applicable	
2	Dial the access code for the MIRAN III Succession Media Card.	Voice prompt for user name	
3	Enter # (pound), followed by the user name and * (star symbol).	Voice prompt for user password	
4	Enter the password, followed by * (star symbol).	"Main Menu"	A "Login incorrect" message is received for wrong input.
5	Dial 5 to access the Record menu.	Voice menu of options available	
6	Dial 5 to record the announcement.	<BEEP>	Records one announcement into a temporary file.
7	Dial * (star symbol) to stop recording.	Menu of available options	Recording stops.
8	Dial 2 to verify the announcement.	Plays announcement from temporary file	If the announcement is acceptable, save it.
9	Dial 1 to save the announcement.	"Announcement saved as announcement xxxx"; "Main Menu"	The announcement is saved to storage and becomes the currently selected announcement.
10	Dial 1 to assign the announcement to MIRAN III Succession Media Card port(s).	"Assignment menu. Enter a list of channels separated by star. End the list with an extra star."	

**Table 2**  
**An example of using the TUI (Part 2 of 2)**

Step	User action	MIRAN response	Comments
11	Enter list of channels separated by * (star symbol). (Follow last channel by ** (2 star symbols))	"Assignments made"; "Main Menu"	The MIRAN III assigns the announcement to the selected channel(s).
12	Dial * (star symbol) to exit MIRAN III.	"Good-bye"	The TUI disconnects the user from the MIRAN III.
13	Go on-hook.	Not Applicable	

## Voice prompts

Table 3 on page 247 lists voice prompts and corresponding voice prompt IDs.

**Table 3**  
**TUI voice prompts (Part 1 of 4)**

Prompt ID	Prompt content
0-31	"Zero" to "thirty one"
32	"Analog..." as in " <b>Analog</b> Zero."
33	"Channel..." as in " <b>Channel</b> 5."
34	<BEEP>
35	"Access is currently disabled."
36	"Please try again later."
37	"Goodbye."
38	"Please enter your user name followed by star."
39	"Please enter your password followed by star."
40	"Three login attempts have failed. Access will be temporarily disabled."

**Table 3**  
**TUI voice prompts (Part 2 of 4)**

Prompt ID	Prompt content
41	"Login incorrect."
42	"Please try again."
43	"Main menu."
44	"Commands you can use are: Assign 1, play 2, record 5, delete 7-6, ID 8."
45	"To go to the next announcement, press 6."
46	"To go to the previous announcement, press 4."
47	"To exit, press star."
48	"There are no announcements available."
49	"Start of list."
50	"End of list."
51	"Pack ID is..." as in " <b>Pack ID is</b> 1-0-0-0-1-2-3-4."
52	"That option is not available."
53	"For help, press 9."
54	"Assignments saved."
55	"Assignment menu."
56	"Enter a list of channels, separated by star. End the list with an extra star."
57	"Invalid assignment."
58	"You do not have access to the following channels:"
59	"Assignments made."
60	"Record menu."
61	"To begin recording, press 5. To end recording, press star."



**Table 3**  
**TUI voice prompts (Part 3 of 4)**

Prompt ID	Prompt content
62	"Drive capacity exceeded."
63	"Error saving announcement."
64	"Recording stopped."
65	"To save the announcement, press 1. To review it, press 2. To re-record it, press 5."
66	"Announcement saved as announcement..."
67	"Error deleting announcement."
68	"Announcement deleted."
69	"Channel Information Menu."
70	"For Channel Information, press 3."
71	"To review the current channel, press 2."
72	"To go to the next channel, press 6."
73	"To go to the previous channel, press 4."
74	"To unassign the current channel, press 7-6."
75	"There is no announcement assigned to this channel."
76	"Assignment cleared."
77	"Welcome to MIRAN."
78	"Assignment cleared on channel..."
79	"OK"
80	"... and..."
81	"... to..."
82	"You have access to the following channels:"
83	"Invalid channel assignment."

**Table 3**  
**TUI voice prompts (Part 4 of 4)**

Prompt ID	Prompt content
84	"All internal channels."
86	"Channels..."
89	"Assignments cleared on channel..."
90	"Assignments cleared on..."

### **TUI flowcharts**

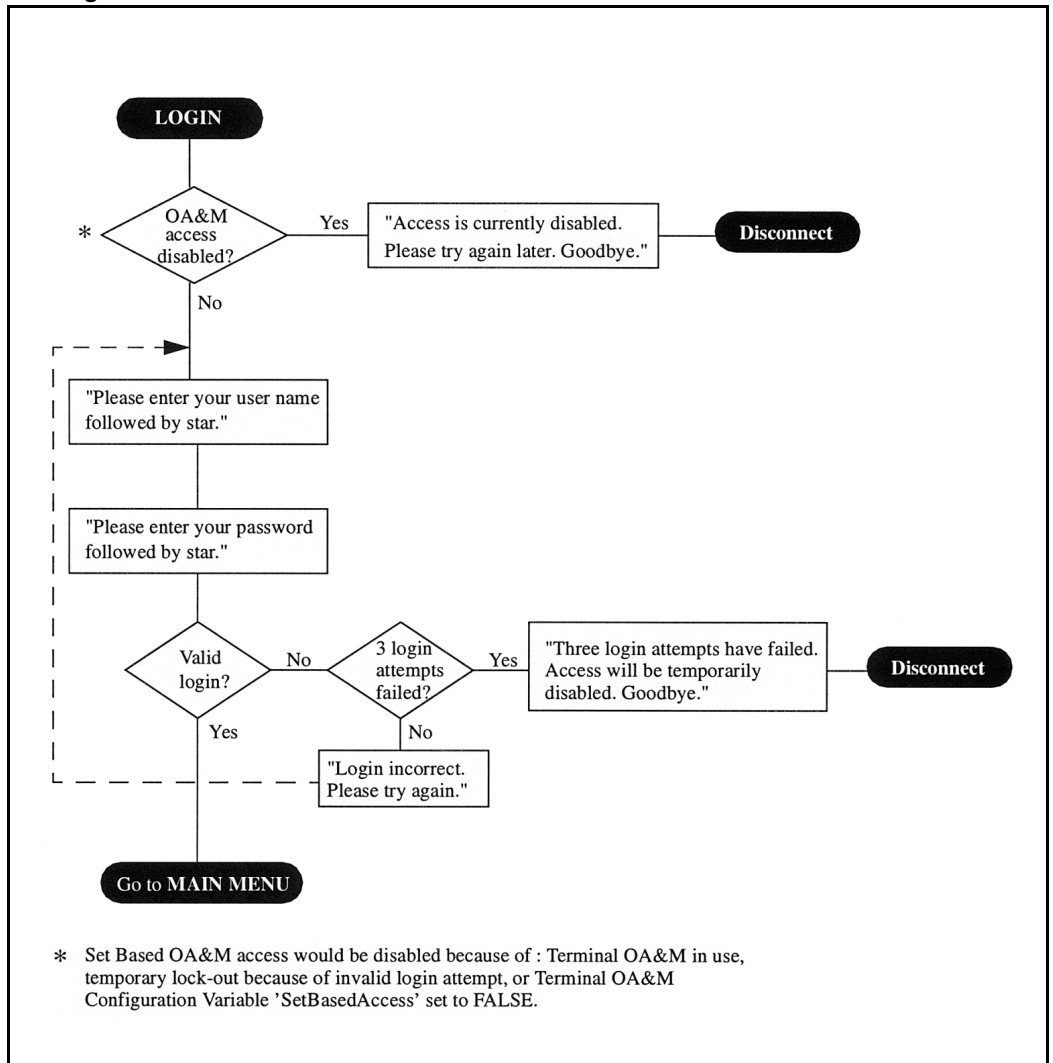
Refer to the TUI flowcharts starting on page 251 for further information on the following TUI functions:

- Login (Figure 102 on page 251)
- Main menu (Figures 103 and 103 on page 252 and page 252)
- Record menu (Figures 104 and 105 on page 254 and page 255)
- Assignment menu (Figure 106 on page 256)
- Channel Information menu (Figure 107 on page 257)
- Delete menu (Figure 108 on page 258)

### Login flowchart

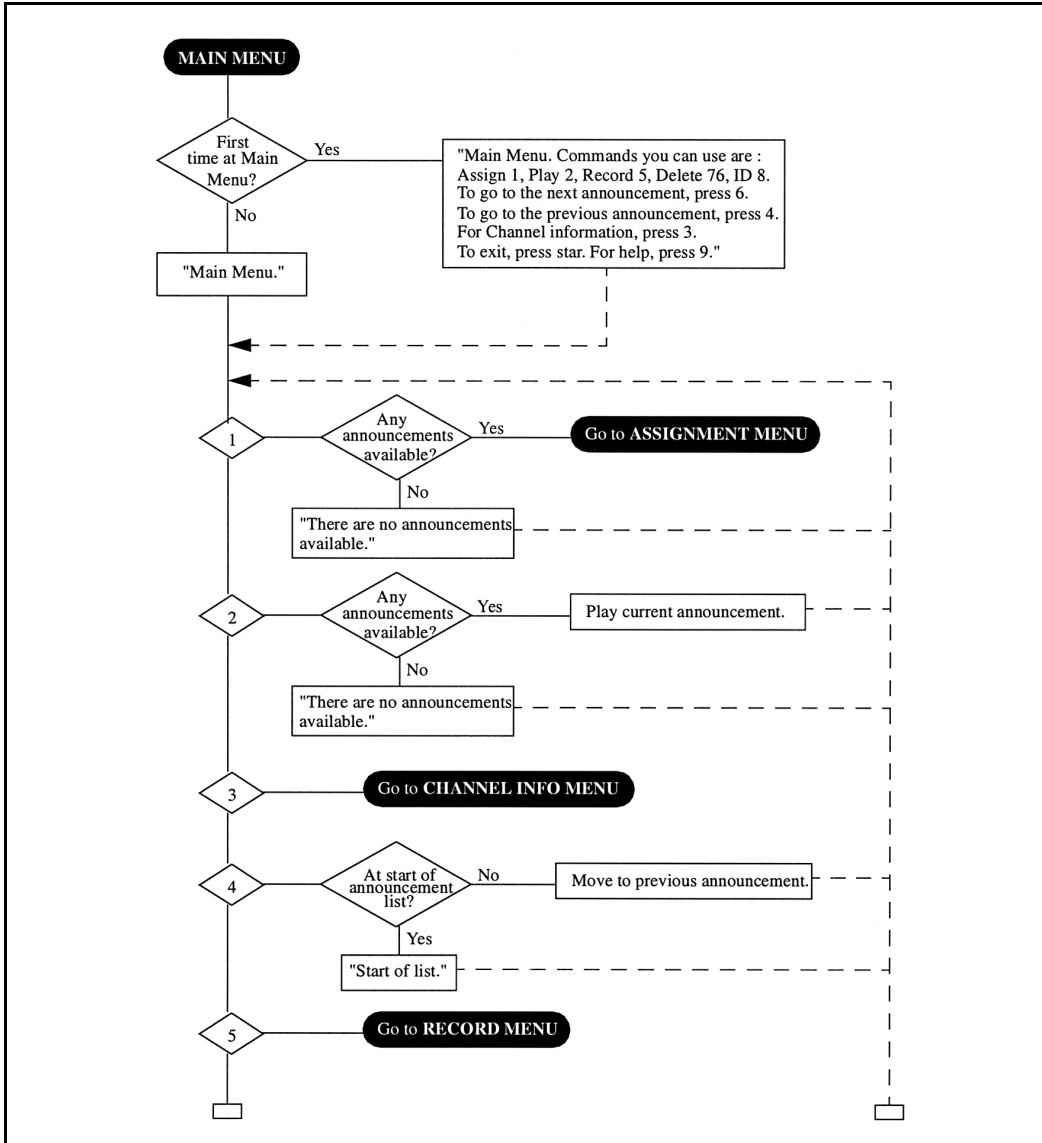
Enter the user name and password to access the MIRAN TUI.

**Figure 102**  
TUI Login flowchart

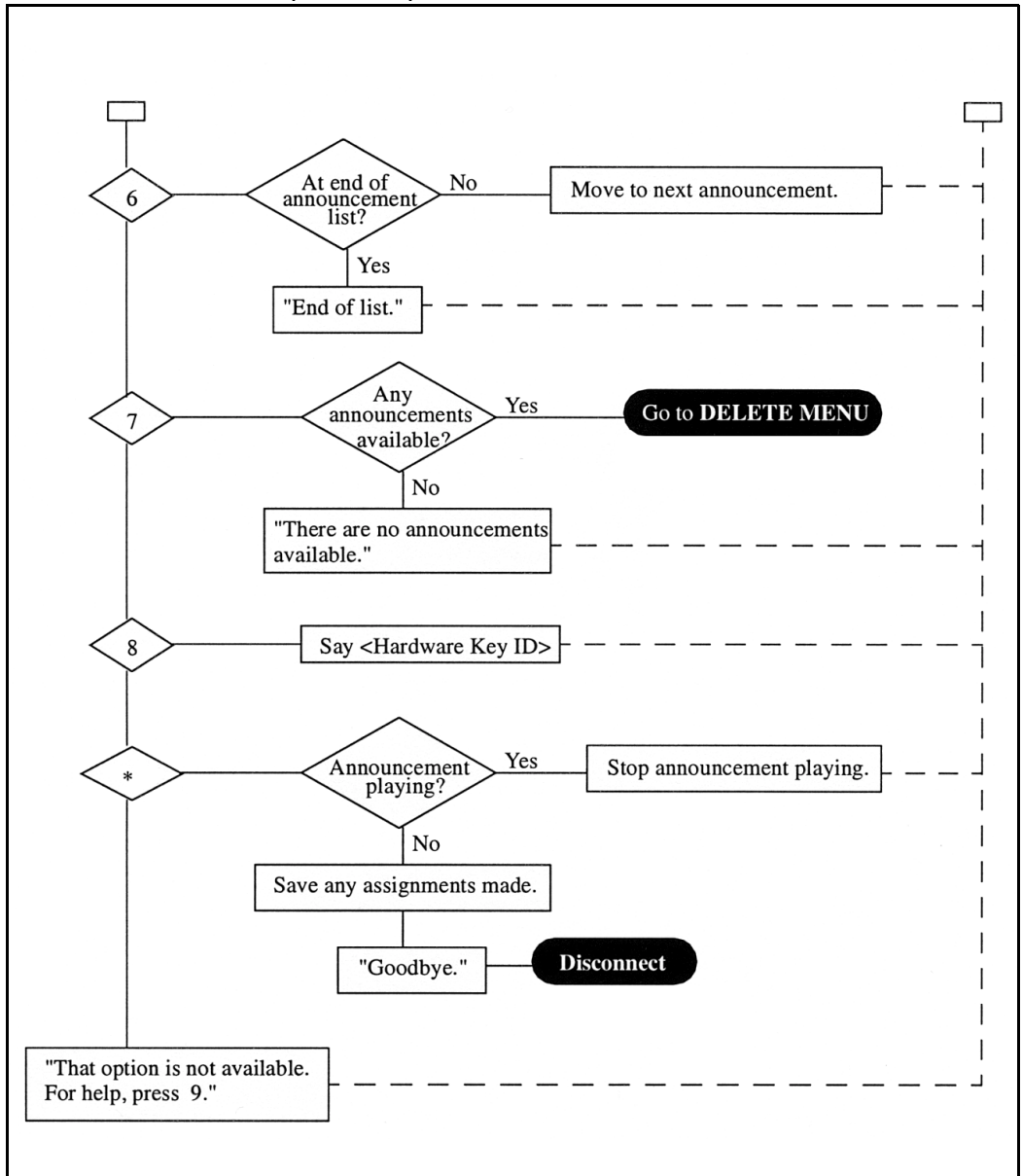


### Main menu

Figure 103  
TUI Main menu flowchart (Part 1 of 2)



TUI Main menu flowchart (Part 2 of 2)



### Record menu

Dial 5 in the Main menu to access the Record menu. This function allows announcements to be recorded.

Figure 104  
TUI Record Menu flowchart (part 1 of 2)

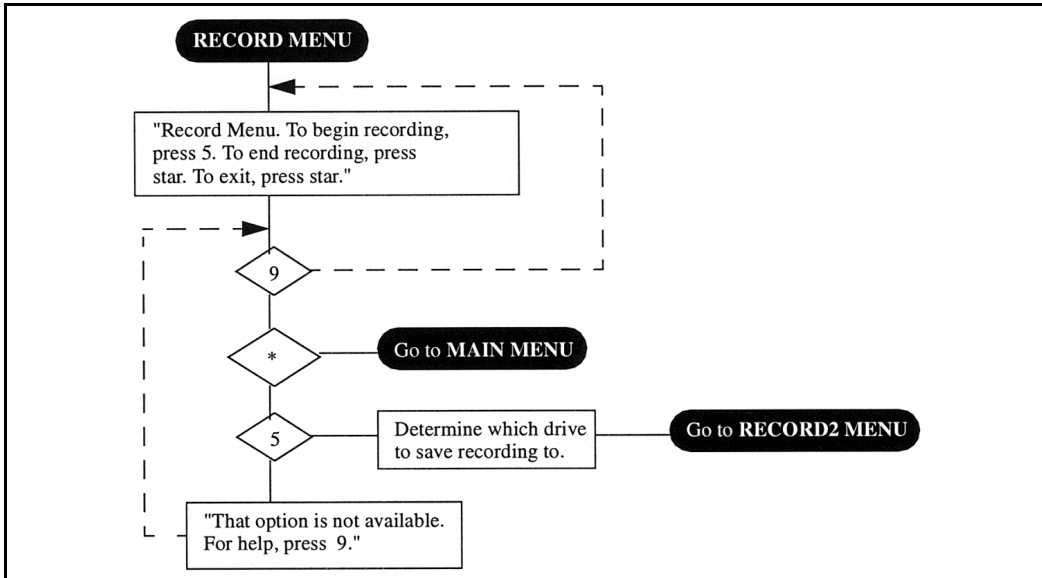
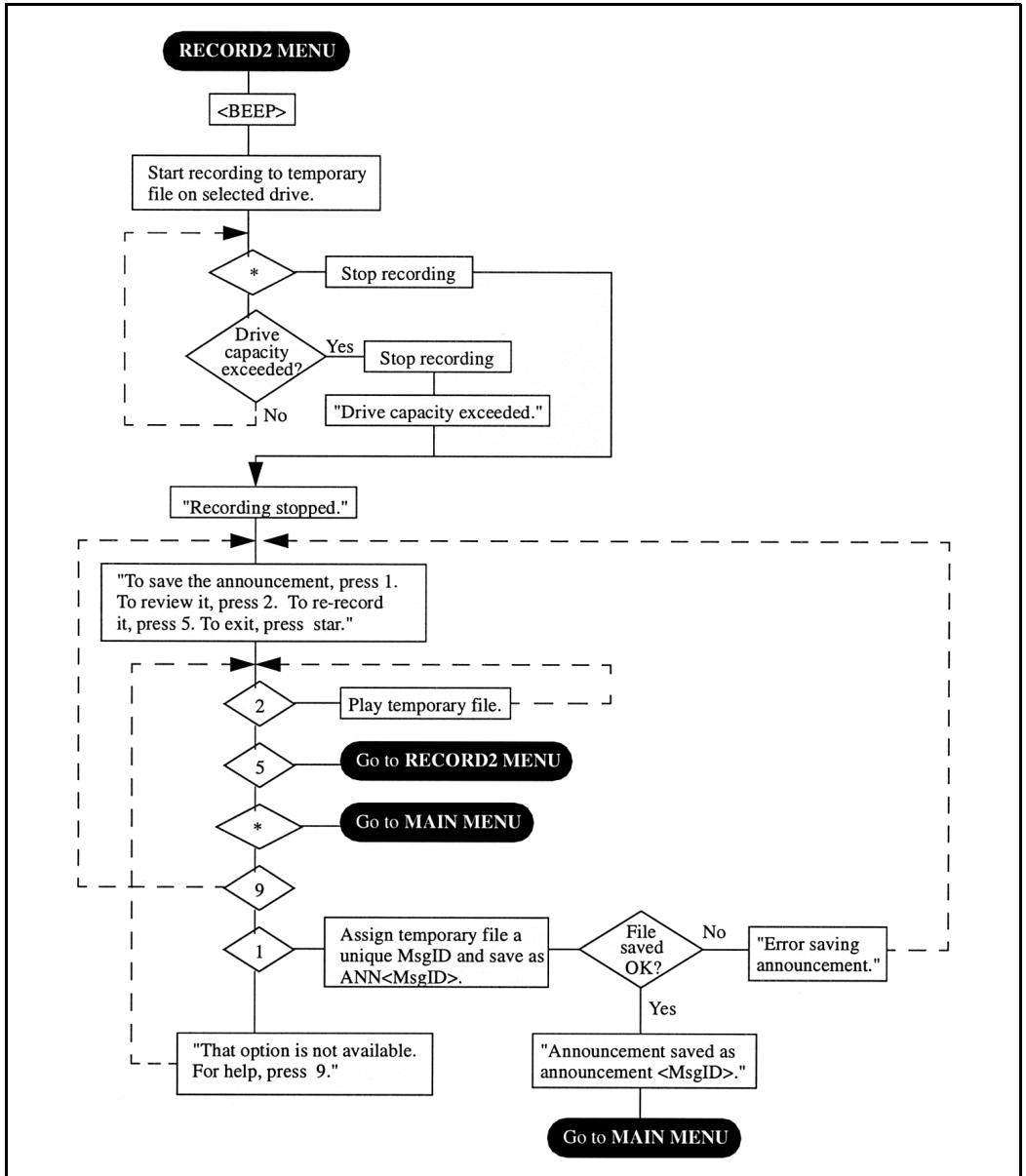


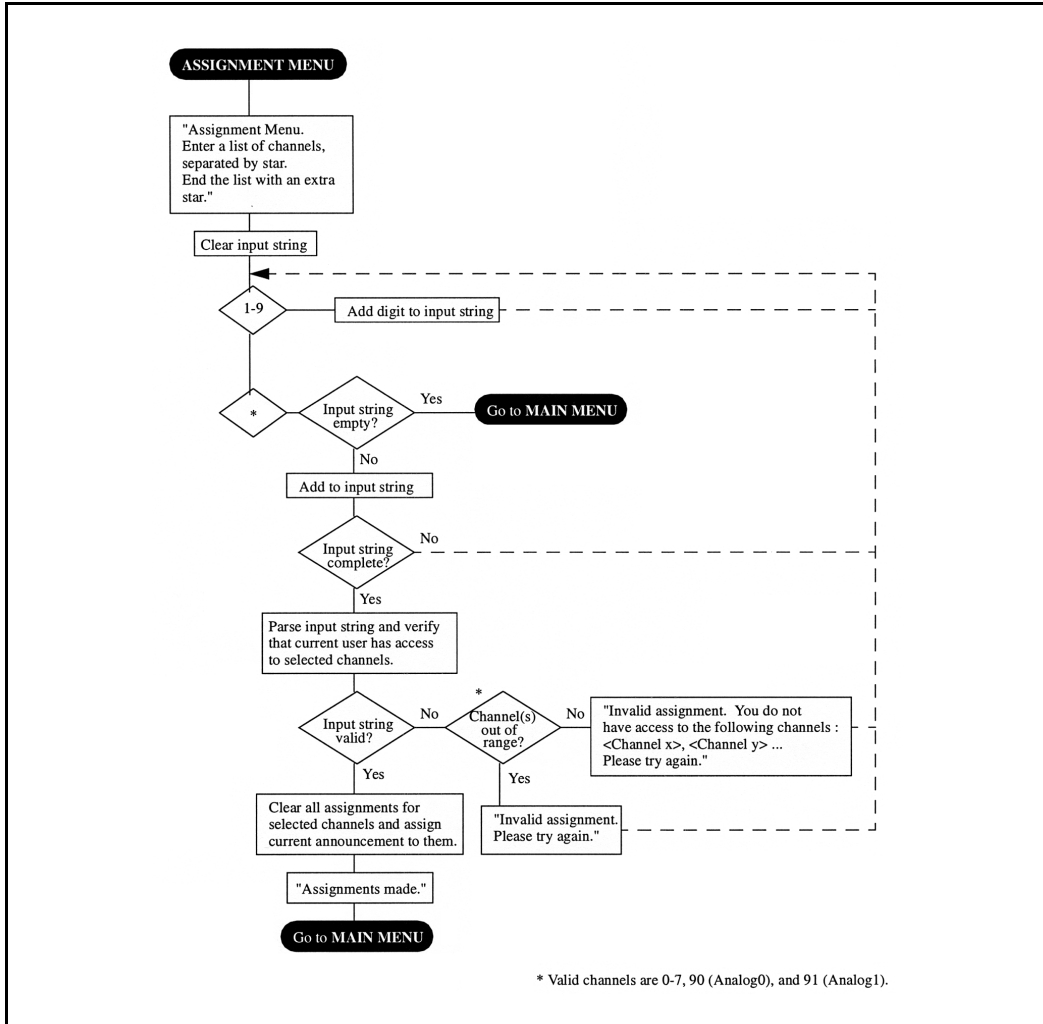
Figure 105  
TUI Record Menu flowchart (Part 2 of 2)



### Assignment Menu

Dial 1 in the Main menu to access the Announcement menu. This function allows announcements to be assigned to MIRAN III Succession Media Card channels.

Figure 106  
TUI Assignment menu flowchart

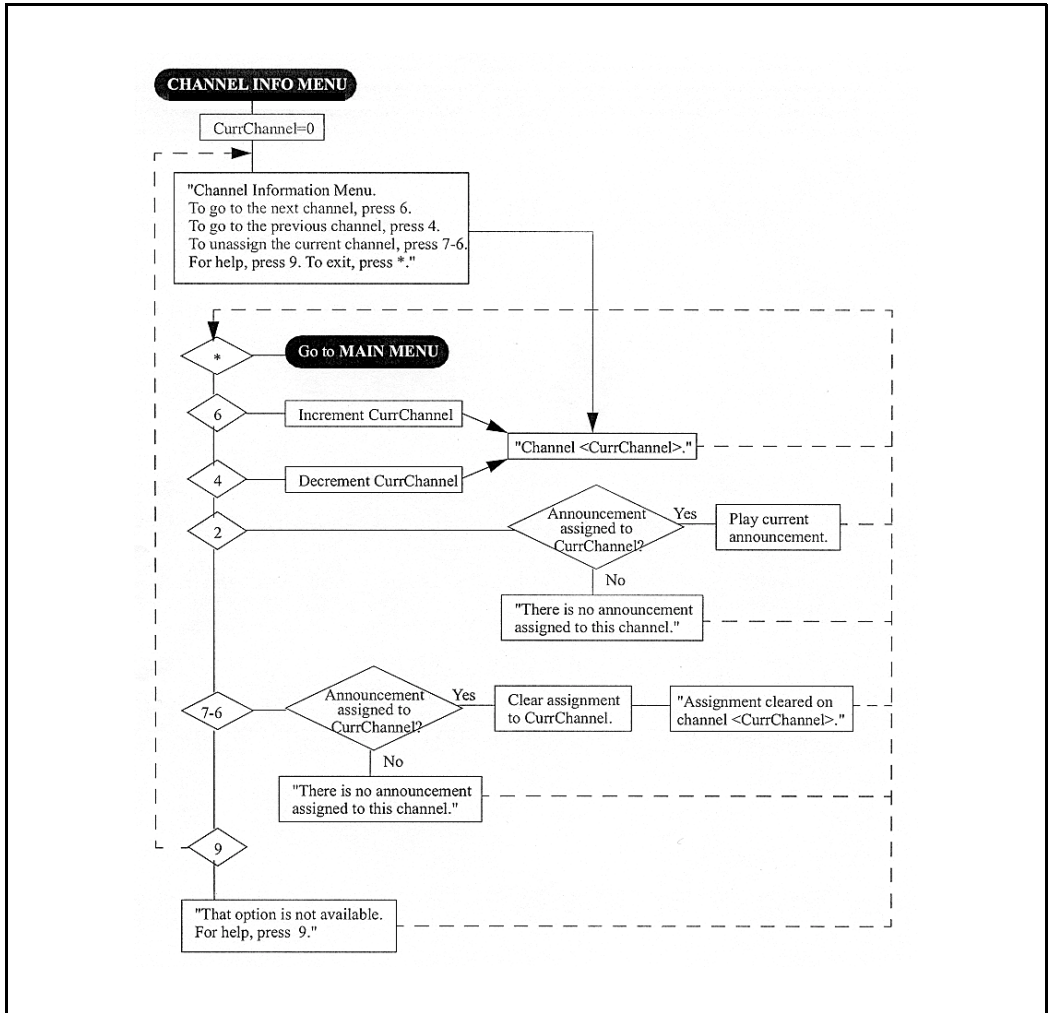




### Channel Information menu

Dial 3 at the Main menu to access the Channel Information menu. This function allows the announcement assigned to a MIRAN III Succession Media Card channel to be heard. This function also allows an announcement to be removed from a channel.

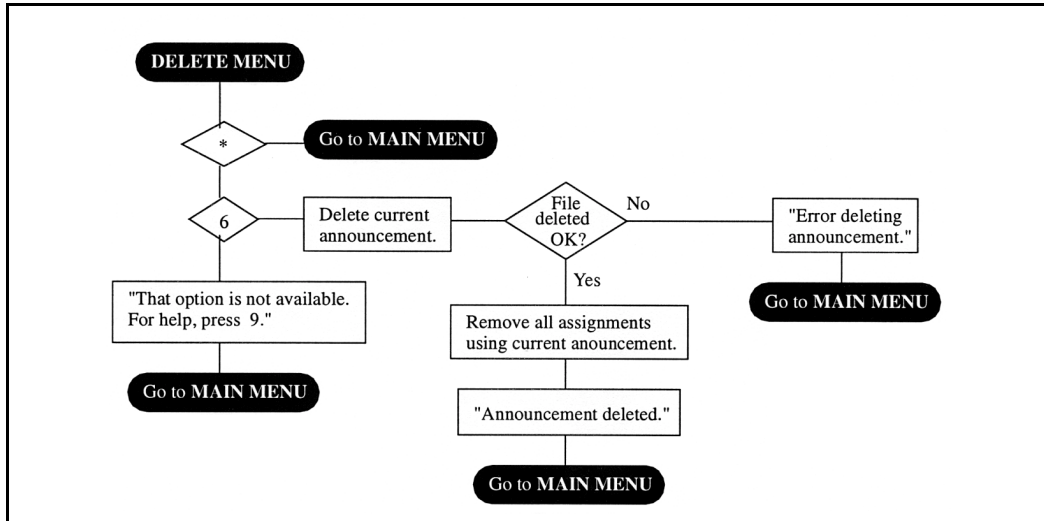
**Figure 107**  
**TUI Channel Information menu flowchart**



### Delete Menu

Dial 7 in the Main menu to access the Delete menu. This function allows the announcement to be deleted.

Figure 108  
TUI Delete menu flowchart



---

# Maintenance

---

## Contents

This section contains information on the following topics:

Maintenance overview. . . . .	260
Diagnostic tools. . . . .	260
LED indicators. . . . .	261
Display codes. . . . .	261
Overlay commands. . . . .	261
MIRAN fault isolation and correction. . . . .	262
MIRAN III fault isolation using the menu system. . . . .	265
Card replacement. . . . .	266

## Reference list

The following are the references in this section:

- *General Maintenance Information (553-3001-500)*
- *Hardware Replacement (553-3001-520)*
- *Fault Clearing (553-3001-510)*
- *Administration (553-3001-311)*
- *Hardware Replacement (553-3001-520)*

## Introduction

This chapter describes MIRAN III Succession Media Card maintenance tools and procedures to help in identifying the MIRAN III Succession Media Card faults, locating defective equipment, correcting problems by fixing or replacing defective equipment, and verifying the operation of the MIRAN III Succession Media Card after corrections or replacements have been made.

## Maintenance overview

Approach problem identification systematically. A problem can have more than one cause. To isolate the cause, a knowledge of MIRAN III Succession Media Card operation is required. Once the cause is identified, users can correct the problem by replacing the defective card, connecting accidentally disconnected cables, or correcting the software security problem.

The system and MIRAN III Succession Media Card provide built-in self-diagnostic indicators and software and hardware tools. These diagnostic facilities simplify system troubleshooting and reduce Mean-Time-To-Repair (MTTR).

This chapter focuses on the maintenance of the MIRAN equipment. It requires that the system be operating correctly before starting a diagnosis of the MIRAN III Succession Media Card problems.

The system installation and maintenance guide documents: *General Maintenance Information* (553-3001-500), *Fault Clearing* (553-3001-510), and *Hardware Replacement* (553-3001-520) describe how to maintain the entire system. This chapter describes how to maintain the MIRAN III Succession Media Card as an integral part of the system.

## Diagnostic tools

Diagnostic tools are used to troubleshoot problems in the system including problems with MIRAN III Succession Media Card. When diagnosing MIRAN III Succession Media Card problems, more than one of these tools can be used.

System diagnostic tools consist of:

- LED indicators
- display codes
- card self-tests
- sanity monitoring
- overlay commands

## LED indicators

System cards are equipped with red LED indicators and module power supplies are equipped with green LED indicators. These indicators show the status of each card or power supply.

### MIRAN maintenance LED indicator

The MIRAN III Succession Media Card has a red card LED indicator at the top of the faceplate. It indicates the status of the card. If the LED is on, the card can be faulty or disabled. The LED turns off when the card is software enabled.

## Display codes

The MIRAN III Succession Media Card is equipped with a four-digit alphanumeric hexadecimal display on the faceplate.

The hexadecimal display indicates the progress of the internal self-test in the form of T:xx. Refer to “Succession Media Card hexadecimal codes” on page 271. Upon successful completion of the test and the start-up of the RAN application, it will display the code “MRN3”.

The maintenance display on the MIRAN III Succession Media Card faceplate provides detailed maintenance information. The display includes the following types of information:

- self-test results on power-up
- maintenance routine results
- upgrade and backup information
- reading and writing to and from A: and C: drives.

## Overlay commands

Diagnostics are performed for every card as part of the daily routines. It can be invoked from a maintenance TTY. See *Hardware Replacement* (553-3001-520).

The Succession Media Card appears as an Enhanced Extended Universal Trunk (EXUT) card to a system in which it is installed. All relevant system maintenance commands for an EXUT card can, therefore, be used with the Succession Media Card. Use Overlay 32, the Network and Peripheral Equipment Diagnostics program, to enable and disable RAN channels. To test the music and RAN device, use Overlay 36, the Trunk Diagnostics program.

Table 4 on page 262 lists some of the commands used to control the MIRAN status and functions.

**Table 4**  
**Commands to enable/disable and test the Succession Media Card channels**

Overlay	Command	Operation performed
32	DISC / ENLC	Disables/Enables specified card.
32	DISU / ENLU	Disables/Enables specified channel.
36	RAN	Tests RAN device for specified customer and route.
32	STAT	Gets status of specified card/channel.

All of the above commands are handled by the Succession Media Card exactly as they are by the EXUT card, transparently to the system.

## MIRAN fault isolation and correction

Fault clearing procedures for MIRAN III Succession Media Card are the same as for other IPE cards. Refer to *Fault Clearing (553-3001-510)* for more information.

Table 5 on page 263 deals specifically with MIRAN III Succession Media Card service problems. To diagnose these problems, the table refers to the test procedures in this manual that will most likely fix these problems, based on the symptoms.

**Table 5**  
**MIRAN equipment problems**

Symptoms	Diagnosis	Solution
Red card LED on the MIRAN III Succession Media Card is permanently on.	Card is disabled or faulty.	Go to <i>Procedure 77</i> to check the card status and perform the self-test.
Display on the Succession Media Card shows fault codes.	Card faulty, failed self-test or problem communicating with peripheral equipment.	Go to <i>Procedures 77</i> and <i>2</i> to check self-test and self-test on reset. Also refer to Hex Codes in Appendix A for a list of error codes. Based on the maintenance display codes description, take the appropriate action and resolve the problem.
Error messages printed on the terminal or the Meridian 1 TTY.	Hardware or software problems with the MIRAN III Succession Media Card.	Note various error messages. Refer to <i>System Messages (553-3001-411)</i> for a list of these messages and their description. Based on the code's description, take the appropriate action to resolve the problem.

If the problem cannot be resolved after using all available diagnostic tools and test procedures, make a list of all the symptoms observed, and contact the field service representative. Refer to Appendix A “Sound recording, codes, and interfaces” on page 269 to identify the HEX codes that indicate possible problems with MIRAN III Succession Media Card.

To self-test MIRAN III Succession Media Card, follow the steps in Procedure 77:

**Procedure 77**  
**MIRAN III Succession Media Card self-test steps**

- 1 The card self-tests.
- 2 The Card LAN polls the card.
- 3 If the self-test passed, the card sends back “powered-up occurred” message.
- 4 The Card LAN requests configuration data.
- 5 The card returns configuration data (card type, A07 signaling type, and TN mapping type 2).
- 6 The Card LAN enables the DS-30X signaling channel.

- 7 The Succession Media Card waits until it receives configuration data (such as, trunk type, signaling type, and balance impedance) through the DX-30X, but then discards this data.
- 8 The card goes into its main program loop.

————— *End of Procedure* —————

To reset the Succession Media Card command, follow the steps in Procedure 78:

**Procedure 78**

**Reset Succession Media Card command**

- 1 The Software sends a reset message to the card if no channels are busy.
- 2 The card sets all appropriate resources to disabled state and turns on the faceplate LED.
- 3 The Succession Media Card resets and self-tests. Self-test results are stored in case a later query is performed by the Meridian 1 and Succession CSE 1000. Refer to Table 6 on page 271.
- 4 The Card LAN polls the card.
- 5 If the self-test passes, the card sends back a message: “power-up occurred”.
- 6 Card LAN requests configuration data.
- 7 The card returns configuration data (card type, A07 signaling type, and TN mapping type 2) and enable DS-30X link.
- 8 Card LAN enables the DS-30X signaling channel
- 9 The card waits until it receives download configuration data (such as, trunk type, signaling type, and balance impedance) through the DS-30X, but then discards this data.
- 10 The card goes to its main program loop.

————— *End of Procedure* —————



## MIRAN III fault isolation using the menu system

Refer to “RAN Application: Text-based User Interface” on page 153 for details on using the menu system. The Main Menu is seen when accessing the text-based OA&M. Each option listed on the Main Menu leads to another task screen or submenu.

### Main menu

Log in to the Text-based User Interface to access the Main Menu. This OA&M screen presents the highest level of end-user maintenance access and provides all functions needed to configure, maintain, and upgrade the Succession Media Card.

**Figure 109**  
**Main Screen Menu**



```
[10025088]           - Main Menu -           [Admin]

 1  MIRAN Administration...
 2  Pack Administration...
 3  Maintenance & Diagnostics...
 4  User Administration...

 9  Log Off...

Choose a Menu Option or 9 to Exit :
Miran3>_
```

### Maintenance & Diagnostics menu

To troubleshoot the MIRAN III using the menu system, select **3** in the Main Menu and press the Enter key to display the Maintenance and Diagnostics submenu.

**Figure 110**  
**Maintenance and Diagnostics menu**

```
[10025088]          - Maintenance & Diagnostics -          [Admin]
1 System Information
2 Cold Reboot
3 Command Line Access (Host)

9 Back to previous Menu...

Choose a Menu Option or 9 to Exit :
Miran3>_
```

## Card replacement

The Succession Media Card is based on Flash EPROM technology. This allows the Succession Media Card to be removed from the card slot indefinitely without losing the configuration data.

To replace the MIRAN III Succession Media Card, follow the steps in Procedure 79:

### Procedure 79

#### Replace the Succession Media Card

- 1 Disable the Succession Media Card by loading Overlay 32 and executing the **DISC l s c** command (**l**= loop, **s**= shelf or module, **c**= card in the module).
- 2 Remove the card from the card slot.
- 3 Remove all PC Cards from the faulty MIRAN III Succession Media Card – the internal PC Card and the PC Cards installed in the MIRAN III Succession Media Card faceplate slots.
- 4 Transfer the Security Device from the faulty MIRAN III Succession Media Card to the replacement.

- 5 Transfer all PC Cards to the new MIRAN III Succession Media Card.  
**Note:** This procedure moves all software, configuration, and records to the replacement MIRAN III Succession Media Card.
- 6 Install the new MIRAN III Succession Media Card into the IPE module card slot.
- 7 Enter the same keycode to enable the new MIRAN III Succession Media Card.
- 8 Enable the new card by executing the **ENLC I s c** command.
- 9 Configure the newly installed MIRAN III Succession Media Card.
- 10 Package the faulty MIRAN III Succession Media Card and ship it to the repair center.

---

*End of Procedure*

---



---

# Appendix A: Sound recording, codes, and interfaces

---

## Contents

This section contains information on the following topics:

Sound recording configuration. . . . .	269
Succession Media Card hexadecimal codes. . . . .	271
MIRAN III Succession Media Card interface connectors. . . . .	272
Maintenance Serial Port. . . . .	272
Analog port and pinouts. . . . .	275
I/O panel to modem cable. . . . .	276
I/O panel to modem cable. . . . .	276
Modem setup. . . . .	276

## Introduction

This appendix describes a typical sound recording configuration, lists the MIRAN III Succession Media Card hexadecimal codes that are displayed on the four-digit display on the Succession Media Card faceplate, and describes the external connectors and their pin assignments. The hex codes provides the status of the card during power-up and on the operational status when in service.

## Sound recording configuration

The following is an example of a PC-based digital sound recording. Alternate configurations can be used that produce the 8 kHz A-law or U-law PCM format output files required by MIRAN III either in .ULW or .WAV format.

Minimum PC requirements:

- 100 MHz Pentium processor
- 32 Mbytes of RAM
- 1 Gbyte hard drive
- x4 CD-ROM
- Windows 95
- speakers

Recommended sound card:

- Creative Labs AWE 32 Plug and Play audio card Model CT3601 (comes with the microphone)

PC drive:

- DATABOOK ThinCard Drive Model TMB-240

Software:

- GoldWave sound editor.

*Note:* When recording announcements, use the following recommendations. To remove sharp transitions at the boundaries of an announcement, add fade-in (from 0) at the start of the announcement and fade-out (to 0) at the end of announcement. Users must add one second of silence to the beginning and to the end of each announcement.

When the internal RAM test, ALU test, address mode test, boot ROM test, timer test, or external RAM test fails, the MIRAN III Succession Media Card goes into a maintenance loop and no further processing is possible. A failure message is displayed to indicate which test failed. For example, the message changes to **F:xx** if the timer test fails (F:05 is displayed).

## Succession Media Card hexadecimal codes

**Table 6**  
**Succession Media Card hexadecimal codes**

<b>Codes</b>	<b>Description</b>
T:00	Initialization
T:01	Testing internal RAM
T:02	Testing ALU
T:03	Testing address modes
T:04	Testing watchdog
T:05	Testing 8051 co-processor
T:06	Testing timers
T:07	Testing external RAM
T:08	Testing dongle
T:09	Programming time switch FPGA
T:10	Programming ISPDI FPGA
T:11	Testing host dual-port RAM
T:12	Testing DS-30 dual-port RAM
T:13	Testing SEEPROM
T:14	Boosting Host Processor, waiting for response with self-test information
T:15	Reserved for future use
T:16	Reserved for future use
T:17	Reserved for future use
T:18	Reserved for future use
T:19	Reserved for future use

**Table 6**  
**Succession Media Card hexadecimal codes (Continued)**

<b>Codes</b>	<b>Description</b>
T:20	Waiting for application start-up message from Host Processor
T:21	CardLAN enabled, waiting for request configuration message
T:22	CardLAN operational, A07 enabled, display now under host control MRN3 Succession Media Card is operational

## **MIRAN III Succession Media Card interface connectors**

The interface connectors connect the MIRAN III Succession Media Card to the external equipment at the faceplate and the Audio-adaptor.

### **Maintenance Serial Port**

For occasional OA&M purposes, a serial port is provided on the MIRAN III Succession Media Card faceplate, through an 8-pin mini DIN connector. For a permanently connected terminal, the Maintenance Serial port is duplicated on the Audio-adaptor.



Table 7 on page 273 displays pinouts for the MIRAN III Succession Media Card faceplate 8-pin mini-DIN connector.

**Table 7**  
**Faceplate 8-pin mini-DIN connector signals**

<b>Pin No.</b>	<b>Signal</b>	<b>Description</b>
1	BDTRB-	Port B Data Terminal Ready
2	BSOUTB-	Port B Serial Data Out
3	BSINA-	Port B Serial Data In
4	SGRD	Signal Ground
5	BSINA-	Port A Serial Data In
6	BCTSA-	Port A Clear To Send
7	BSOUTA-	Port A Serial Data Out
8	BDTRA-	Port A Data Terminal Ready

Table 8 on page 274 lists the port A and port B connections at the I/O panel 50-pin connector. It lists the pins signal assignments, wire color code, and the description of the signals. Total distance from the MIRAN III Succession Media Card to the MDF and from the MDF to the terminal must not exceed 50 feet.

**Table 8**  
**Port A and port B pinout and wire color code on the 50-pin connector**

<b>I/O Panel 50-pin connector pin assignment and wire color code</b>	<b>MIRAN signal name</b>	<b>MIRAN signal description</b>
16 (BL-Y)	Reserved	Future use
41 (Y-BL)	BDCDA-	Port A Data Carrier Detect
17 (O-Y)	BSINA-	Port A Serial Data In
42 (Y-O)	BSOUTA-	Port A Serial Data Out
18 (G-Y)	BDTRA-	Port A Data Terminal Ready
43 (Y-G)	SGRD	Signal Ground
19 (BR-Y)	BDSRA-	Port A Data Set Ready
44 (Y-BR)	BRTSA-	Port A Request to Send
20 (s-y)	BCTSA-	Port A Clear to Send
45 (Y-S)	BSINB-	Port B Serial Data In
21 (BL-V)	BSOUTB-	Port B Serial Data Out
46 (V-BL)	BDCDB-	Port B Data Carrier Detect
22 (O-V)	BDTRB-	Port B Data Terminal Ready
47 (V-O)	BDSRB-	Port B Data Set Ready

## Analog port and pinouts

Table 9 on page 275 lists the 50-pin I/O panel connector pins and their signal assignment for the analog port.

The 3.5 mm audio jack provides access to a single analog input (ANALOG0). It is used to connect external analog sources, such as a tape recorder or CD player, in order to record to file or to route it directly through a trunk emulation port into Meridian 1 and Succession CSE 1000 for MOH.

The audio jack provides an external connection to Port ANALOG0 for a short term connection of an external analog source

**Table 9**  
**Analog port backplane signals.**

I/O Panel 50-pin connector pin assignment and wire color code	MIRAN III Succession Media Card signal name	MIRAN III Succession Media Card signal description
5 (S-W)	AGND	Analog Ground
30 (W-S)	AGND	Analog Ground
7 (O-R)	AIN0	Analog In, Port 0
32 (R-O)	AIN1	Analog In, Port 1
9 (BR-R)	AGND	Analog Ground
34 (R-BR)	AGND	Analog Ground

**Note:** Cross-connect audio pairs can be used to connect to external recording devices for the purpose of backing up announcements to a tape.

## I/O panel to modem cable

Table 10 on page 276 shows the I/O panel to modem cable pin assignments

**Table 10**  
**I/O panel connector to modem cable pinouts**

Signal name	50-pin I/O panel parallel connector Pin No.	25-pin male (RS-232) (Modem side) Pin No.
TX	21	2
RX	45	3
DTR	22	20
GRN	43	7

## Modem setup

To setup the modem, use a terminal connected to the modem. Set up the terminal for 9600 bps, 8 bits, 1 start, 1 stop, and no parity.

- 1 Setting the modem to auto answer
  - Connect the terminal to the modem
  - Type "AT" for a Hayes compatible modem. If the modem is connected properly, it will reply "OK".
  - Type "ATS0=1"
  - Type "AT&W0" to save the settings.
  
- 2 Disable result codes.
  - Type "AT" for a Hayes compatible modem. If the modem is connected properly, it will reply "OK".
  - Type "ATQ1"
  - Type "AT&W0" to save the settings.
  
- 3 Connect the modem to the MIRAN III Succession Media Card using one of the cable configuration tabulated above.

---

# Appendix B: Environmental and electrical regulatory data

---

## Contents

This section contains information on the following topics:

Environmental specifications. . . . .	277
Electrical regulatory standards. . . . .	279
Electro-Magnetic Compatibility (EMC). . . . .	280

## Introduction

This chapter presents information about the MIRAN III Succession Media Card reliability, environmental specifications, and electrical regulatory standards.

## Environmental specifications

This section describes the operating and storage temperature ranges and humidity for the MIRAN III Succession Media Card. The ideal operating temperature is obtained when the environmental temperature is regulated using air-conditioning, however the MIRAN III Succession Media Card is design to operate in the standard telephony equipment accepted temperature and humidity ranges.

Table 11 on page 278 displays measurements of performance under test conditions of temperature and shock.

**Table 11**  
**Temperature-related specifications**

Specification	Minimum	Maximum
<b><i>Normal Operation</i></b>		
Recommended	15° C	30° C
Relative humidity	10%	55% (non-condensing)
Absolute (less than 72 hours)	0° C	45° C
Relative humidity	5% ---- 95% (non-condensing)	
Rate of change	Less than 1° C for each 3 minutes	
<b><i>Storage</i></b>		
Recommended	-50° C	+70° C
Relative humidity	0%	95% (non-condensing)
<b><i>Temperature Shock</i></b>		
In 3 minutes	-50° C	25° C
In 3 minutes	70° C	25° C
	-40° to 70° C (non-condensing)	

## Electrical regulatory standards

Table 12 on page 279 to Table 14 on page 281 list the safety and electro-magnetic compatibility regulatory standards for the MIRAN III Succession Media Card, listed by geographic region. Specifications for the MIRAN III Succession Media Card meet or exceed the standards listed in these regulations.

Table 12 on page 279 provides a list of safety regulations met by the MIRAN III Media Card in any Meridian 1 or Succession CSE 1000 system, along with the type of regulation and the country/region covered by each regulation.

**Table 12**  
**Safety regulations.**

Regulation Identifier	Regulatory Agency
c(CSA)us 950	Safety of Canada, UL 1950 Safety, United States, CALA
EN 60950	Safety Europe
AS3260, TS001	Safety Australia
JATE Network/Safety	Japan
IEC 60950-CB	report including country deviations

## Electro-Magnetic Compatibility (EMC)

Table 13 on page 280 lists electro-magnetic emissions regulations met by the MIRAN III Succession Media Card, along with the country's standard that lists each regulation.

There are no limitations on the number of Succession Media Cards that can be installed in any Meridian 1 or Succession CSE 1000 system, with one exception: the number of Succession Media Cards that can be installed in an IPE module (large system) for Class B compliance (EN55022:1998 and EN55024:1998) is limited to four. There are no limitations for Class A installations.

**Table 13**  
**Electro-Magnetic Emissions**

Regulation Identifier	Regulatory Agency
FCC part 15 Class A	United States Radiated Emissions
CSA C108.8	Canada Radiated Emission
EN50081-1	European Community Generic Emission Standard
EN55022/CISPR 22 CLASS B	Radiated Emission (Basic Std.)
BAKOM SR 784.103.12/4.1/1	EMC/Safety (Switzerland)
SS-447-20-22	Sweden EMC Standard
AS/NZS 3548	EMC (Australia/New Zealand)
NFC 98020	France EMC Standard



Table 14 on page 281 lists electro-magnetic immunity regulations met by the MIRAN III Succession Media Card, along with the country's standard that lists each regulation.

**Table 14**  
**Electro-Magnetic Immunity.**

<b>Regulation Identifier</b>	<b>Regulatory Agency</b>
CISPR 22 Sec. 20	Class B I/O conducted noise
IEC 801-2 (level 4)	ESD (Basic Standard)
IEC 801-3 (level 2)	Radiated Immunity (Basic Standard)
IEC 801-4 (level 3)	Fast transient/Burst Immunity (Basic Standard)
IEC 801-5 (level 4, preliminary)	Surge Immunity (Basic Standard)
IEC 801-6 (preliminary)	Conducted Disturbances (Basic Standard)
BAKOM SR 784.103.12/4.1/1	EMC/Safety (Switzerland)
SS-447-20-22	Sweden EMC Standard
AS/NZS 35481	EMC (Australia/New Zealand)
NFC 98020	France EMC Standard

**Table 15**  
**Electro-magnetic immunity**

<b>Regulation Identifier</b>	<b>Regulatory Agency</b>
EN55024 Class	B I/O conducted noise
EN61000-4-2 (level 4)	ESD (Basic Standard)
EN61000-4-3 (level 2)	Radiated Immunity (Basic Standard)
EN61000-4-2 (level 3)	Fast transient/Burst Immunity (Basic Standard)
EN61000-4-5 (level 4, preliminary)	Surge Immunity (Basic Standard)
EN61000-4-6 (preliminary)	Conducted Disturbances (Basic Standard)
EN6100-4-11	Dips, Interruptions (system level)
EN61000-3-2	Harmonics and Flickers (system level)

---

## Appendix C: NT8D37 cable connections

---

### Contents

This section contains information on the following topics:

NT8D37 cable connections .....	283
Tools list. ....	285
NT8D81BA cable removal procedure.....	286
NT8D81BA cable installation procedure .....	286

### NT8D37 cable connections

Cables are designated by the letter of the I/O panel cutout (such as, A, B, and C) where the 50-pin cable connector is attached. Each cable has three 20-pin connectors (16 positions are used) designated 1, 2 and 3, that attach to the backplane.

Using the designations given for the connectors, the backplane ends of the first cable are referred to as A-1, A-2, and A-3. Locations of the cable connectors on the backplane are designated by the slot number (L0 through L9 for NT8D11; L0 through L15 for NT8D37) and the shroud row. Using these designations, the slot positions in the first slot are referred to as L0-1, L0-2, and L0-3.

In NT8D37BA and NT8D37EC (and later vintage) modules, all 16 IPE card slots support 24-pair cable connections.

In earlier vintage modules, slots 0, 4, 8, and 12 support 24-pair cable connections. This eliminates the need to rewire if the slots are free.

Table 16 on page 284 shows the cable connections from the backplane to the inside of the I/O panel.

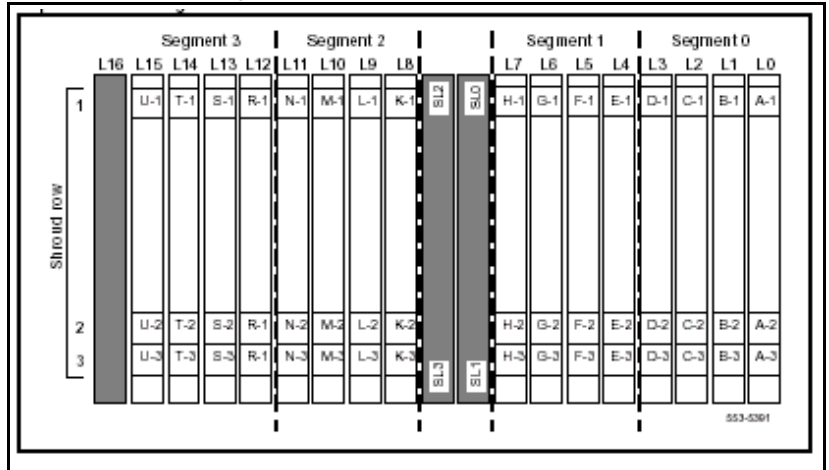
**Table 16**  
**NT8D37 cable connections**

Backplane slots – shroud rows	I/O panel/cable designation
L0-1,2,3	A
L1-1,2,3	B
L2-1,2,3	C
L3-1,2,3	D
L4-1,2,3	E
L5-1,2,3	F
L6-1,2,3	G
L7-1,2,3	H
L8-1,2,3	K
L9-1,2,3	L
L10-1,2,3	M
L11-1,2,3	N
L12-1,2,3	R
L13-1,2,3	S
L14-1,2,3	T
L15-1,2,3	U

Figure 111 on page 285 shows the following:

- the designations for the backplane end of the cables
- the backplane slot designations for the cable connections
- the associated network segments for the backplane slots

**Figure 111**  
**Backplane slot designations**



## Tools list

The following tools are required:

- Tie-wrap cutter
- Tie-wraps
- Needle nose pliers
- Slotted screwdriver

## NT8D81BA cable removal procedure

To remove the NT8D81BA cable, follow the steps in Procedure 80:

### Procedure 80

#### Removing NT8D81BA cable

- 1 Identify the I/O panel and backplane designation that corresponds to the slot in which the Succession Media Card is installed.
- 2 Power down the IPE shelf.
- 3 Remove the IPE module I/O safety panel.
- 4 Remove the ribbon cables from the IPE backplane:
  - Apply gentle pressure on the tab on the right side of the shroud until the connector pulls free from the shroud.
  - First, remove connector 1. Then remove connectors 2 and 3.

————— *End of Procedure* —————

## NT8D81BA cable installation procedure

To install the NT8D81Ba cable, follow the steps in Procedure 79:

### Procedure 81

#### Installing NT8D81BA cable

- 1 Install the NT8D81BA ribbon cable connectors in the IPE module backplane. Install the connector so that the label is facing to the right with the arrow pointing up.
  - Install connector 1 (labelled UP1^A) into backplane shroud 1.
  - Install connector 2 (labelled UP2^A) into backplane shroud 2.
  - Install connector 3 (labelled UP3^A) into backplane shroud 3.
- 2 Dress ribbon cables back individually inside the rear of the IPE module, and restore the original arrangement. Start with the cables that are going to be underneath.
- 3 Attach the NT8D81BA 50-pin connector to the IPE filter using bail clips.
- 4 Restore power to the IPE module.
- 5 Replace the I/O safety panel.

————— *End of Procedure* —————

## List of terms

---

### **ALU**

Arithmetic Logic Unit.

### **API**

Application Programming Interface. High level language software used as components in the development of an application. Also, graphics routines that perform basic graphics tasks or other functions when called by high-level application programs.

### **ASIC**

Application-Specific Integrated Circuit. A microprocessor chip designed to do specific tasks; providing graphics capability is one such task.

### **ATA**

AT Attachment interface. Normally used to refer to the PC Card version of the IDE disk drive interface found in a PC. For MIRAN III Succession Media Card, standard ATA based cards are required instead of the simpler memory based cards. The later are lower cost but require custom driver software both at the PC and the MIRAN III Succession Media Card.

### **AUI**

Autonomous/Attachment User Interface. Refers to the 15-pin, D-type connector and cables used to connect single- and multiple-channel equipment in an Ethernet transceiver.

### **BIOS**

Basic Input/Output System. A set of permanently stored program outlines in buffers that allow software to interact with hardware components (e.g., keyboard) in a device-independent manner.

**bootp**

An IP protocol that allows the automatic assignment of an IP address to a client device upon bootup.

**Boundary scan**

Test methodology for integrated circuits that provides visibility and control of on-chip logic.

**BUI**

Browser User Interface. The interface a user can use to interact with the MIRAN card through the web.

**Card option**

Low-end Meridian Mail platform that is packaged in the same cabinet with the Meridian 1 Option 11C and Mini switch.

**CD-ROM**

Compact Disk Read-Only Memory.

**CE-MUX**

Common Equipment bus with MULTipleXed address and data.

**CPE**

Customer Premise Equipment. Equipment that resides on a customer's premises and is controlled by the customer as opposed to the Central Office

**CPU**

Central Processing Unit. A chip that performs logic, control, and arithmetic functions. The part of the switch that performs these functions and any others needed to carry out call processing.

**DIN**

A German Standardization Organization.

**DS-30X**

Parallel serial transmission from a superloop (XNET) card to a Controller Card in an IPE shelf.



**DRAM**

Dynamic Random Access Memory. A type of semi-conductor memory that is characterized by its high density (smaller packages for a given amount of memory). It typically has slower access time as compared with SRAM and requires external memory refresh circuitry.

**DSP**

Digital Signal Processing. A specialized computer chip that performs speedy and complex operations on digitized waveforms. Useful in processing sound and video.

**DTMF**

Dual Tone Multi-Frequency. A term describing push-button or touch-tone dialing.

**EIDE**

Enhanced IDE (*see* IDE). This feature provides a significant improvement in performance over the standard IDE; it is comparable to standard SCSI in terms of throughput.

**EMC**

Electro-Magnetic Compatibility. Refers to equipment units that are collectively performing each of their functions without causing or suffering unacceptable degradation due to electromagnetic interference from other equipment/systems in the same environment.

**EMI**

(ElectroMagnetic Interference) - Unwanted electromagnetic coupling, such as a ham radio heard on an electric organ or church music heard in hearing aids. Also known as “static”.

**EPLD**

Erasable Programmable Logic Device. An electronic device for performing logical operations that can easily be erased and reprogrammed.

**ESS**

Environmental Stress Screening

**EST**

Environmental Stress Testing.

## **EXUT**

Enhanced Extended Universal Trunk card. See *XUT*.

## **Field programmable**

A program to which changes can be made while it is installed.

## **Firmware**

Hardwired logic, software, data, and programming instructions such as that stored by threading wires through ferrite cores. May also refer to software programmed in the factory or burnt in the field, and is semipermanently stored within ROM.

## **Flash memory**

Electrically erasable memory that is non-volatile (not affected by power disruptions).

## **FPGA**

Field Programmable Gate Array.

## **FTP**

File Transfer Protocol. This is an industry standard protocol for transferring files between a server and a client on a TCP/IP network.

## **Gate array**

A circuit consisting of an array of logic gates (network nodes) aligned on a substrate (piece of silicon) in a regular pattern.

## **IDE**

Integrated Drive Electronics. A low-cost hard disk drive interface.

## **IP**

Internet Protocol.

## **IPE**

Intelligent Peripheral Equipment - A range of cards that contain micro-processors that provide off-loading of the CPU function and the flexibility to make changes to the system's parameters without revising the hardware.

**ISA**

Industry Standard Architecture. A particular type of bus architecture on an IBM-DOS motherboard.

**IVR**

Interactive Voice Response. An application that allows telephone callers to interact with a host computer through pre-recorded announcements and prompts.

**Kernel**

That part of a computer's operating system that performs basic functions like switching between tasks.

**LCA**

Logic Cell Array) - A Xilinx product that is a form of Field Programmable Gate Array. See *FPGA*.

**Loader**

A device that moves a program or data from a floppy or hard disk and stores it into a computer's RAM memory.

**MAT**

Meridian Administration Tool. A Nortel Networks Windows<sup>TM</sup> application that is available for configuring the Meridian 1 and Succession CSE 1000 PBX.

**MAU**

Media Access Unit. A device used to allow connection of the Ethernet AUI signals on MIRAN to an external LAN.

**MCF**

Succession Media Card Compressed format. The compressed file format used by MIRAN III to store prompts and royalty-free music.

**MDS**

Modular Documentation System

**MIRAN**

Meridian Integrated Recorded Announcer.

**MINT**

Message INTerrupt. This occurs when a message being transmitted receives an interrupt signal from an outside device, which must process a task of its own. Then the transmission of the original message can resume, or be resent.

**M1**

Meridian 1

**Mmail**

Meridian Mail. Nortel's proprietary voice processing platform.

**MOH**

Music On Hold. Refers to telephony equipment, supplied by a Nortel switch through one or more trunk cards, to provide recorded music or radio to each caller on hold until the called party becomes available.

**MTBF**

Mean Time Between Failure. A measure of reliability: the time that a user may reasonably expect a device or system to work before an incapacitating fault occurs. Also, the average number of hours between one random failure and the next under stated conditions.

**MTTR**

Mean Time To Repair. The average time required for corrective maintenance.

**NTP**

Nortel Networks Publications; customer documentation. Each NTP is identified by a unique ten-digit publication number.

**OA&M**

Operations, Administration, and Maintenance.

**OEM**

Original Equipment Manufacturers.

**OTM**

**PAS**

Product Administration System.

**PBX**

Private Branch eXchange. A telephony switch that is privately owned.

**PCB**

Printed Circuit Board.

**PCI**

Peripheral Component Interconnect. An Intel device that enables high performance in an interface between a CPU bus and a peripheral device. A high-speed PC local expansion bus, capable of interconnecting ICs and plug-in boards to the host processor.

**PCM**

Pulse Code Modulation. A method for encoding an analog voice signal into a digital bit stream.

**PCMCIA**

Personal Computer Memory Card International Association (PC Card). This organization has defined a credit card sized plug-in board for use in PCs. These cards are the only way to get to a laptop bus without using a docking station. In addition, application software can be stored on the card into system address space so that the software can run directly from the card, resulting in a faster start and less memory required from the host computer.

**PDF**

Portable Document Format.

**RAN**

Recorded ANnouncement trunks - A trunk that provides a link between the PBX and a recorded announcement device, used to provide recorded information to callers.

**RTC**

Real Time Clock. System clocking influenced/determined by connection to a time process external to processing by the system.

## **SBC**

Sub-Band Coding. Algorithm used by Meridian Mail for compressing speech data down to just over a quarter of its original size.

## **Scalable architecture**

A way of designing a system that allows it to be resized with relative ease; the cost required to increase its size in proportion to the new size.

## **SDI**

Serial Data Interface. For some Meridian PBXs, provides ports between the CPU and external devices like a teletype or maintenance telephone. More generally, an SDI is a mechanism for changing the parallel arrangement of data within computers to the serial form used on transmission lines, and vice versa.

## **SL-1**

Generic term given to Nortel Networks digital switches. Meridian 1 and Succession CSE 1000 refers specifically to the current series of Nortel PBX's.

## **STA**

Single Terminal Access.

## **Telnet**

An IP-based protocol for accessing a host computer over a network. Telnet can be used to access the MIRAN III Text-based User Interface over an LAN.

## **TUI**

Telephone User Interface. The interface a user can use to record, play, and assign and unassign announcements over a DTMF telephone.

## **VxWorks**

Wind River RTOS (Real Time Operating System). See RTOS.

## **.WAV**

File format used for storing voice files created under Microsoft Windows.

---

# Index

---

## A

- analog
  - channel passthrough, 108
- analog port, 20, 272
  - backplane signals, 272
- analog sources
  - external, 61
- announcements
  - emergency, 214
- application
  - examples, 65
  - music, 65
  - RAN, 65
  - RAN and MOH, 65
- architecture
  - design characteristics, 23
  - hardware, 34
  - MIRAN, 23
- audio device connection, 108
- audio jack, 38

## B

- backplane pinouts, 272, 273
- backplane signals, 273
- backup to PC Card, 122
- backup to PC Card Flash, 122

## C

- capacity
  - options (table), 24
  - voice storage, 56
- card installation
  - into Option 11 system, 99

- card replacement for MIRAN, 265
- CE-MUX signals, 41
- channels
  - cross-connect, 57
- codes
  - MIRAN hex codes, 268
- Commands, 262
- commands
  - Batch File commands, 213
  - file commands, 207
  - message commands, 201
  - miscellaneous commands, 211
  - syntax, 198
- commands summary table, 194
- configuration
  - restore, 123
- configuring
  - MIRAN characteristics, 85
  - MIRAN trunk data block, 85
  - sound recording, 267
  - terminal parameters, 135
  - time and date, 86
- connecting
  - audio device to MDF, 109
  - audio device to MIRAN faceplate, 109
  - external audio device, 108
  - multiple MIRAN cards, 105
  - terminal, 102
  - terminal to MDF, 103
  - terminal to MIRAN, 101
- connecting MIRAN to trunks (diagram), 95
- connection to music source, 38
- connections, I/O panel and MDF, 40

connectors

- MDF cable, 271
- MIRAN interface, 270

- converter DC/DC, 58
- cross-connect channels, 57
- cross-connect diagram, VPS, 95
- cross-connect ports
  - pinouts, 273

**D**

- DC/DC converter, 58
- device
  - security, 45
- diagnostic self-test, 43
- diagnostic self-tests, 258
- display
  - codes, 259
  - faceplate seven-segment, 259

**E**

- electrical
  - power (tables), 58
  - regulatory standards
    - electro-magnetic compatibility, 279
    - electro-magnetic immunity, 280
    - safety, 278
- electrical regulatory standards
  - electro-magnetic emissions, 279
- electro-magnetic compatibility, 279
- electro-magnetic emissions, 279
- electro-magnetic immunity, 280
- emergency messages, setting up, 214
- engineering
  - guidelines, 49
  - RAN and MOH, 65
- examples
  - RAN application, 66
- external music recording, 32

**F**

- faceplate
  - description, 38
  - diagram, 39
  - LED, 38
  - mini-DIN connector signals (table), 270
- fault isolation and correction
  - MIRAN, 262, 263
- Flash memory
  - increasing voice storage, 126
- functions monitoring, 44

**G**

- ground
  - analog, 58
  - frame, 58
  - logic, 58
- ground requirements, 57
- guidelines
  - engineering, 49

**H**

- hard reset, 42
- hardware list, 35
- hex codes
  - faceplate display, 40, 268

**I**

- identification
  - security, 46
- initialization
  - BIOS, 44
  - hardware, 44
- inspecting equipment, 91
- installation
  - MIRAN, 97
- installing MIRAN cards, 97
- interface, analog ports, 41
- interfaces, analog ports, 272
- internal music recording, 33
- inventorying equipment, 91
- IPE
  - MIRAN card slot location, 91



IPE module  
location of MIRAN (diagram), 99  
terminal connection, 102

IPE slots, pre-configured, 91

## **J**

jack  
audio input/output, 38

## **K**

keycode  
security, 47

## **L**

LAN  
connection at the MDF, 120  
multiple MIRAN connection, 117  
LED on faceplate, 38

## **M**

Main Menu, 264  
maintenance  
hex display, 40  
port, 40  
maintenance terminal requirements, 59  
MDF wiring, 92  
memory  
PC Card Flash, 19  
upgrades for RAN application, 123  
Meridian 1  
maintenance of MIRAN, 261  
messages  
for emergencies, 214

## **MIRAN**

architecture, 23  
capacity options, 24  
description of, 18  
faceplate, 38  
hardware list, 35  
I/O panel and MDF connections, 40  
location in IPE module (diagram), 99  
maintenance of, 261  
power requirements, 57  
purpose of, 13  
recording features, 22  
regulatory standards, 277  
security, 33  
storage capacity features, 22

## **MIRAN II, 19**

modem  
configuration, 274  
connecting to faceplate, 103  
connecting to I/O panel, 105

## **MOH**

conference loop, 83  
route, 83

## **monitoring**

built-in, 44  
sanity, 44, 261

multi cross-connect  
at the MDF, 94

multi cross-connect ports, 24, 54, 273

multi-channel RAN, 80

music-on-hold  
activation, 82  
MOH, 18  
route selection, 82

## **N**

NTAG36 MIRAN card, 18

## **O**

### **OA&M**

terminal-based  
menu system, 264

- OA&M access
  - telephone set-based, 61
- OA&M commands syntax, 198
- one-to-one ports, 24, 54
- Option 11
  - MIRAN installation, 105
  - terminal connection, 105
- options
  - port capacity, 54
- overview
  - installation, 90
  - maintenance, 258
- P**
- passthrough
  - analog, 108
- password
  - user, 34
- PC Card
  - cards for RAN upgrades, 124
  - dual-type socket, 38, 40
- PC Card Flash, 19
- pinout tables
  - analog port backplane, 272
  - faceplate mini-DIN connector, 270
  - multi cross-connect ports, 273, 274
- pinouts
  - interface connectors, 270
- port
  - analog, 41
  - capacity options, 54
- ports
  - accessing RS-232 serial, 41
  - analog, 272
  - MDF ports A and B, 41
  - multi cross-connect, 24, 54, 57, 273
  - one-to-one, 24, 54
- pre-configured IPE slots, 91

- R**
- RAN
  - configuring routes, 78
  - continuous delayed, 79
  - continuous immediate, 79
  - examples, 66
  - immediate start/stop, 81
  - multi-channel start/stop, 80
- RAN Application
  - browser user interface, 235
- RAN application
  - command summary, 194
  - emergency messages, 214
  - Main Menu, 264
  - menu system, 257, 264
  - security, 33
  - telephone user interface, 215
  - upgrades, 123
- RAN modes, 55
- recorded announcement
  - RAN, 18
- recording features, 22
- recordings
  - external, 32
  - internal, 33
- reliability, 275
- requirements
  - reset card procedure, 264
  - reset switch, 38
  - reset, soft, 43
  - restore configuration, 123
- RS-232
  - maintenance port, 40
- S**
- safety regulations (table), 278

- security
  - distributor password, 34
  - ID, 46
  - keycode, 47
  - RAN application, 33
  - security device, 45
  - software, 44
  - user password, 34
- self-test
  - diagnostic, 43, 260
  - sequence, 260
- signals
  - backplane, 272
  - DS-30X, 18
  - faceplate mini-DIN connector, 270
  - multi cross-connect, 273
- socket
  - Type II, dual type (PC Card), 38
- soft reset, 43
- software
  - security, 44
  - upgrade for RAN, 124
    - remote, 125
- sound recording
  - voice messages, 267
- special features
  - emergency messages, 214
- standards, regulatory, 277
- switchover
  - analog to internal, 108
- system options, 90

**T**

- telephone user interface
  - assigning an announcement, 219
  - description, 216
  - example, 222
  - flowcharts, 226
  - logging in, 217
  - port number assignments, 220
  - recording an announcement, 219
  - retrieving channel information, 221
  - the Main menu, 218
  - voice prompts, 223
- terminal
  - connection at the faceplate, 102
  - maintenance, 59
- terminal-based OA&M access
  - Calendar feature, 28
- tests
  - diagnostic self-tests, 258
- text-based user interface
  - MIRAN command set, 193
- Type II socket, dual type, 38, 40

**U**

- Universal Trunk Card emulation, 24
- unpacking equipment, 91
- upgrades
  - PC Card (diagrams), 124
  - RAN application, 123
  - software, 124
    - remote, 125
  - voice storage, 126

**V**

- voice prompts for OA&M, 223

**W**

- wiring to the MDF, 92

**X**

- requirements, 50





Meridian 1 and Succession Communication  
Server for Enterprise 1000

## **Meridian Integrated RAN**

### Description, Installation, and Operation

Copyright © 1997–2002 Nortel Networks  
All Rights Reserved

Information is subject to change without notice. Nortel Networks reserves the right to make changes in design or components as progress in engineering and manufacturing may warrant. This equipment has been tested and found to comply with the limits for a Class A digital device pursuant to Part 15 of the FCC rules, and the radio interference regulations of Industry Canada. These limits are designed to provide reasonable protection against harmful interference when the equipment is operated in a commercial environment. This equipment generates, uses and can radiate radio frequency energy, and if not installed and used in accordance with the instruction manual, may cause harmful interference to radio communications. Operation of this equipment in a residential area is likely to cause harmful interference in which case the user will be required to correct the interference at their own expense.

SL-1, Meridian 1, and Succession are trademarks of Nortel Networks.

Document number: 553-3001-112

Document release: Standard 5.00

Date: May 2002

Printed in Canada

