

555-7101-302

# CallPilot

## NMS Implementation and Administration Guide

Product Release 1.0      Standard 1.00      November 1998

---

---

**NORTEL**  
**NETWORKS™**

*How the world shares ideas.*



# CallPilot

## NMS Implementation and Administration Guide

---

NTP number:	555-7101-302
Product release:	1.0
Document release:	Standard 1.00
Date:	November 1998

---

1998, Northern Telecom

Printed in the United States of America

Information is subject to change without notice. Northern Telecom reserves the right to make changes in design or components as progress in engineering and manufacturing may warrant.

The process of transmitting data and call messaging between the Meridian 1 and the Meridian Application Server is proprietary to Northern Telecom. Any other use of the data and the transmission process is a violation of the user license unless specifically authorized in writing by Northern Telecom prior to such use. Violations of the license by alternative usage of any portion of this process or the related hardware constitutes grounds for an immediate termination of the license and Northern Telecom reserves the right to seek all allowable remedies for such breach.

This page and the following page are considered the title page, and contain Northern Telecom and third-party trademarks.



*How the world shares ideas.*

CALLPILOT, NORTEL, NORTEL NETWORKS, NORTEL NETWORKS HOW THE WORLD SHARES IDEAS, NORTHERN TELECOM, BNR, DMS, DMS-100, DMS-250, DMS-MTX, DMS-SCP, DNC, DPN, DUALMODE, HELMSMAN, IVR, LINK, MAP, MERIDIAN DIGITAL CENTREX (MDC), MERIDIAN, MERIDIAN 1, MERIDIAN LINK, MERIDIAN MAIL, MERIDIAN MAX, MFA, NORSTAR, SL-1, SL-100, SUPERNODE, SYMPOSIUM, and UNITY are trademarks of Northern Telecom Limited. TELESIS is a trademark of Bell-Northern Research.

ACCENT is a trademark of Accent Software International Ltd.

ACTION REQUEST SYSTEM and AR SYSTEM are trademarks of Remedy Corporation.

AMDEK is a trademark of Amdek Corporation.

ANSI is a trademark of the American National Standards Institute, Inc.

AT&T is a trademark of American Telephone and Telegraph Corporation.

ATRIA is a trademark of Pure Atria Corporation.

CASEWARE is a trademark of Caseware, Inc.

CLEARCASE is a trademark of Rational Software Corporation.

CONTINUUS and CONTINUUS/CM are trademarks of Continuous Software Corporation.

CRYSTAL REPORTS is a trademark of Seagate Software Inc.

FRAME, FRAMEBUILDER, FRAMEMAKER, and POSTSCRIPT are trademarks of Adobe Systems Incorporated.

HELVETICA and TIMES are trademarks of Linotype Corporation.

HITACHI is a trademark of Hitachi Limited.

LOGITECH is a trademark of Logitech, Inc.

MACINTOSH and APPLE are trademarks of Apple Computer Inc.

MICROSOFT, MICROSOFT WINDOWS, MICROSOFT WINDOWS NT, MS-DOS, and POWERPOINT are trademarks of Microsoft Corporation.

NOVELL is a trademark of Novell, Inc.

PCANYWHERE is a trademark of Symantec.

PROMARK and RHOBOT are trademarks of DMI Promark, Inc.

SONY is a trademark of Sony Corporation.

SYBASE is a trademark of Sybase, Inc.

3COM is a trademark of 3Com Corporation.

UNIX is a trademark of Novell, Inc.

WINRUNNER is a trademark of Mercury Interactive Corporation.

# Publication history

## **November 1998**

This is the Standard 1.0 issue of the *NMS Implementation and Administration Guide* for CallPilot 1.0 from Nortel Networks.



# Contents

<b>1</b>	<b>About CallPilot</b>	<b>11</b>
	<b>About this guide</b>	<b>13</b>
	Overview . . . . .	14
	Skills you need. . . . .	15
	Related information products . . . . .	16
	Using the online reference guides . . . . .	20
	Contacting technical support . . . . .	29
	How this guide is organized . . . . .	31
	Conventions . . . . .	33
	<b>Finding your way around CallPilot</b>	<b>35</b>
	Connecting to CallPilot . . . . .	36
	Multi-administrator access . . . . .	44
	Error handling in property sheets . . . . .	46
	Using the online Help . . . . .	49
<b>2</b>	<b>Getting started</b>	<b>55</b>
	<b>About Network Message Service</b>	<b>57</b>
	Overview . . . . .	58
	NMS benefits. . . . .	61
	Links and protocols . . . . .	63
	NMS and users. . . . .	64
	NMS access mechanisms. . . . .	65
	NMS features and considerations . . . . .	67
	Feature interaction . . . . .	71
	<b>Dialing plans and NMS</b>	<b>75</b>
	Overview . . . . .	76
	Dialing plans and NMS user locations . . . . .	77
	NMS dialing restriction scenarios . . . . .	80
	<b>Implementing NMS</b>	<b>83</b>
	Overview . . . . .	84
	Gather information . . . . .	85
	Configure the satellite switches. . . . .	86

NMS network configuration . . . . .	87
NMS site configuration. . . . .	89
<b>3 Gathering information</b>	<b>91</b>
Required information . . . . .	93
NMS network representation . . . . .	95
<b>4 Configuring the switches</b>	<b>97</b>
<b>About switch configuration</b>	<b>99</b>
Switches and NMS . . . . .	100
Confirming the Network Class of Service . . . . .	101
<b>Configuring the switch locations</b>	<b>103</b>
Overview. . . . .	104
Dummy ACD-DNs on satellite switch locations . . . . .	106
Phantom DNs and SDNs in an NMS network . . . . .	107
Switch overlays. . . . .	110
Prime switch configuration. . . . .	111
Configuring satellite switch locations. . . . .	113
Configuring telephones of users on satellite switch locations . . . . .	117
Upgrade an existing satellite switch . . . . .	118
SDN Table and NMS . . . . .	119
Services not in the SDN Table . . . . .	122
Adding and configuring SDNs in the SDN Table . . . . .	123
<b>5 Configuring CallPilot for NMS</b>	<b>127</b>
<b>Configuring the Meridian Application Server</b>	<b>129</b>
Overview. . . . .	130
Configuring the local messaging server . . . . .	132
<b>Configuring the switch locations</b>	<b>137</b>
About configuring the local prime switch location . . . . .	138
Configuring the ESN information. . . . .	144
Configuring the CDP information . . . . .	147
Adding and configuring a satellite switch location . . . . .	150
Recording a spoken name. . . . .	153
Importing a spoken name . . . . .	155



---

	<b>Additional administrative tasks</b>	<b>157</b>
	Sharing the configuration information . . . . .	158
	Adding local users . . . . .	159
<b>6</b>	<b>Testing and backing up NMS</b>	<b>161</b>
	<b>Tests and backups</b>	<b>163</b>
	Overview . . . . .	164
	Testing the NMS network . . . . .	165
	Backups . . . . .	167
<b>7</b>	<b>Maintaining NMS</b>	<b>169</b>
	<b>About maintaining NMS</b>	<b>171</b>
	Overview . . . . .	172
	Network history . . . . .	174
	Printing configuration information . . . . .	175
	<b>Regularly scheduled maintenance tasks</b>	<b>177</b>
	Reviewing OM reports and alerts . . . . .	178
	<b>As-required maintenance tasks</b>	<b>181</b>
	Modify the local messaging server . . . . .	182
	Modify the prime switch location . . . . .	183
	Adding, modifying, and deleting satellite switch locations. . . . .	185
<b>8</b>	<b>Troubleshooting NMS</b>	<b>187</b>
	Overview . . . . .	189
	Problem: User unable to log in to mailbox . . . . .	191



# chapter 1

---

## About CallPilot

This chapter introduces CallPilot, the powerful multimedia messaging system from Nortel Networks. CallPilot offers a single solution for managing many types of information, including voice mail, fax-mail, e-mail, telephone calls, conferencing, calendars, directories, and call logs.

CallPilot enables you to get all the information you need from one source, whether through display-based telephone sets, your wireless set, your Windows desktop computer, a speech recognition interface, or another personal communications device.

### In this chapter

<a href="#">About this guide</a>	13
<a href="#">Finding your way around CallPilot</a>	35



# About this guide

## In this section

<a href="#">Overview</a>	14
<a href="#">Skills you need</a>	15
<a href="#">Related information products</a>	16
<a href="#">Using the online reference guides</a>	20
<a href="#">Contacting technical support</a>	29
<a href="#">How this guide is organized</a>	31
<a href="#">Conventions</a>	33

# Overview

## Introduction

The *NMS Implementation and Administration Guide* provides the information and procedures that are necessary to implement NMS.

## Assumptions

This guide assumes that the Meridian Application Server has been correctly installed and is operational. If the application has not been installed, then install it before proceeding. For installation instructions, refer to the hardware installation guide appropriate to your server type.

If the server has been installed but is not operational, refer to the *Maintenance and Diagnostics Guide* for information on troubleshooting your system.

# Skills you need

## Introduction

You need certain skills and knowledge to use this guide effectively.

## Nortel Networks product knowledge

Knowledge of, or experience with, the following Nortel Networks products will assist you:

- Meridian 1
- Meridian Mail

## PC experience or knowledge

Knowledge of, or experience with, the following PC products will be of assistance. This guide does not document the following functionality:

- Microsoft Windows NT
- Microsoft Windows 95

## Other experience or knowledge

Other types of experience or knowledge that may be of use include the following:

- network management
- client-server systems
- flowcharting

# Related information products

## Introduction

Following is a list of all CallPilot technical documents. The CD-ROM that you receive with your system contains these guides, enabling you to search the entire suite of documentation online. If you prefer, you can print out entire guides, or parts of a guide.

You order copies of these documents using the NTP numbers or P0 numbers provided.

## Planning and migration

These guides are used before CallPilot is installed to help you plan your system and, if you have a Meridian Mail system, migrate to CallPilot.

<b>Document Title</b>	<b>NTP number</b>
Planning and Engineering Guide	555-7101-101
Meridian Mail to CallPilot Migration Guide	555-7101-801



## Installation guides

These guides describe how to install server hardware and CallPilot software.

<b>Document Title</b>	<b>NTP number or P0 number</b>
Meridian Application Server 200i Installation Guide	P0884895
Meridian Application Server 702t Installation and Maintenance Guide	P0884909
Meridian Application Server 1001rp Installation and Maintenance Guide	P0886776
Software Installation Guide	555-7101-200

## Administration and feature guides

These guides describe how to configure CallPilot, administer and maintain it, and use its features.

<b>Document Title</b>	<b>NTP number</b>
Basic Administration Guide	555-7101-300
Advanced Administration Guide - volume 1	555-7101-301
Advanced Administration Guide - volume 2	555-7101-301
Reporter Guide	555-7101-310
Application Builder Guide	555-7101-325

## Networking guides

These guides describe how to plan, install, set up, and troubleshoot networking services.

<b>Document Title</b>	<b>NTP number</b>
Networking Planning Guide	555-7101-100
NMS Implementation and Administration Guide	555-7101-302
AMIS Networking Implementation and Administration Guide	555-7101-303
Enterprise Networking Implementation and Administration Guide	555-7101-304
Integrated AMIS Networking Implementation and Administration Guide	555-7101-305
VPIM Networking Implementation and Administration Guide	555-7101-306

## Maintenance and troubleshooting guides

These guides describe how to maintain your system once it is in service and help you troubleshoot operational problems.

<b>Document Title</b>	<b>NTP number</b>
Maintenance and Diagnostics Guide	555-7101-500
Support Tools Guide	555-7101-800

## End user guides

These guides are intended for end users of CallPilot, such as telephone set users and desktop messaging users.

<b>Document Title</b>	<b>P0 number</b>
Speech Activated Messaging User Guide	P0886127

<b>Document Title</b>	<b>P0 number</b>
Multimedia Messaging Quick Reference Card	P0886128
Multimedia Messaging User Guide	P0886140
Desktop Messaging for Microsoft Exchange Guide	P0886141
Desktop Messaging for Lotus Notes Guide	P0886142
Internet Messaging Guide	P0886143

---

## **CD ROM**

The CD-ROM contains all the listed documents, except the end user guides.

<b>Document Title</b>	<b>Order number</b>
CallPilot Technical Documentation CD	NTRG19AA A0742811

---

# Using the online reference guides

## Introduction

The online reference guides contain the same procedures and context-sensitive information that you find in the online Help. However, the guides contain additional information not included in the online Help. These guides have overview sections that describe concepts and features and provide other CallPilot information.

To print an online guide, see [Printing an online guide](#) on page 28.

## The online guides

The following reference guides are available online.

- *Overview Guide*
- *Advanced Administration Guide*
- *Application Builder Guide*
- *Reporter Guide*
- Networking guides
  - *Networking Planning Guide*
  - *AMIS Networking Implementation and Administration Guide*
  - *Integrated AMIS Networking Implementation and Administration Guide*
  - *Enterprise Networking Implementation and Administration Guide*
  - *VPIM Networking Implementation and Administration Guide*
  - *NMS Implementation and Administration Guide*

## To access the online guides

- 1 On the Help menu, click Reference Guides.

**Attention:** If you see the following error message, Adobe Acrobat was not installed during the MAS software installation. Refer to the *Software Installation Guide* for the Acrobat Installation procedure.

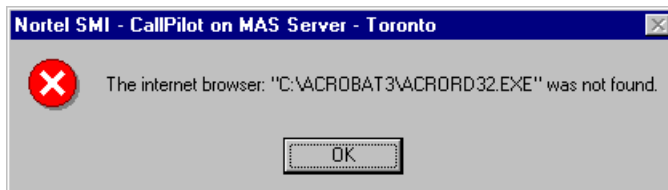

- 2 Click the document you want to open.

**Result:** The front cover is displayed. Select a chapter from the front cover or from the bookmarks displayed in the left frame.

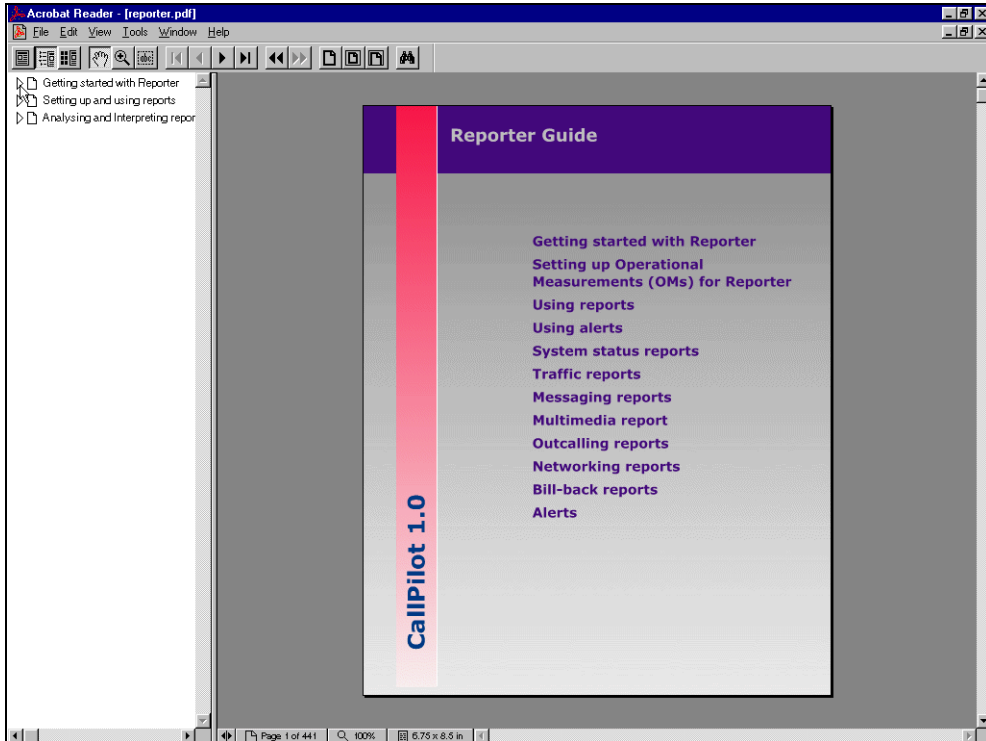

## Navigating the online guides

There are several ways to navigate through the guides and to find specific topics.

## Bookmarks

Bookmarks are displayed on the left-hand side of each document. To go to a specific part of the document, such as a chapter or section, click the bookmark.

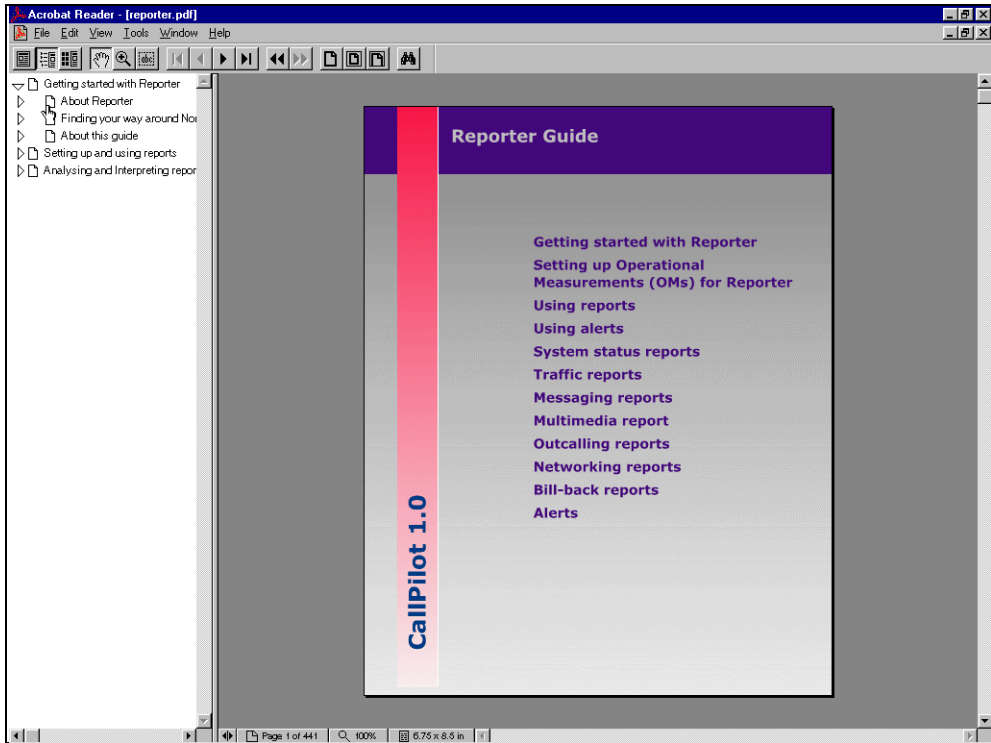

## Using hypertext links

Once you find the chapter or section you are interested in, use hypertext links to navigate within the chapter and document.

Links appear as blue underlined text.

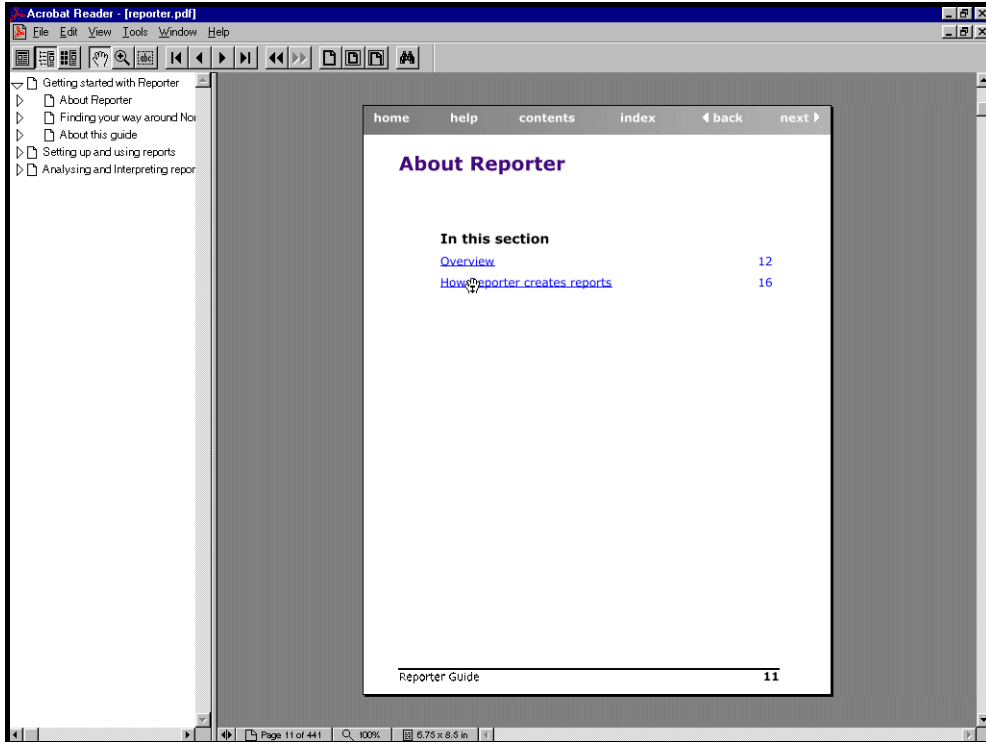



When you click a link, the selected topic is displayed.

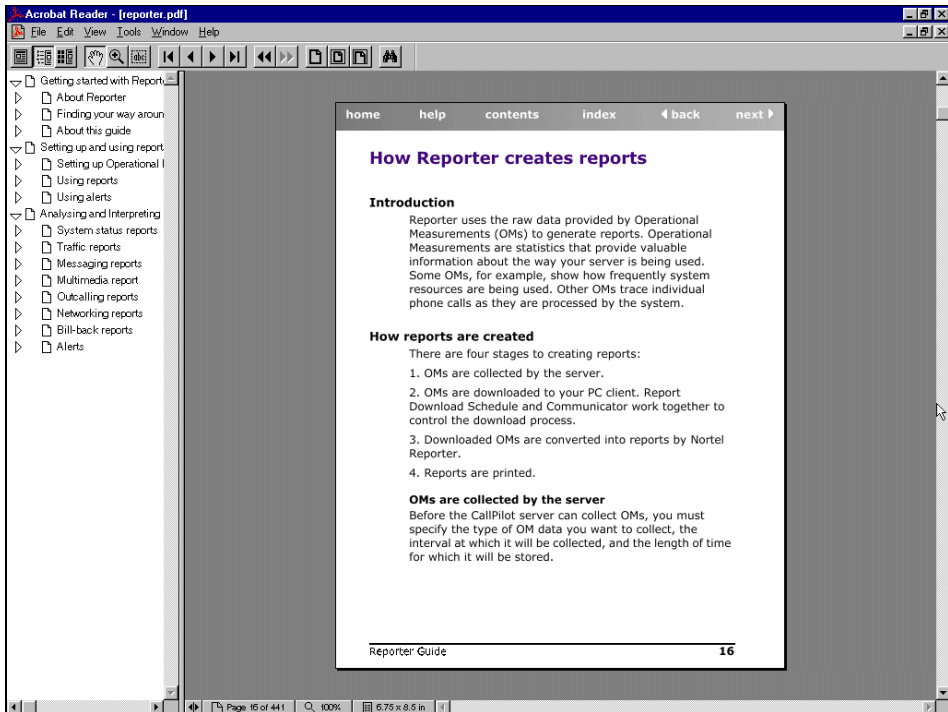

### Using the document button bar

The online guides have a button bar at the top of each page to help you get around quickly.





On each page you can use the following buttons:

Button	Description
home	Goes to the cover page of the current guide.
help	Provides tips on how to use the online guides.
contents	Goes to the table of contents for the current guide.
index	Goes to the index for the current guide.
back	Goes to the previous page in the guide.
next	Goes to the next page in the guide.

### Using Acrobat Reader commands

Adobe Acrobat Reader also has features to help you work through the document. You can learn more about Reader by accessing its online guide from the Acrobat Reader Help menu.





Here are some of the more common commands:

Function	Description
	Goes back to the last view and forward to the next view.
	Goes to the previous page and to the next page in the document.

Function	Description
	Goes to the first page of the document and to the last page of the document.

### Searching for information

You can use the Acrobat Search tool to find specific information. This tool enables you to find all instances of a word or phrase. You can search either the current guide or all the online guides.

Search function	Description
	Searches the current document for all instances of the word or phrase you type. Goes to the first page that has at least one instance of the word or phrase, and highlights your choice.
	Searches all the online guides for the word or phrase you type. Displays a list of the guides containing the search word or phrase. The guide you select opens to the first page that has at least one instance of the word or phrase, and highlights your choice.
	Goes to the next instance of the word or phrase.
	Goes to the previous instance of the word or phrase.

## Printing an online guide

For best results when you print an online guide, use a Postscript-compatible printer capable of 600 dpi output. If a Postscript printer is not available, use Adobe Acrobat 3.0 (not Acrobat 3.01). Acrobat 3.0 is installed by default with the CallPilot 1.0 Administration client software. It is also available from <http://www.adobe.com>.

## To set print properties for an online guide

- 1 In Acrobat Reader, open the file for the online guide.
- 2 From the File menu, select Print Setup...
- 3 In the Print Setup dialog box, select Properties.
- 4 Select the Graphics tab.
- 5 Select Resolution, and then select 600 dpi.
- 6 Click OK until you exit from all the dialog boxes.

**Note:** Your screens should print out legibly, even on a non-Postscript printer.

## To print an online guide

- 1 From the File menu, select Print.
- 2 Indicate the page range.
- 3 Click OK.

# Contacting technical support

## Introduction

Contact your distributor's technical support organization to get help with troubleshooting your system.

Before contacting Technical Support, ensure that you have the necessary information on hand.

## Information about your server

Technical Support may ask for the following information, which is displayed in the Server Settings window:

- server version number
- release number
- serial number (if you have this number available)

**Getting there** Nortel SMI > Meridian Application Server > System Administration

## To view server settings

- 1 Double-click System Configuration.
- 2 Double-click Server Settings.

## Identifying Field Replacement Units (FRUs)

If you have diagnosed a hardware problem and need to order a replacement part, you must be able to identify the part.

For more information about running diagnostics on hardware components and identifying field replacement units, see the *Maintenance and Diagnostics Guide*.

## Contacting Nortel Networks

If you have comments or suggestions for improving CallPilot and its documentation, Nortel Networks would like to hear from you. Please see the following address:

[http://www.nortelnetworks.com/callpilot\\_feedback](http://www.nortelnetworks.com/callpilot_feedback)

# How this guide is organized

## Introduction

The *NMS Implementation and Administration Guide* is organized in the sequence of tasks required to successfully implement NMS for CallPilot. Start at the beginning of the guide and work your way through it until all required tasks are completed.

## Contents

This guide contains the following chapters.

Chapter title	Description
<a href="#">Chapter 1. About CallPilot</a>	This chapter describes how to work with the CallPilot interface and how to use this guide.
<a href="#">Chapter 2. Getting started</a>	This chapter provides an overview of NMS. This chapter describes the features supported by NMS and how NMS works. This chapter also provides a high-level overview of the tasks that are performed during implementation.
<a href="#">Chapter 3. Gathering information</a>	This chapter explains how to gather the information required to implement NMS.
<a href="#">Chapter 4. Configuring the switches</a>	This chapter explains how to configure the switches for NMS.
<a href="#">Chapter 5. Configuring CallPilot for NMS</a>	This chapter describes how to configure CallPilot for NMS. This chapter describes how to configure the local site and all satellite switch locations. This chapter describes every box that must be completed and provides detailed procedures.

---

<b>Chapter title</b>	<b>Description</b>
<a href="#"><u>Chapter 6. Testing and backing up NMS</u></a>	This chapter describes how to test the implementation of NMS to ensure that it is properly configured. This chapter also describes how to perform a backup of the system.
<a href="#"><u>Chapter 7. Maintaining NMS</u></a>	This chapter explains how to perform both regularly scheduled maintenance tasks and as-required maintenance tasks.
<a href="#"><u>Chapter 8. Troubleshooting NMS</u></a>	This chapter provides information to identify and solve problems with NMS.

---



# Conventions

## Introduction

This guide uses the following conventions.

## How commands are documented in procedures

As with many Windows applications, there are several different ways to execute a command. For example, to copy text, you can choose any of the following methods:

- Choose Copy from the Edit menu.
- Click the Copy button on the toolbar.
- Type the keyboard shortcut Control + C.

The procedures in this guide document only the first method, choosing a command from a menu.

## Navigation information in procedures: Getting there

Procedures in this guide are preceded by a **Getting there** statement. This statement summarizes the steps you take to navigate to the window or tab where the procedure is carried out.

All Getting there statements start at the Nortel SMI window. This assumes you have logged on and selected the appropriate system. Each item mentioned after that represents an icon, window, or tab that makes up the path to the final destination.

### Example

To define special mailboxes such as the broadcast mailbox, you must be on the Mailboxes tab. The Getting there statement for this procedure is as follows:

**Getting there** Nortel SMI > Meridian Application Server > CallPilot > Messaging Administration

After you double-click Messaging Administration, the property sheet displays. You then click the Mailboxes tab.

The screenshot shows a dialog box titled "Messaging Administration Properties - Church Street - Uptown Site". It has five tabs: "General", "DNs and Prefixes", "Mailboxes", "Holidays", and "Dialing Information". The "Mailboxes" tab is selected. The dialog is divided into several sections:

- Broadcast mailbox:**
  - Mailbox number:
  - Mailbox personal verification:
- Alarm mailbox:**
  - Alarm mailbox number:
  - Severity to:
- General delivery mailbox:**
- Networking Loopback:**
- System Greetings:**
  - Primary language:
  - Secondary language:

At the bottom of the dialog are four buttons: "Save", "Cancel", "Print", and "Help".

# Finding your way around CallPilot

## In this section

<a href="#">Connecting to CallPilot</a>	36
<a href="#">Multi-administrator access</a>	44
<a href="#">Error handling in property sheets</a>	46
<a href="#">Using the online Help</a>	49

# Connecting to CallPilot

## Introduction

To perform administrative tasks, or to build or work with CallPilot applications, you must first connect to the Meridian Application Server (the MAS server). The MAT Navigator and the System Management Interface (SMI) work together to give you access to your system and sites.

## Selecting a system—the MAT Navigator

The first step in logging in is to launch the MAT Navigator, which has its own password. The MAT Navigator connects your administration client to the MAS server. It displays all your sites and systems and enables you to select one to work on.

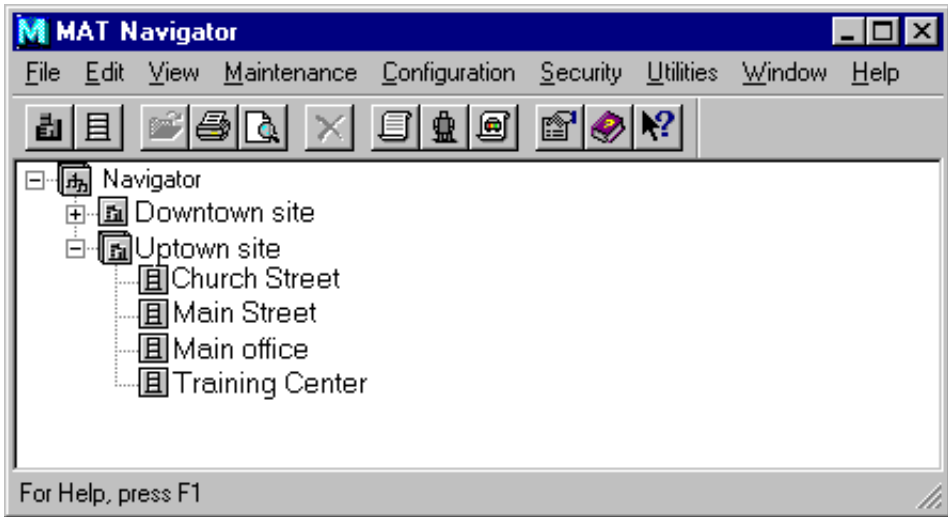

## Selecting a program—the System Management Interface (SMI)

When you select a system from the MAT Navigator, you are prompted for a second password. At this point, the SMI window for the selected system or site displays.

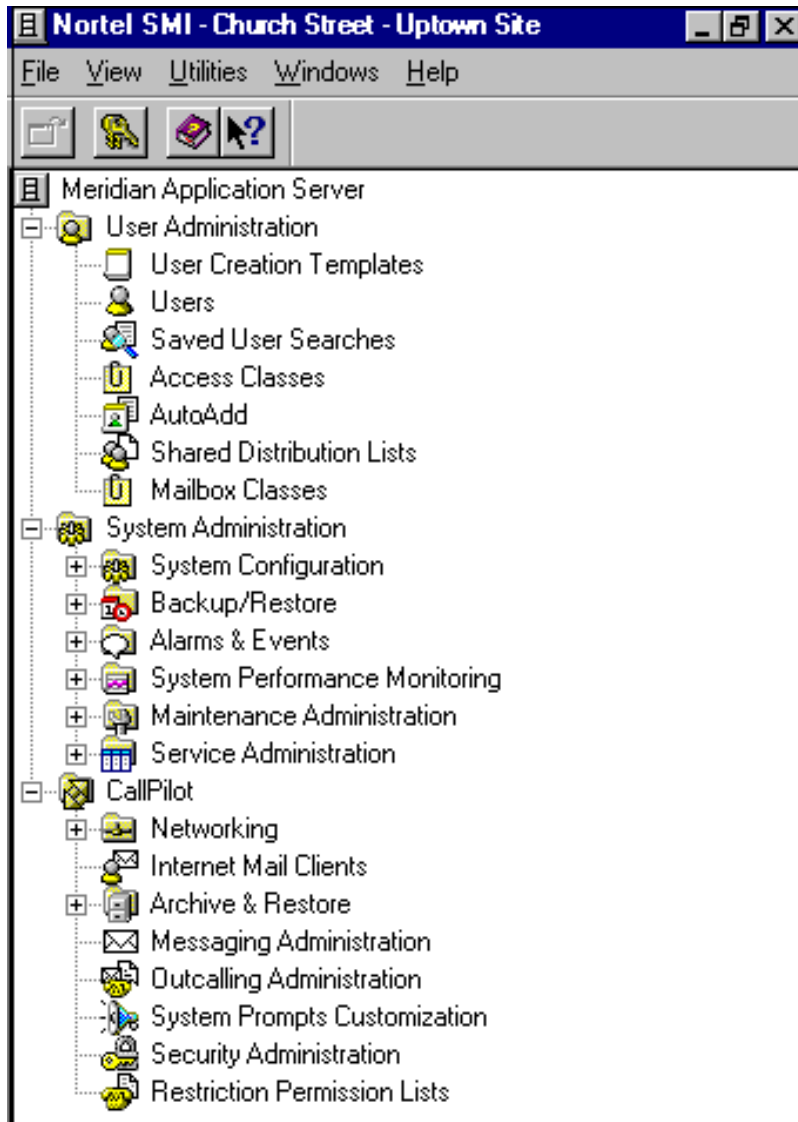

The SMI gives you quick and easy access to your system or sites. The SMI uses a navigation tree to display the system's hierarchy. In the tree, icons represent the folders and programs. Double-click a folder icon to view its contents. Folders can contain programs and other folders. Double-click a program icon to run the associated program.

### Selecting an object—list views

When you launch certain programs, the first thing you see is a list view. The list view displays all the objects of a certain type (such as mailbox classes) that are currently defined in the system. The list view includes predefined objects as well as those defined by an administrator. From the list view window, you can select a specific object to work on.

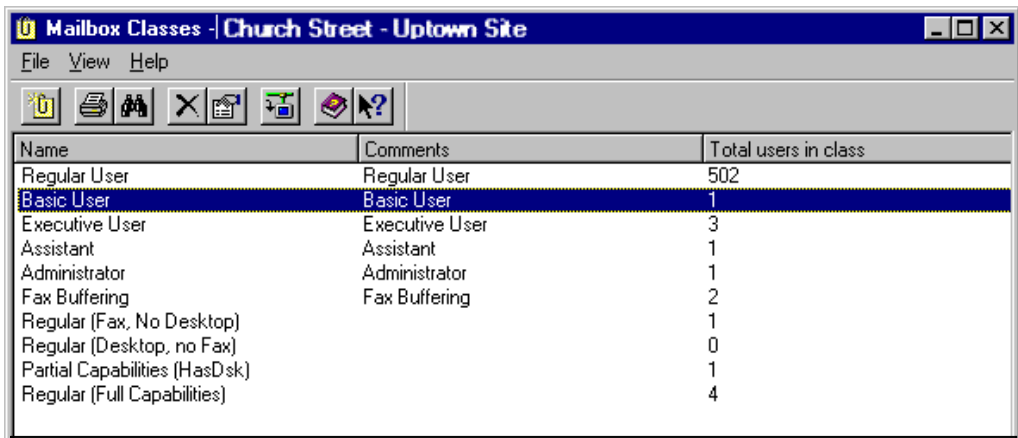

### **Viewing and changing properties**

Select an object and display its properties by

- double-clicking it or
- single-clicking it and selecting Properties from the File menu
- right-clicking it and selecting Properties from the popup menu

### **Entering data and choosing options—property sheets**

A property sheet is displayed when you view an object selected from a list view. Certain programs, such as Messaging Administration, display a property sheet immediately after launching. Property sheets have one or more tabs. Each tab has fields, referred to as boxes, in which you can type data or from which you can select options.

Most CallPilot property sheets look like the following:

**Basic Users - Mailbox Classes Properties** [?] [X]

Mailbox | Call handling | Media | Remote Notification | RPLs

Name: Basic Users

Comment: Basic Users

Storage

Voice storage limit: 0003 minutes

Delete read messages (voice): after: 05 days

Delete read messages (fax): after: 05 days

Block call answering when mailbox is full

Retain copy of sent messages

Revert DN set by telset

Max composed message length: 03:00 mm:ss

Max call answering message length: 02:00 mm:ss

Language for automated services: system primary

Save Cancel Print Help



Some property sheets are divided into two panes. When a box is checked in the left pane, the selected capabilities are enabled and you can access the associated tabs. Select a tab by clicking its name in the left pane or by clicking the tab in the right pane. These property sheets look like this:

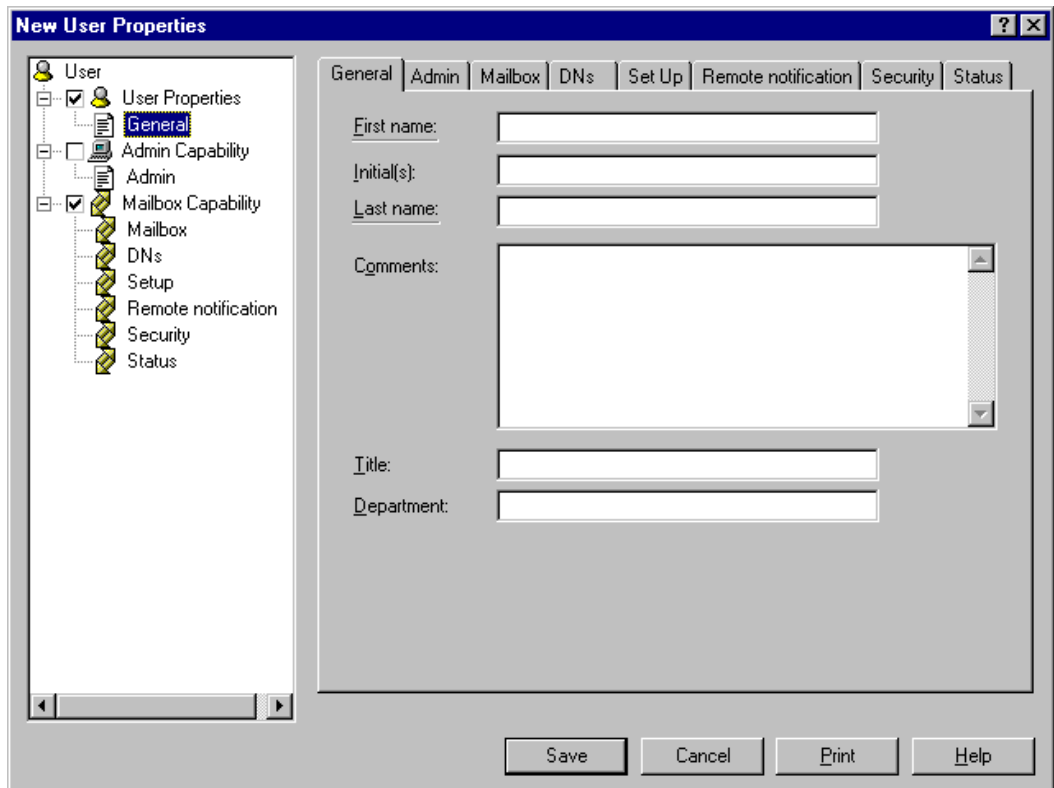

### Mandatory boxes

If the name of a box is underlined, the box is mandatory, and you must fill it in. You cannot save if any mandatory boxes are empty.

## Common buttons



The following buttons appear on most property sheets:











Button	Description
Save	Saves all changes made on any of the tabs in a property sheet and closes the property sheet. Therefore, save only when you have made the necessary changes on all tabs.
Cancel	Closes the property sheet without saving any changes.
Print	Prints the contents of all tabs in the property sheet.
Help	Displays Help for the current tab. From this overview Help topic, you can access other Help topics, the index, and the search function.

## Using the toolbar buttons

For easier access, some of the more common tasks, such as Print and Save, are represented as buttons on the toolbar.

The following buttons are used throughout CallPilot. Buttons or icons specific to certain CallPilot functions, such as backups and archives, are documented in the relevant chapters.

Toolbar button	Description
	Saves any changes you have made and then transfers all the application's data to the server.
	Opens the Print dialog box and prints the active file or the objects you specify.
	Deletes the object you select.

Toolbar button	Description
	Displays the properties of the object you select.
	Displays the Help topics window.
 	Explains the next menu item or screen object you click. In a window, there is an arrow. On tabs or in dialog boxes, there is no arrow.
 	Opens the New dialog box, where you identify the properties of the object you are creating. The button looks different in different applications.
 	Displays the Open dialog box, where you select an object to open. The button is different in different applications.
	Reloads the current page and displays the changes you have made.
	Enables you to select how the system displays icons.

# Multi-administrator access

## Introduction

You can create multiple administrator accounts to make administering CallPilot easier and more efficient. Multiple accounts enable administration responsibilities to be distributed among a number of people. Therefore, certain administrators can specialize in certain tasks, such as maintaining users, performing backups, analyzing reports, or creating multimedia services.

## Access classes

For security reasons, administrators should be given access only to those parts of the system that relate to their role. For example, an administrator who is responsible only for creating multimedia services should have access only to Application Builder and the Service Directory Number Table.

Each administrator account is assigned an access class. An access class is a list of the parts of the system and the level of access allowed. The access levels are as follows:

- create/delete (enables an administrator to delete objects such as users and services)
- edit
- view
- none

For example, an administrator may be able to create or delete objects in Application Builder but only view User Templates.

## Simultaneous access

Multiple administrators can log in to CallPilot at the same time without overwriting other work.

If you are the first to log in to a particular resource, such as a specific mailbox class or user profile, and another administrator tries to access the same resource, a dialog box appears to inform you of the other administrator. At this point, you can do one of the following:

- Keep editing.
- Save your changes, and release the resource to the other administrator.
- Cancel your changes, and release the resource to the other administrator.

If you do not respond to this prompt within two minutes—because you are away from the terminal, for example—the system releases the resource so that others can access it. If this happens, all your unsaved changes are lost.

An administrator who accesses a resource that is currently being edited sees a read-only view of the property sheet in which all boxes are dimmed. This indicates that the resource is currently locked. The administrator is not notified when the resource is released, but must try to access the property sheet again to see whether its status has changed.

If a user tries to log on to a mailbox while an administrator is changing the profile, the user is unable to log on and receives a message that says the mailbox is in use.

## Refreshing screens

Because multiple administrators can access the same database at the same time, a Refresh command is available from the View menu to ensure that the view you are seeing is the most up-to-date.

For example, if you are viewing a list of users when another administrator deletes a user, the only way to see the change is to refresh the screen. You should, therefore, refresh the screen regularly.

# Error handling in property sheets

## Introduction

If you make certain types of errors while entering data, you are not able to save your changes until you correct the errors. For example, if you leave a mandatory box empty, you receive a message prompting you to fix it.

**Note:** These errors do not show up in the Event Browser or Alarm Monitor because the errors relate only to data entry and are not operational problems.

## How error handling works

There are two types of error messages.

### Type 1

If you get this type of error message, click OK, and then fix the problem described in the message before you try to save again.

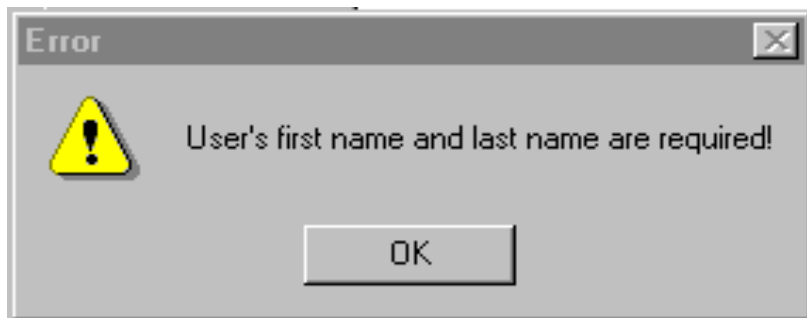

## Type 2

If you get this type of error message, click OK to see a list of errors.



Double-click an error from the list. Your cursor is automatically placed in the box where the error was made so that you can correct it.

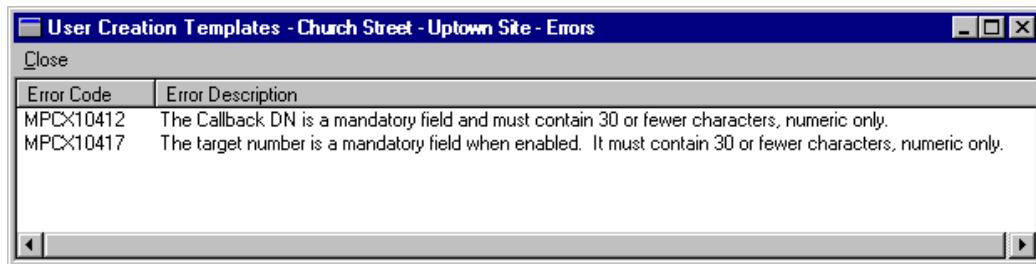

For example, if you double-click the second error, the Remote notification tab is displayed, with the cursor in the Target number box.

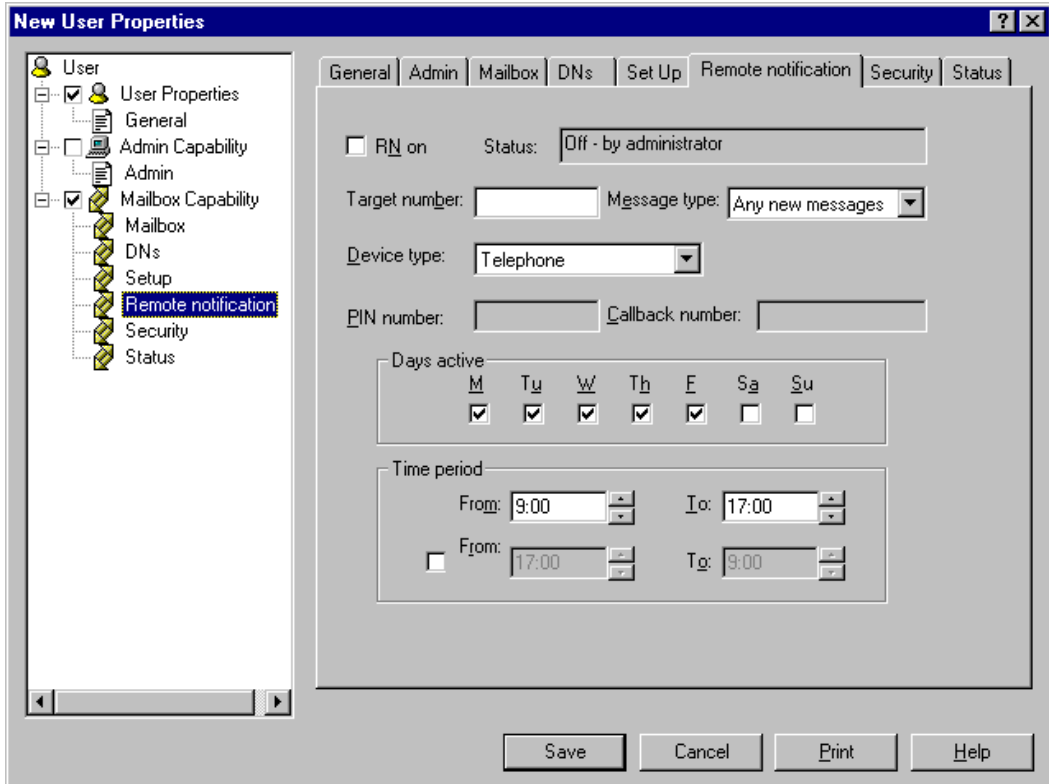



# Using the online Help

## Introduction



While administering or maintaining CallPilot, you may have questions about the purpose of certain boxes and buttons, or need more information about completing certain tasks.

Online Help provides brief answers to the questions “What’s this?” and “How do I...?”

## Context-sensitive Help

If you need to know the purpose of a particular box or button, use context-sensitive Help.

### To access context-sensitive Help

- 1 Click the  icon in a window or the  icon on a tab or in a dialog box.
- 2 Point to the box or button for which you want more information, and click.

**Result:** A pop-up description of the selected object is displayed.

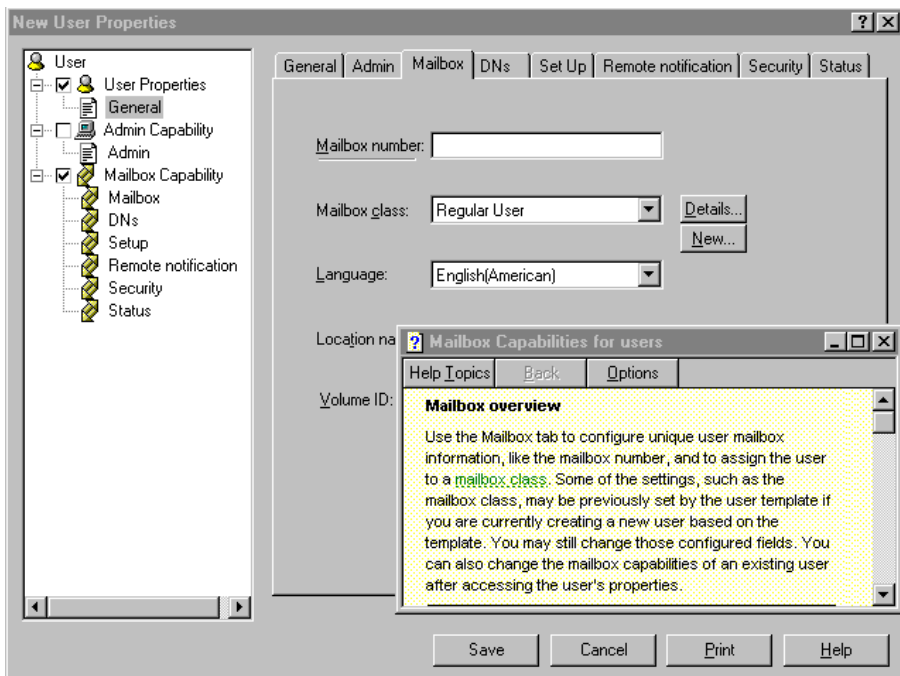

## Procedures

If you need to know how to do something, you can access procedures to lead you through a task.

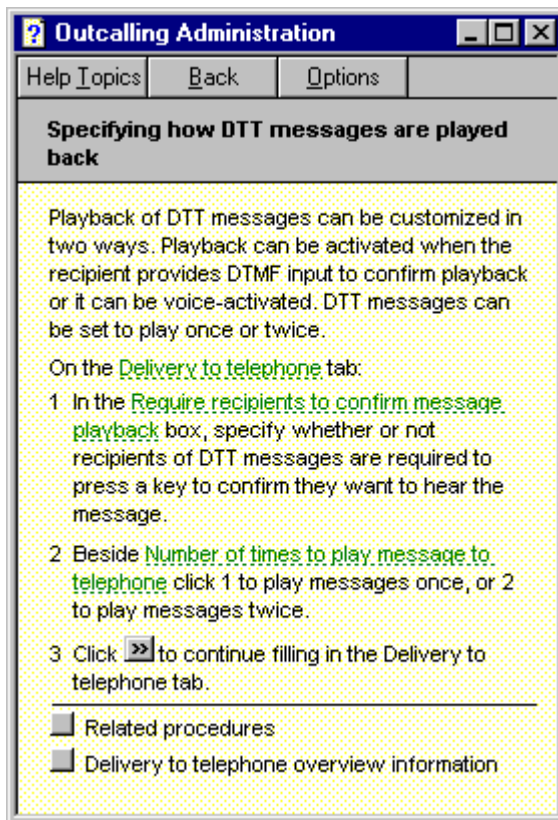

## High-level tasks

In some cases, high-level tasks take you through longer procedures. These tasks also provide you with navigation to the step-by-step procedures they include.

For example, setting up Delivery to Telephone requires several procedures. The high-level task summarizes these procedures. You click the gray buttons within the task to open the step-by-step procedures. The high-level task remains on your screen so that you can continue to use it to move through the procedures.

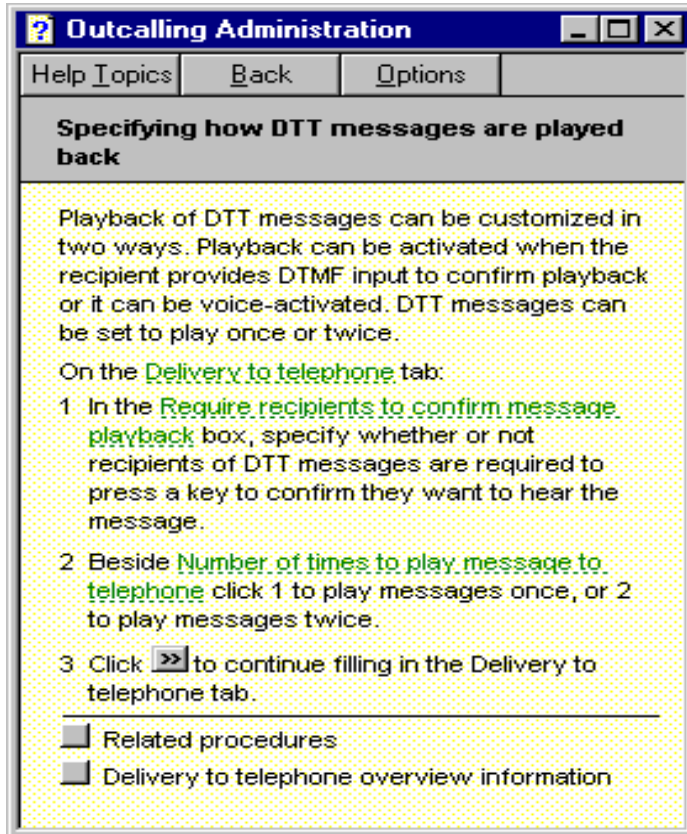

## Overviews

Overview topics provide brief descriptions of tabs, features, and the tasks carried out from the tabs. However, the online guides contain more detailed feature descriptions.

### To access overview topics

Click the Help button on a tab.

## To find information in Help

You can look up procedures and overview topics in the following ways:

- 1 From the Help menu, select Help Topics.  
**Note:** You can also press F1 on the keyboard.
- 2 Go to one of the following tabs:
  - To see the table of contents of all the Help topics, select the Contents tab.
  - To look up a subject alphabetically, select the Index tab.
  - To do a full-text search to find topics that contain the words you enter, select the Find tab.



## chapter 2

---

# Getting started

This chapter introduces Network Message Service (NMS) and provides a basic overview of the implementation process.

This chapter also covers some basic networking concepts and terminology that are useful for understanding NMS.

### In this chapter

<a href="#">About Network Message Service</a>	57
<a href="#">Dialing plans and NMS</a>	75
<a href="#">Implementing NMS</a>	83





# About Network Message Service

## In this section

<a href="#">Overview</a>	58
<a href="#">NMS benefits</a>	61
<a href="#">Links and protocols</a>	63
<a href="#">NMS and users</a>	64
<a href="#">NMS access mechanisms</a>	65
<a href="#">NMS features and considerations</a>	67
<a href="#">Feature interaction</a>	71

# Overview

## Introduction

Network Message Service (NMS) is a CallPilot feature that enables one Meridian Application Server to provide messaging services to users in a network of compliant switches.

## NMS network

The collection of switch locations, connections, and the messaging server is collectively known as an NMS network.

The following diagram illustrates an NMS network consisting of the Meridian Application Server, a prime switch location, and two satellite switch locations. Only the prime switch location is directly attached to the server.

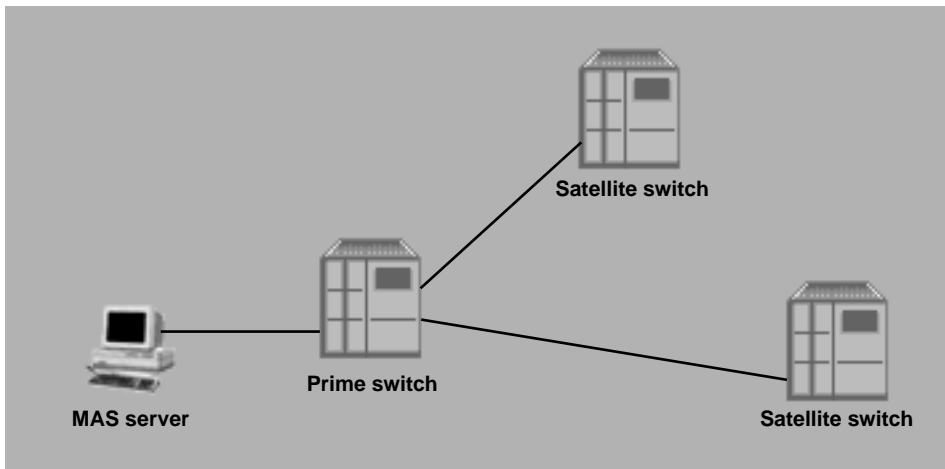

G100947.eps

## NMS site

An NMS network is often a site within a more complex messaging network.

When an NMS network is part of a messaging network, it is called an NMS site. A messaging network can have many NMS sites.

In the following diagram, the messaging network consists of six sites. Site 5 and Site 6 are NMS sites. CallPilot networking solutions are implemented on all sites.

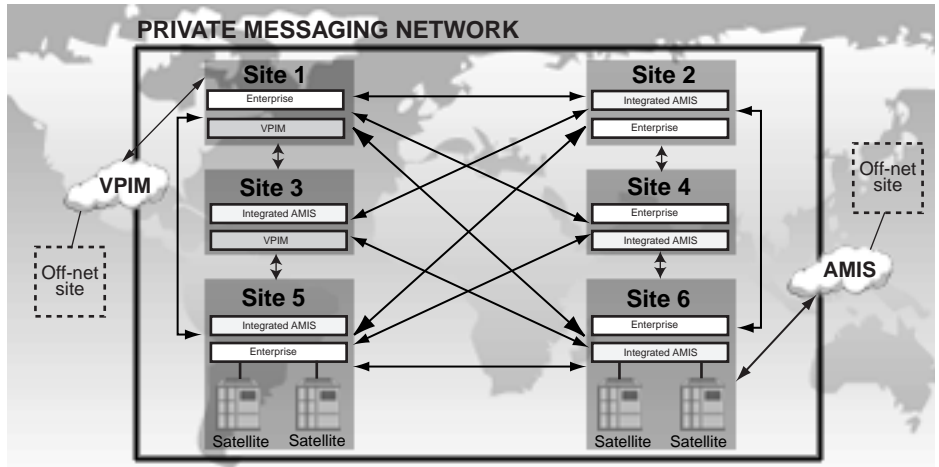

G101139.ej

## Private messaging network

A private messaging network is made up of two or more sites that are connected by communication channels. These channels are maintained and restricted for an organization's private use.

## NMS networks are private

An NMS network is a type of private messaging network. An NMS network is set up and maintained by an organization for private use.

An NMS site is part of a private messaging network.

## Typical private messaging network

In a typical private messaging network, every switch is connected to a messaging server. Users connected to a switch have mailboxes and can exchange messages with other users connected to the same switch.

Users can also send messages to users on other switches in the network. This capability is known as network messaging.

The messaging servers use a networking protocol, either analog or digital, to communicate with one another.

## Key terms

The following terms are used in discussions of NMS:

Term	Definition
NMS network	■ The interconnected switches and the Meridian Application Server
NMS site	■ An NMS network when it is part of a larger messaging network in which each site has its own server
Prime switch location	■ The switch location directly attached to the Meridian Application Server
Satellite switch location	■ A switch location that is directly connected to the prime switch
Tandem switch location	■ A switch location that is connected between the prime switch location and a satellite switch location
User location	■ A logical grouping of mailboxes; may be the mailboxes on one switch or the mailboxes on two or more switches

# NMS benefits

## Introduction

An NMS network is not a typical private network. The network offers several unique benefits, including

- cost savings
- efficiency
- transparency
- flexibility

## Cost savings

NMS connects several switches to a single Meridian Application Server. Since each switch does not require its own server, NMS offers considerable cost savings in both hardware and maintenance.

NMS enables you to have centralized administration, which helps control the cost of ownership. Although the actual switch configuration must be completed at each switch location, the configuration required to make the switches work with CallPilot is centralized.

From one Meridian Application Server, you can implement and maintain the server and all switches in the NMS network.

## Efficiency

With NMS, the spare capacity on a Meridian Application Server can be applied to more end-users. Users at locations that are too small to have their own dedicated messaging servers and switches can become part of an NMS network.

## Transparency

All users have a mailbox on the Meridian Application Server. Users on all switches in an NMS network have access to all multimedia messaging features and access them in the same way. The CallPilot feature operation is transparent to users. Users do not know that they are part of an NMS network.

This transparency is achieved by the configuration. User telephones on satellite switches are configured to call forward to the prime switch. The prime switch is configured to route NMS messages to CallPilot.

## Flexibility

Because NMS can be combined with the other networking solutions offered by CallPilot, you can create a scalable messaging network that is customized to meet your specific needs.

# Links and protocols

## Introduction

NMS uses links and protocols to connect the parts of the NMS network and to transmit messages.

## Prime switch location and satellite switch locations

The switches are connected by Integrated Service Digital Network (ISDN) primary rate access (PRA), and ISDN signaling link (ISL) trunks.

The prime switch communicates with the satellite switches with the D channel of Primary Rate Interface (PRI) (64 kbit/s).

The prime switch location and the satellite switch locations communicate through virtual signaling to turn the Message Waiting Indicator (MWI) on a user's telephone on and off. Virtual signaling is also used to transport necessary call information for a networking voice message feature, such as Call Sender. These calls are supported by using ISDN noncall-associated transaction signaling messages.

## Prime switch location and Meridian Application Server

The Meridian Application Server (MAS) is connected to the prime switch with two connections, one for voice and one for data. The Meridian Application Server communicates with the prime switch using the Application Module Link (AML) protocol. If the AML link fails, NMS calls are routed to the default ACD DN configured for the CDN (DFDN).

**Note:** AML was previously known as Command and Status Link (CSL) and Integrated Services Digital Network/Applications Protocol link (ISDN/AP).

# NMS and users

## Introduction

NMS is designed to be transparent to users. Users on one switch use the messaging system in the same way as users on all other switches and have access to the same features.

The only time NMS is not transparent is when a desktop user logs on to the system.

## Desktop user logon

When desktop users at non-NMS sites log on to CallPilot, they enter their mailbox number and their password only.

However, the first time desktop users at NMS sites log on to the system, they must also select their location name from a drop-down list. The location name is the name assigned to their switch location.

After the first logon, the selected location name becomes the default.



# NMS access mechanisms

## Introduction

Three accessing mechanisms provide access to NMS services:

- direct access
- indirect access
- offnet access

## Direct access

The direct access offered to NMS users mirrors CallPilot direct access on other networking solutions.

Direct access is initiated by a user dialing an NMS directory number, either by switch or network, or by pressing the Message Waiting key. Auto-logout on NMS is supported if the call is initiated from the user's station.

For a direct access call, the call is presented to CallPilot at the prime switch through direct switches. This is a basic ISDN call that requires noncall-associated ISDN Q.931 messages.

However, to support NMS features that require transaction signaling to transport the noncall-associated information, such as Message Waiting Indicator notification and the Call Sender feature, the configuration between the originating switch and the prime switch must support the NMS transaction signaling transport. If the path used to transport the noncall-associated messages is relayed through a switch that does not support NMS transaction signaling, NMS is not supported.

## Indirect access

Indirect access is initiated when a call is presented to NMS through call redirection.

For any call redirected to NMS, the original called number from the ISDN Q.931 SETUP message is extracted when the call is forwarded to the prime switch. It is then passed to the Meridian Application Server. This allows CallPilot to distinguish the address of the original called party.

For a redirected network call, NMS uses the Network Call Redirection (NCRD) feature to provide the original called number. The following Network Call Redirection types are supported:

- network call forward all calls (NCFAC)
- network call forward no answer (NCFNA)
- network call forward busy (NCFB)
- network hunting (NHUNT)

Indirect access requires the same NMS transaction signaling message.

## Offnet access

NMS supports two types of offnet access.

A user can directly dial in to the prime switch where the Meridian Application Server resides.

A user can dial in to the user's own switch to access a remote Meridian Application Server. For this type of offnet access, the user's switch may need to support direct inward system access (DISA). This allows the user to dial another network location after dialing in to the user's own switch.

# NMS features and considerations

## Introduction

All CallPilot features are available to users in an NMS network.

## NMS features

The following table lists the CallPilot features that are supported by NMS:

<b>CallPilot feature</b>	<b>Supported</b>
Call Sender	Yes
Names Across the Network	No
Name Addressing	Yes
Name Dialing	Yes
Personal Distribution Lists	Yes
Shared Distribution Lists	Yes
Multiple Recipients	Yes
Reply To (compose messages)	Yes
Reply All (reply to call answering messages)	Yes
User's Actual Personal Verification	Yes
Administrator-Recorded Personal Verification	Yes
Remote Site Spoken Names	Yes
Private Tag	Yes
Acknowledgment Tag	Yes
Urgent Tag	Yes
Received Time Announced	Yes

---

<b>CallPilot feature</b>	<b>Supported</b>
Sent Time Announced	Yes
99-Minute Messages	Yes
Sender's Name (text)	Yes
Recipient's Name (text)	Yes
Message Subject (text)	Yes
Sender's Department	Yes
Deferred Delivery	Yes

---

## **General considerations**

The prime switch must be a Meridian 1 (Release 23C) switch.

Satellite switches must be either Meridian 1 switches or other compliant switches.

### **Capacity**

A Meridian Application Server can support one prime switch and a maximum of 59 satellite switches.

## **Signaling limitations**

NMS is affected by several signaling limitations.

### **ISDN signaling limitations**

NMS uses the signaling capabilities of the ISDN primary rate access (PRA) and the ISDN signaling link (ISL) to provide networking customers with messaging services. Therefore, if a non-PRA or non-ISL trunk is involved in an NMS call, the call cannot be completed.

### Virtual signaling limitations

The prime switch and the satellite switches use virtual signaling to

- Turn the Message Waiting Indicator (MWI) on and off.
- Transport necessary call information for a networked multimedia messaging feature, such as Call Sender.

Virtual signaling is supported using ISDN noncall-associated transaction signaling messages. The FACILITY message with the TCAP protocol is used to transport information across the ISDN network.

### End-to-end signaling limitations

End-to-end signaling (EES) is required to access CallPilot features from a satellite switch.

## Dialing plans

NMS requires one of the following types of dialing plans:

- Electronic Switched Network (ESN)
- Coordinated Dialing Plan (CDP)
- hybrid, which is a combination of ESN and CDP

**Note:** NMS does not support another dialing plan, such as public switched telephone network (PSTN).

## Message center directory number

Only one message center directory number can be defined on each user telephone.

## Local messaging server broadcast

NMS interprets a local messaging server message broadcast to include users on all switch locations in the NMS network.

This feature is especially useful if, for example, you want to inform users of a server shutdown.

Broadcast messages are not delivered to mailboxes that are configured to refuse them. To avoid excessive resource usage, non-delivery notifications are not generated for broadcast messages.

## Message transmission times

There are no message transmission times among switch locations, because NMS does not transmit messages among switch locations.

Every user on each switch is added as a mailbox user on the Meridian Application Server. The server functions as the message center of NMS. When a message is sent to more than one user, the message is deposited directly into each user's mailbox. There is no transmission to a satellite switch location.

# Feature interaction

## Introduction

Many switch features interact with NMS. The following features interact with ISDN Network Call Redirection (NCRD):

- Call Forward (Unconditional, No Answer, and Busy)
- Network Call Transfer
- Network Hunting
- Call Forward by Call Type Allowed to a Network DN
- Attendant Extended Call
- Call from CO Loop Start
- Conference Call
- Barge-in Attendant

## Call Forward (Unconditional Call Forward, Call Forward No Answer, Call Forward Busy)

All three types of Call Forward are supported by the ISDN Network Call Redirection features. These are the basis for NMS indirect access.

In the case of an indirect NMS access call, the original called number and the redirecting reason are extracted from the original called number information element in the PRA SETUP message. The original called number and the redirected reason are put into the AML PCI message when presenting a call to the Meridian Application Server.

If the original called number information element is not present, the redirecting information element is used instead. Similarly, the redirecting number and reason are extracted and transported to the server through a PCI message.

## Network Call Transfer

Network Call Transfer is supported by the ISDN Network Call Redirection feature. If an NMS location is involved in a Network Call Transfer scenario, the connected party number is extracted from the PRA NOTIFY message and put into the AML DNP message when the transfer is complete.

The DN update message informs CallPilot that a call transfer has occurred.

## Network Hunting

Network Hunting is supported by the ISDN Network Call Redirection feature. Indirect NMS access can be presented to CallPilot through Network Hunting. The messaging is the same as for Call Forward Busy. Therefore, the original called number information element in the PRA SETUP message is used to construct the ISDN/AP PCI message.

## Call Forward by Call Type Allowed to a Network DN

The definition of the Call Forward by Call Type Allowed class of service is changed by the ISDN Network Call Redirection feature. This means that private network calls are treated as internal calls and are forwarded, using the Call Forward No Answer feature or the Network Hunting feature, to the Flexible Directory Number or Hunt DN rather than to the External Flexible Number or External Hunt DN.

The Call Forward feature is implemented through the ISDN Network Call Redirection feature. With this feature, the switch is able to provide different messaging treatments for different types of calls, such as off-net calls instead of on-net calls.

A location can be configured so that all off-net calls are handled by a centralized attendant, while internal calls are handled by CallPilot. However, there is a limit of one message center DN for each location. This means that a user can be served by two message centers, one that handles internal calls and one that handles external calls, but only one can control the Message Waiting Indicator (MWI) activation.



## Attendant Extended Call

Attendant Extended Call has an impact that is similar to Network Call Transfer. There is one important difference, however. The DN update message is sent to CallPilot when the attendant releases the call. Therefore, the connected party number is updated only when the attendant is released.

## Call from CO Loop Start

Calls that come in to the switch from the CO Loop Start trunk cannot be redirected to another trunk through attendant extension or call redirection. These calls should be blocked when redirection is activated.

The ISDN Network Call Redirection feature does not redirect calls from CO Loop Start. Therefore, NMS does not support these calls.

## Conference Call

When another party has a conference call with a CallPilot system, a DN update message is sent indicating a conference call type. The connected party DN is the same as the station initiating the conference call, which is always the same as the DN in the PCI message.

If additional parties are added to the conference, no additional DNP messages must be sent.

When a conference call drops back to a simple call, a DNP message is sent indicating a simple call as call type and showing the remaining party as the connected DN.

When the conference is established and is dropped at a satellite switch, a FACILITY message with TCAP protocol is transported to notify the prime switch of the conference call activities.

The DNP message is then triggered and sent to the Meridian Application Server.

## Barge-in Attendant

The attendant can barge in on an NMS call on the prime switch location. During barge-in, users cannot use the features that require switch effort, such as Call Sender.



# Dialing plans and NMS

## In this section

<a href="#">Overview</a>	76
<a href="#">Dialing plans and NMS user locations</a>	77
<a href="#">NMS dialing restriction scenarios</a>	80

# Overview

## Introduction

The dialing plan that connects the switch locations in a NMS network is fundamental to NMS.

NMS supports the following dialing plans:

- Electronic Switched Network (ESN)
- Coordinated Dialing Plan (CDP)
- hybrid, which is a combination of ESN and CDP

**Note:** NMS does not support another dialing plan, such as PSTN.

## Why dialing plans are important

It is important to understand how dialing plans work, because the dialing plan used can affect the way your NMS network is implemented. As well, if the dialing plan is set up incorrectly, NMS cannot work.

The dialing plan can also affect the configuration of the switch locations.

## See also

The following discussion assumes that you are familiar with the basic concepts of dialing plans. For a review of these concepts, consult the *Networking Planning Guide*.

# Dialing plans and NMS user locations

## Introduction

The dialing plan used can affect the flexibility of configuring the user locations in an NMS network.

## User location

A user location is a logical grouping of mailboxes. A user location may be the mailboxes on one switch or the mailboxes on two or more switches.

## ESN dialing plan

If the ESN dialing plan is used, there must be a one-to-one correspondence of switch locations to user locations.

## CDP dialing plan

If the CDP dialing plan is used, there are two ways to define the correspondence of switch locations to user locations:

- a one-to-one correspondence
- an all-to-one correspondence

### **Define one switch location as one user location**

Typically, each switch location is represented by a user location.

If this is done, ensure that there are no conflicts. For example, the same extension cannot exist on two different switch locations.

The following diagram shows a one-to-one correspondence between switch locations and user locations.

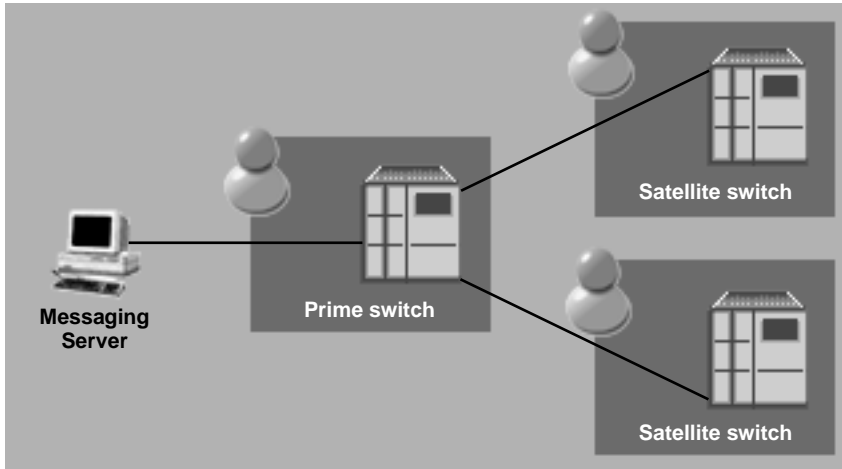

G100987.eps

### Define two or more switch locations as one user location

By defining two or more switch locations as one user location, you do not have to check for conflicts. This option also allows you to maximize the number of users supported.

You can combine all switch locations into one user location, or you can combine some switch locations into one user location.

Defining one user location offers the following advantages:

- Configuration of satellite switch locations is simplified.
- Configuration of phantom DN's for services at all locations is simplified.

However, defining one user location has the following disadvantage:

- The spoken name for each individual location is lost.

In the following diagram, two switch locations are combined into one user location.

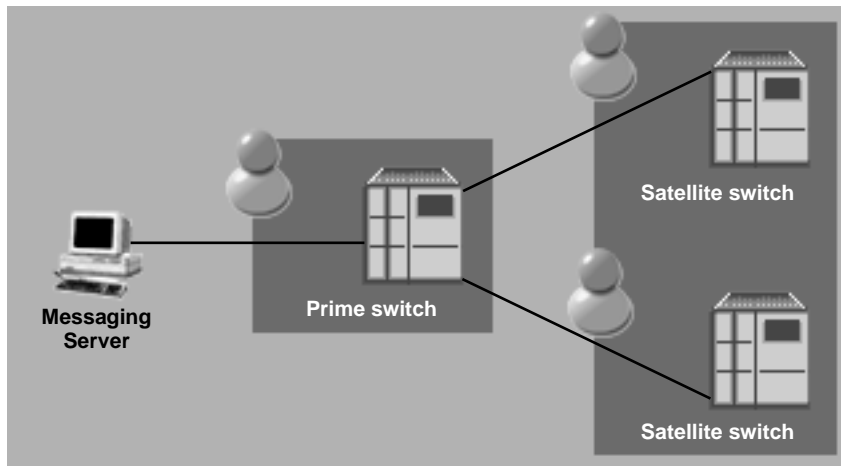

G100988.eps

## How two or more switch locations are combined into one user location

When implementing NMS, if each switch location is a user location, on CallPilot you add and configure each satellite switch. However, each switch is configured individually.

To combine two or more switch locations into a single user location, you add and configure only one satellite switch location. The CDP steering codes for the switch locations are added to a single list.

### Restriction

A switch location can have a maximum of 500 CDP steering codes. If, by defining a single user location, you require more than 500 CDP steering codes, you cannot use this option.

# NMS dialing restriction scenarios

## Introduction

An NMS network requires a uniform dialing plan. This requirement has important implications for implementing an NMS network. In some cases, it may require reconfiguration of an existing dialing plan.

## Uniform dialing plan

The uniform dialing plan requirement must be considered in the following scenarios:

- calls to other users in the NMS network
- calls to other users at other sites in the private messaging network but not part of the local NMS site
- calls to public switched telephone network (PSTN) users beyond the private messaging network

## Dialing restrictions for calls within an NMS network

Dialing among all users on all switches in an NMS network must be done uniformly. The only exception is that the ESN access code may be different.

## Dialing restrictions for calls within a private messaging network

A uniform dialing plan is also necessary when an NMS network is a site in a larger private messaging network.

Dialing from all users on all switches in an NMS network to a remote site in the private network must be completed uniformly. The only exception is that the ESN code may be different.



## Dialing restrictions for calls beyond the private messaging network

A uniform dialing plan is also necessary to make calls from an NMS network to PSTN users.

Dialing from all users on all switches in an NMS network to a PSTN site, which is not part of the private network, must be completed uniformly. The only exception is that the ESN code may be different.

## Implications of the dialing restriction for calls beyond the private network

The uniform dialing plan restriction has important implications that must be considered when implementing an NMS network.

For all switches in an NMS network to dial PSTN destinations in the same way,

- All switches in the NMS network must be located in the same city/area code.
- All switches must be located in proximity to one another (that is, within the same PSTN local calling area).
- All switches must use the same prefixes to reach the PSTN.

If these requirements are not satisfied, when a user on a satellite switch in the NMS network dials a PSTN destination using features such as Thru-Dial, Call Sender, and Remote Notification, the message may not be delivered. This is because, although the call is made at a satellite switch location, the call is actually dialed from the prime switch location.

These implications do not affect users on the prime switch location.

**Note:** While CallPilot is supported, calls may not work.

### **All switches must be located in the same city/area code**

Switches in different city/area codes cause problems.

**Example:** Switch A is the 416 city/area code and switch B is in the 905 city/area code. To dial from switch A to (416)597-1234, a user dials 95971234. However, a user on switch B must dial 914165971234.

### **All switches must be in the same calling area**

Numbers that require different dialing from different switches cause problems.

**Example:** To reach the PSTN number (905)555-1234, a user on switch A can dial 919055551234. A user on switch B, however, can dial only 95551234. Because the switches have different local and long-distance dialing areas and use different dialing formats to reach the same PSTN number, the dialing plan is not uniform.

### **All switches must use the same prefixes to reach the PSTN**

Switches that do not use the same prefixes to reach the PSTN may cause problems.

**Example:** All switches in the NMS network must use the same local, long-distance, and international dialing prefixes. If users on switch A dial 61 for long distance and users on switch B dial 71, the dialing plan is not uniform.

## **CDP dialing plan restriction**

If a CDP dialing plan is used, the CDP code must overlap the mailbox number sufficiently.

## **Hybrid dialing plan requirements**

If a hybrid dialing plan is implemented in the NMS network, the following requirements must be met:

- All switches must support ESN and have ESN prefixes.
- The prime switch must support both ESN and CDP.
- CDP can exist on any satellite switches.
- The general restrictions that apply to CDP also apply to CDP when used in a hybrid dialing plan.

### **Considerations**

If all CDP switches share the same ESN prefix, configure the prime switch to represent all of the switches that are part of CDP.

If each CDP switch has its own ESN prefix, or prefixes, create a location for each ESN switch in the network. That is, group the switches by ESN prefixes.

# Implementing NMS

## In this section

<a href="#">Overview</a>	84
<a href="#">Gather information</a>	85
<a href="#">Configure the satellite switches</a>	86
<a href="#">NMS network configuration</a>	87
<a href="#">NMS site configuration</a>	89

# Overview

## Introduction

Successful implementation of NMS requires planning and preparation. A plan that specifies the objectives and functionality of the networking implementation is important.

Before you begin to implement NMS, you should understand the basic implementation process and what you are expected to do.

All steps in the implementation process are described in more detail in the following chapters.

## Before you begin

NMS is an incremental installation onto your CallPilot system.

This guide assumes that the following preliminary requirements are met:

- The prime switch is installed and configured.
- The satellite switches are installed and configured.
- CallPilot is installed and configured, except for NMS.
- Sufficient trunks connecting the prime switch to a public switch are available.
- If the implementation is an upgrade from Meridian Mail, all legacy information is available.

## Implementation process

The main steps in the implementation process are

- gathering information ([Chapter 3, Gathering information](#))
- configuring the switch locations ([Chapter 4, Configuring the switches](#))
- configuring CallPilot on the Meridian Application Server ([Chapter 5, Configuring CallPilot for NMS](#))
- testing and backing up the system ([Chapter 6, Testing and backing up NMS](#))

# Gather information

## Introduction

Before you implement NMS, you must understand how the network will work and how users will dial one another.

## If the implementation is an upgrade

If CallPilot NMS is an upgrade from an existing NMS setup or is being added to an existing site, information must be gathered about the existing site. Whenever possible, the information will be reused so that the implementation of CallPilot NMS will be transparent to users, and they will continue to use the system as they always have.

## If the implementation is a new network

If NMS is a new implementation, this information must be created. Information about the administrative setup should be gathered first so that there are no conflicts. For example, prefixes used to dial an exterior number, a long-distance number, or an international call should be gathered.

Much of the required information depends on the dialing plan that will be used. If CallPilot NMS is replacing a current system, usually the existing dialing plan will be re-created. If CallPilot is a new implementation, the choice of dialing plan depends on how the system will be used.

## Recommendation

An ESN dialing plan is recommended over a CDP dialing plan.

An ESN dialing plan has several advantages, including the following:

- easier to maintain
- easier to add new sites
- minimal conflicts with numbering plans

# Configure the satellite switches

## Introduction

Although all satellite switches must be installed and configured before you begin to implement NMS, you must make additional changes to the satellite switch configurations.

## Satellite switches must forward to the prime switch

Phantom directory numbers (DNs) have been set up on the prime switch. These phantom DNs are used by the switch to route calls to services. Phantom DNs forward incoming calls to the appropriate CDN queues on the prime switch for further call handling.

By creating a phantom DN for CallPilot services, every service has a unique number that users dial. Some services, such as Integrated Voice and Fax, may be configured to use the CDN numbers directly.

To make the services that are available to users on the prime switch available to users on the satellite switches, the phantom DNs on the satellite switches must be configured to forward to the ACD queues on the satellite switch. In turn, the ACD queues on the satellite switch forward to the CDN queues on the prime switch.

## Phantom DNs and NMS

To access a CallPilot service, a user enters a unique dialable number. The switch uses this number to begin routing the call to the requested service.

The call is routed to ACD queues on the satellite switches and then to CDN queues on the prime switch location.

## Determine the CDN queues on the prime switch

You must know the CDNs used on the prime switch to configure the phantom DNs and ACD queues on the satellite switches.

Ask the switch technician responsible for configuring the prime switch location for this information.

# NMS network configuration

## Introduction

NMS configuration consists of adding information about the Meridian Application Server, the prime switch location, and all satellite switch locations to the database.

## Prime switch location configuration

When you configure the prime switch location for NMS, you complete the required information on the Messaging Network Configuration—Local Prime Switch dialog box.

Configuration consists of providing general information about the switch location, such as name and server type, as well as detailed information about the dialing plan used.

## Satellite switch location configuration

When you configure a satellite switch location, you complete the required information on the Messaging Network Configuration—Satellite Switch dialog box.

Configuration consists of providing general information about the switch location, such as name and server type, as well as detailed information about the dialing plan used.

You must also configure the phantom DN and ACD queues on the satellite switch locations.

After adding a phantom DN for a satellite switch, you must add an entry to the SDN Table on the prime switch location.

## Meridian Application Server configuration

There are two main steps to configuring the Meridian Application Server:

- adding and configuring inbound SDNs for all services provided by all switch locations
- configuring the messaging network configuration information

## **SDNs**

Although the Service Directory Number (SDN) Table on the Meridian Application Server is already set up and configured, you must make additions to the table for NMS after configuring the phantom DNs and ACD queues on the satellite switch locations.

## **Messaging Network Configuration**

Configure the local Meridian Application Server for NMS by completing the required information on the Messaging Network Configuration—Local Server dialog box.

## **Test and back up the system**

Test the NMS network to ensure that the system is properly configured and is sending messages as expected.

After the system is tested, perform a backup. The backup ensures that the proper configuration is not lost in the event of a system failure.

## **See also**

If you require additional information about the general implementation process, consult the *Networking Planning Guide*.



# NMS site configuration

## Introduction

If the NMS network is a site in a larger messaging network, it is called an NMS site.

The first steps in configuring of an NMS site are the same as those for configuring an NMS network. In fact, first you set up an NMS network, and then you add it to the messaging network as a site, specifying the protocol or protocols that the NMS site uses to communicate with other sites in the messaging network.

## Recommendation

Plan the entire messaging network before configuration to ensure that there are no conflicts with any other sites in the messaging network.

### Example

The following example illustrates two NMS sites, Site 5 and Site 6, in a messaging network. In this example, suppose you are the administrator of Site 6. In addition to NMS, you know that you are implementing Enterprise Networking, AMIS Networking, and Integrated AMIS Networking on your system. You know which sites you will communicate with using each protocol.

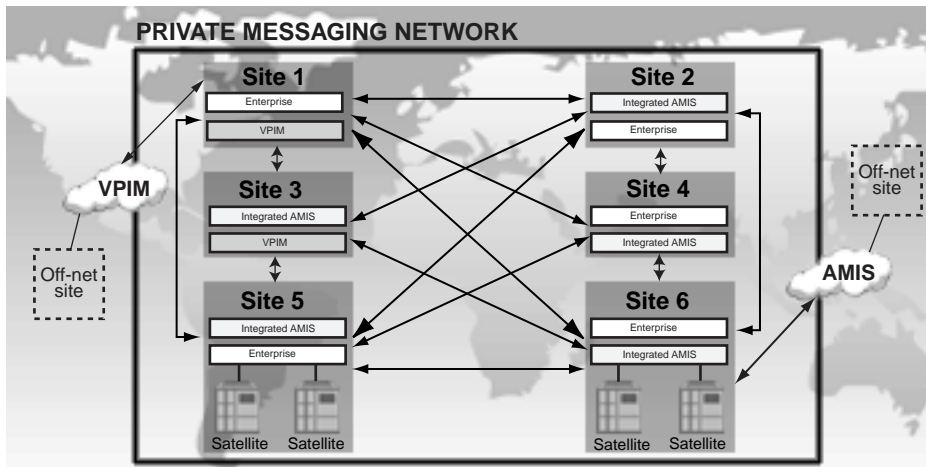

G101139.ej

You begin by implementing NMS on Site 6. Once completely implemented and tested, you provide all details of the configuration to the administrators of the remote sites as part of a general information-sharing and -gathering process.

The network administrator at Site 5 also implements and tests NMS.

When both Site 5 and Site 6 have NMS implemented, configuration information is shared with all other sites in the messaging network.

Only after the NMS network implementation is complete and all the required information is gathered can you begin to implement the other networking solutions.

## chapter 3

---

# Gathering information

This chapter describes how to gather the information that is required to implement NMS.

The chapter also describes how to create a representation of the NMS network.

### In this chapter

<a href="#">Required information</a>	93
<a href="#">NMS network representation</a>	95



# Required information

## Introduction

Before you begin to implement NMS, gather the information that is required to configure the system.

This information specifies how the switches in the NMS network communicate.

## Required information

Information is required from the prime switch location and each satellite switch location.

### Prime switch location information

The following information is required:

- switch location name
- dialing plan used
  - ESN
  - CDP
  - hybrid, combining ESN and CDP
- dialing plan information
  - ESN dialing plan:
    - ESN access codes
    - number of overlapping digits between ESN prefix and local extension
    - ESN prefix, including the access code
  - CDP dialing plan:
    - number of overlapping digits between CDN steering code and local extension
    - CDP steering code
  - hybrid dialing plan, combining ESN and CDP dialing plans
- extension numbers used (necessary to avoid conflicts with any codes and prefixes used)
- information about existing CDNs and phantom DNS defined on the switch

### **Satellite switch location information**

The following information is required:

- switch location name and number
- dialing plan used
  - ESN
  - CDP
  - hybrid, combining ESN and CDP
- dialing plan information
  - ESN dialing plan:
    - ESN access codes
    - number of overlapping digits between ESN prefix and local extension
    - ESN prefix, including the access code
  - CDP dialing plan:
    - number of overlapping digits between CDN steering code and local extension
    - CDP steering code
  - hybrid dialing plan, combining ESN and CDP dialing plans
- extension numbers used (necessary to avoid conflicts with any codes and prefixes used)
- information about existing phantom DNs and dummy ACD queues defined on the switch

# NMS network representation

## Introduction

A representation of the NMS network summarizes how the NMS network is set up. It contains information about each of the switch locations and the Meridian Application Server, and indicates the relationships among them.

If sufficiently detailed, a representation of the NMS network is the primary source of information consulted during implementation.

For most NMS networks, a diagram is the most suitable form of representation. For a very large NMS network, however, a spreadsheet is more appropriate.

## Purpose

A detailed diagram or spreadsheet is useful because it contains all of the information you require to implement NMS. During implementation, you enter information from the representation into the network database.

In many ways, the representation is your implementation blueprint.

## Benefits

There are many benefits to creating a representation of your messaging network. A representation

- offers a clear view of how your network is connected
- provides an opportunity to determine if there are any conflicts
- gathers all required information in one place
- provides useful information when planning future modifications
- helps during the analysis of traffic issues
- reveals areas where the network could be improved
- provides support personnel with a concise, clear view of the network

### Sample NMS diagram

The following diagram illustrates a simple NMS network. The dialing plan is CDP. Each switch location is defined as a distinct user location.

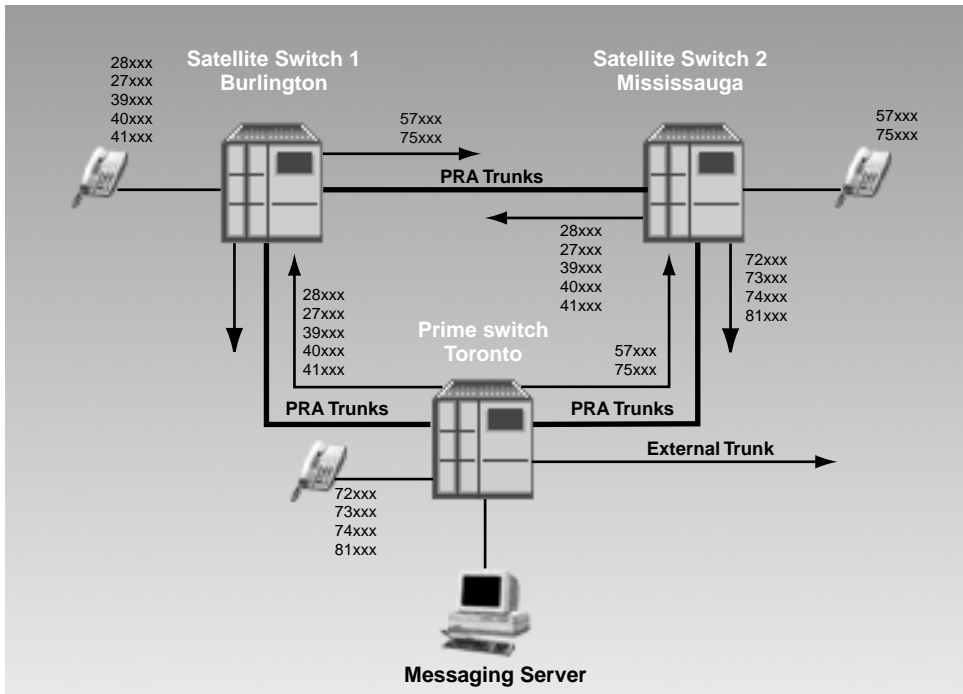

G100989.eps

### Protecting the representation

Your network representation contains sensitive information. It should be properly stored and protected as part of normal security procedures.

### See also

For more information on creating network diagrams, consult the *Networking Planning Guide*.



## chapter 4

---

# Configuring the switches

This chapter describes how the prime switch location and the satellite switch locations are configured to implement NMS.

The chapter introduces the concepts that are necessary to understand the configuration process and provides detailed configuration procedures.

### In this chapter

<a href="#">About switch configuration</a>	99
<a href="#">Configuring the switch locations</a>	103



# About switch configuration

## In this section

<a href="#">Switches and NMS</a>	100
<a href="#">Confirming the Network Class of Service</a>	101

# Switches and NMS

## Introduction

Switches provide the call handling required by CallPilot.

All switches that are used by NMS are already configured and tested when you begin to implement NMS.

However, you must check this configuration to determine if it is suitable for NMS. You must also do additional configuration to enable functionality that is required by NMS.

# Confirming the Network Class of Service

## Introduction

On each switch location in the NMS network, confirm that the Network Class of Service (NCOS) level is adequate for NMS.

If an NCOS level is inadequate, NMS may not work.

## Definition: Network Class of Service

A Network Class of Service level is a switch setting that controls access to trunks and call queuing. It also provides users with expensive route warning tones.

### NCOS and NMS

NMS requires that the system be able to dial within the NMS network.

Therefore, ensure that the NCOS level is sufficient to support a CallPilot system with all features.

The NCOS level must allow the system to dial out of a switch location for Call Sender and Thru-Dial, but not create possible security breaches.

## See also

For detailed information about NCOS levels, including how to check their current setting and make adjustments if required, refer to your switch documentation.



# Configuring the switch locations

## In this section

<a href="#">Overview</a>	104
<a href="#">Dummy ACD-DNs on satellite switch locations</a>	106
<a href="#">Phantom DNs and SDNs in an NMS network</a>	107
<a href="#">Switch overlays</a>	110
<a href="#">Prime switch configuration</a>	111
<a href="#">Configuring satellite switch locations</a>	113
<a href="#">Configuring telephones of users on satellite switch locations</a>	117
<a href="#">Upgrade an existing satellite switch</a>	118
<a href="#">SDN Table and NMS</a>	119
<a href="#">Services not in the SDN Table</a>	122
<a href="#">Adding and configuring SDNs in the SDN Table</a>	123

# Overview

## Introduction

NMS provides the same CallPilot services to users on satellite switches that are available to users on the prime switch. NMS provides these services transparently. That is, users receive the same services without having to enter any additional numbers, regardless of which switch they are on.

To provide these services, the switches and the server in the NMS network must be carefully configured.

Configuring the prime switch location and the satellite switch locations is a major step in implementing an NMS network.

## Skill requirements

Configuring switches for NMS should be done by an experienced switch technician.

## Assumptions

This guide assumes that you have a basic understanding of how the prime switch is set up and how it interacts with the server to provide requested services.

You should understand the following terms:

- service directory numbers (SDNs)
- controlled directory numbers (CDNs)
- phantom directory numbers (phantom DNs)

For a review of these concepts, consult the relevant sections in the *Advanced Administration Guide*.



## Before you begin

Implementing NMS is an incremental process.

Before you begin to configure the switches in your NMS network, the following should be complete:

- The Meridian Application Server is installed and configured. The SDN Table contains all local SDNs.
- The prime switch location is installed and configured. The CDNs and the phantom DNs are set up.
- The satellite switch locations are installed and configured. However, the phantom DNs and the dummy ACD-DNs must be set up.
- Adequate trunks are installed on all switch locations.

## Administrator cooperation

Configuring the switch locations in an NMS network requires cooperation among the administrators of all switch locations.

The following process is recommended:

- Gather the required information from the prime switch.
- Configure each satellite switch based on the gathered information.
- Complete the configuration of the SDN Table on the messaging server.

## See also

For a general discussion of phantom DNs, SDN Tables, and how switches must be configured for CallPilot, consult the relevant sections in the *Advanced Administration Guide*.

# Dummy ACD-DNs on satellite switch locations

## Introduction

CDNs exist on the prime switch only. Satellite switch locations have dummy ACD-DNs.

A dummy ACD-DN forwards a request for a service by a user on the satellite switch location to a CDN on the prime switch.

To provide the service, a dummy ACD-DN forwards the request through a night call forward (NCFW) DN. The NCFW DN determines the CDN to which calls are routed.

## Number of dummy ACD-DNs required

The number of dummy ACD-DNs on a satellite switch location must be the same as the number of CDNs on the prime switch.

For example, if there are two CDNs on the prime switch, one for voice and one for fax, there must be two dummy ACD-DNs on each satellite switch location, one for voice and one for fax.

# Phantom DNs and SDNs in an NMS network

## Introduction

You must understand how the switch locations handle messages to understand the switch configuration that is required for NMS.

All switch locations in an NMS network have phantom directory numbers (DNs).

The phantom DNs of satellite switch locations are configured differently from the phantom DNs of the prime switch location.

## Interrelationships

The following diagram illustrates the relationship among the phantom DNs on a satellite switch location, the dummy ACD-DNs on a satellite switch location, the CDNs on a prime switch location, and the SDN Table.

The phantom DNs of the prime switch location are set up before you begin to implement NMS. Information about the configuration is required to set up the phantom DNs on the satellite switch locations. The SDN Table already exists on the messaging server. You add additional entries to the table for the services provided on each of the satellite switch locations.

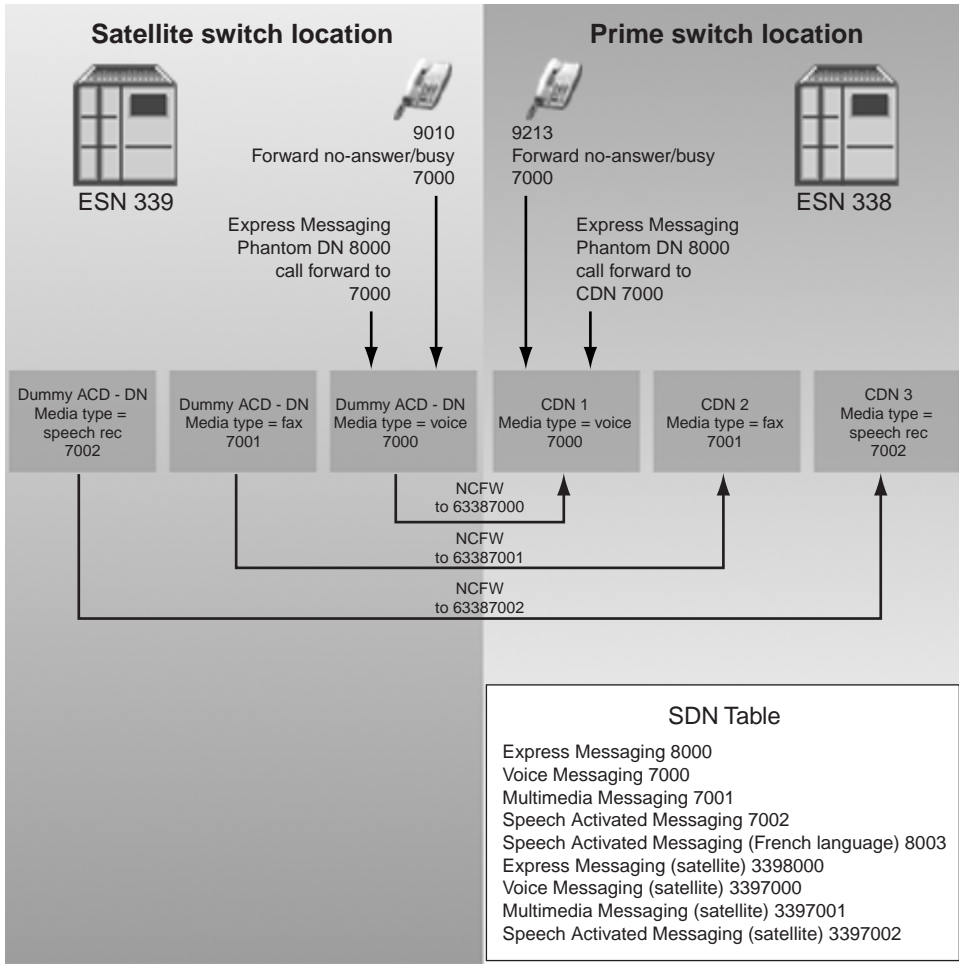

G100965.eps

## Satellite switch location phantom DNs

The phantom DNs of the satellite switch location are separately defined on the satellite switch.

This allows users on the satellite switch to dial a local number rather than using the prime switch phantom DNs with a prefix. For example, a user enters 63388000 for Express Messaging.

In this diagram, the phantom DNs of the satellite switch location are set up so that users on any switch location can use the same digits to access the service. However, this is not a requirement. Different phantom DNs and dummy ACD queue numbers can be used on the satellite switch as long as the corresponding network numbers are entered in the SDN Table.

## SDN Table

The SDN Table on the messaging server contains the SDNs that correspond to the phantom DNs, CDNs, and dummy ACD queues of both the satellite switch locations and the prime switch location.

The number dialed is used to locate the requested service. In the diagram, the 3397000 matches the Voice Messaging Service for the satellite switch location. A user on a satellite switch dials 7000 to reach the service, but the SDN configuration must contain the number in the network format as seen by the prime switch (for example, 3397000).

The SDN is the dialable number that provides the service to the user on the satellite switch location.

### Satellite switch location SDNs

The dialing plan prefix distinguishes the SDNs for satellite switch locations from the SDNs for the prime switch location.

If an ESN dialing plan is used, the satellite switch location SDN entries do not include the ESN access code. Only the location code is required.

**Example:** If the ESN access code is 6, the location code is 339, and the DN is 8000, enter 3398000 for the service in the SDN Table.

# Switch overlays

## Introduction

Satellite switch locations for NMS are configured on the following overlays:

Task	Overlay
Define a dummy ACD-DN.	23
Configure a phantom DN.	10

## Responses to overlay prompts

To program an overlay, you respond to a series of prompts. The procedures in this section mention only those prompts that are relevant to NMS. You must respond to these prompts in a certain way.

Any prompt that is not mentioned can be programmed in any way. To accept the default value for other prompts, press Enter.

When working with overlays, follow the general steps below.

## To work with overlays

- 1 Load the appropriate overlay.
- 2 Respond to prompts as shown in the tables in this section.
- 3 Press Enter after each prompt until you get to the next one to be defined.
- 4 When configuration is complete, enter \*\*\*\* in response to the REQ prompt.

**Result:** You exit the overlay.

# Prime switch configuration

## Introduction

The prime switch provides the call handling services required by NMS. All requests for services from the satellite switch locations are forwarded to the prime switch location.

The configuration of a satellite switch location must be coordinated with the configuration of the prime switch location. Gather configuration information from the prime switch location before configuring a satellite switch location.

## Required information

You must gather complete details of the configuration of the CDNs and phantom DNs on the prime switch location. This information is used to configure a satellite switch location.

## Phantom DNs

While some services are accessed by directly dialing a CDN, many services are accessed by dialing a phantom DN.

A phantom DN forwards incoming calls to a controlled directory number (CDN) for further call handling. A phantom DN is created for each service offered by the switch. This ensures that each CallPilot service has a unique number that users dial.

### Example

A user dials 8000 to access Express Messaging and 7040 to access Fax Item Maintenance. Phantom DNs must exist for both services.

## Determine the CDNs and the phantom DNs on the prime switch

You must know the CDNs and the phantom DNs used on the prime switch to configure the phantom DNs on the satellite switches.

Ask the switch technician for a complete list of the CDNs and the phantom DNs, as well as the services they provide.

## **Coordinate with the administrators of satellite switches**

The administrators of the satellite switches must know the phantom DNs used on the prime switch.

Ensure that every administrator has a complete and accurate list of the phantom DNs and the services they provide.

## **See also**

For detailed information about phantom DNs and how a switch must be configured for CallPilot, consult the relevant sections in the *Advanced Administration Guide*.



# Configuring satellite switch locations

## Introduction

Although the satellite switch locations are installed and set up before you implement NMS, some additional configuration is required.

The additional configuration consists of two main steps:

- Configure the dummy ACD-DNs to forward to the CDNs on the prime switch.
- Configure the phantom DNs to forward to the dummy ACD-DNs.

**Note:** The procedures that follow are for new satellite switch locations. If you are upgrading an existing satellite switch location, review the section [Upgrade an existing satellite switch](#) on page 118.

## Before you begin

You must know the CDNs and phantom DNs that are used on the prime switch location to configure the phantom DNs and dummy ACD-DNs on the satellite switch locations.

## Define the dummy ACD-DNs

Define a dummy ACD-DN for each media type used.

Usually, for each type of CDN on the prime switch, there is a corresponding dummy ACD-DN on the satellite switch.

<b>If this is on the prime switch</b>	<b>Then this is on a satellite switch</b>
CDN	Dummy ACD-DN
Media type: Voice	Media type: Voice
CDN	Dummy ACD-DN
Media type: Fax	Media type: Fax
CDN	Dummy ACD-DN
Media type: Speech recognition	Media type: Speech recognition

If a satellite switch does not provide any of the services provided by a type of CDN queue, it is not necessary to define a dummy ACD-DN. For example, if a satellite switch does not provide any speech recognition services, a speech recognition dummy ACD-DN is not required.

### Setting the dummy ACD-DNs to night call forward

Every dummy ACD-DN must be configured to night call forward to the corresponding CDN on the prime switch location.

The forwarding address must be in network format. For example, to night call forward to 63387000,

- ESN access code = 6
- Location code of prime switch = 338
- Voice CDN on prime switch = 7000

By configuring night call forwarding in this way, users on the satellite switch location can access the CallPilot service by entering the local satellite switch ACD queue number, 7000. They do not have to explicitly dial the CDN on the prime switch location.

### To define a dummy ACD-DN on a satellite switch

- 1 Load overlay 23.
- 2 For each prompt listed in the following table, enter the response indicated. For prompts that are not listed, click Enter to accept the default.

Prompt	Response	Description
REQ	NEW	Indicates creation of a new DN
TYPE	ACD	
CUST	0	
ACDN	x...x	For example, 7000 <ul style="list-style-type: none"> <li>■ 7 digits maximum length</li> </ul>
MWC	YES	Indicates this is a message center DN

Prompt	Response	Description
MAXP	1	Even though there is no agent for this DN, one is required
NCFW	x...x	Night call forwarded DN <ul style="list-style-type: none"> <li>■ up to 31 digits, network number of CDN on the prime switch</li> </ul>
<b>3</b>	To define another dummy ACD-DN, at the REQ prompt enter <b>YES</b> .	
<b>4</b>	To exit the overlay, enter ****.	

## Phantom DNs

Add phantom DNs for services that you want available at that satellite switch location.

**Note:** You can add additional phantom DNs to account for additional services that you plan to implement in the future.

## Add phantom DNs

For detailed instructions on how to add a phantom DN to a satellite switch location, consult the *Advanced Administration Guide*. The procedures for entering phantom DNs on the prime switch are the same as the procedures for entering phantom DNs on a satellite switch.

## Forward phantom DNs

Every phantom DN that is added to a satellite switch location must be call forwarded to the dummy ACD-DN on a satellite switch.

## To forward a phantom DN

- 1 Load overlay 10.
- 2 Define the phantom DN to default call forward to the dummy ACD-DN. At the FTR prompt, enter **DCFW**, the number of digits in the default forward DN (only certain values are accepted), and the default DN.  
**Example:** FTR DCFW 4 7000 (where 7000 is the dummy ACD-DN on the satellite).
- 3 To exit the overlay when configuration is complete, enter \*\*\*\* at the REQ prompt.

# Configuring telephones of users on satellite switch locations

## Introduction

To configure a user's telephone on a satellite switch, you use a procedure similar to the one used on the prime switch. However, on a satellite switch, a dummy ACD-DN is used instead of a CDN.

The local ACD-DN is specified as the local forward DN and the Hunt DN for the user's phone. The same DN is also defined as the message center DN on the Message Waiting key.

### Example

- FDN 7000
- HUNT 7000
- KEY 8 MWK 7000

## To configure a telephone

- 1 Load overlay 11.
- 2 For each prompt listed in the following table, enter the response indicated. For prompts that are not listed, click Enter to accept the default.

Prompt	Response	Description
FDN	xxxx	ACD-DN (at the satellite switch) as forward-no-answer DN
HUNT	xxxx	Hunt to ACD-DN
KEY	8 MWK xxxx	ACD-DN as message center DN

- 3 To exit the overlay, enter \*\*\*\*.

# Upgrade an existing satellite switch

## Introduction

The configuration of satellite switches for NMS in CallPilot is different from the configuration for Meridian Mail.

Meridian Mail uses dummy ACD-DNs, rather than phantom DNs, to forward a call to another ACD-DN on a satellite switch. These ACD-DNs forward to ACD-DNs for Meridian Mail on the prime switch.

If you are upgrading an existing system, you must decide how you will configure the satellite switches. You can either reuse the existing legacy configuration or reconfigure the system.

## Continued use of ACD-DNs

To continue to use the dummy ACD-DNs instead of phantom DNs with CallPilot, make sure that the ACD-DN that is forwarded to is, in turn, configured to night call forward to the CDN on the prime switch, specified in network format.

For the procedures for night call forwarding the dummy ACD-DNs, consult the original switch documentation.

## Upgrade to phantom DNs

You can also upgrade the existing dummy ACD-DNs and replace them with phantom DNs.

To upgrade the system, follow the procedure in [Configuring satellite switch locations](#) on page 113.

Remove the unused dummy ACD-DNs.

# SDN Table and NMS

## Introduction

A Service Directory Number (SDN) Table already exists on the Meridian Application Server. It contains all of the SDNs required by the prime switch.

However, you must add entries to the SDN Table to satisfy the needs of the satellite switch locations. These additional entries are the services used at each of the satellite locations.

After all satellite switch locations are configured, their phantom DNs and dummy ACD-DNs must be added to the SDN Table.

## Definition: SDN

A service directory number (SDN) enables a user to access a CallPilot service. Each SDN must be unique so CallPilot can identify the requested service and play the appropriate prompts.

## SDNs and NMS

The services offered by the prime switch location must be available to the satellite switches. For this reason, SDNs corresponding to the services offered by the satellite switches must be added to the SDN Table.

## Inbound SDNs

In an NMS site, the satellite switch locations require only inbound SDNs. An inbound SDN is a directly dialable number used to access services.

## SDN Table

The SDN Table is created during the initial installation of CallPilot on the server. The SDN Table lists all SDNs and provides details about their settings.

CallPilot uses the SDN Table to map directory numbers (DNs) to services. The SDN Table lists both inbound and outbound SDNs.

### Example

The following SDN Table contains the SDNs for both the prime switch and a satellite switch. The satellite switch SDNs consist of two main parts: the same SDN used for the prime switch, and the location code of the satellite switch. In this example, an ESN dialing plan is used.

The screenshot shows a window titled "Service Directory Number - CallPilot on MAS Server - Toronto". The window contains a table with the following columns: Service DN, Application Name, Media Type, Minimum Channels, Maximum Channels, and Comments. The table lists various SDNs, including 4750 through 4765, 8899, and OUTBOUND10 through OUTBOUND9. The row for SDN 4765 is highlighted in blue and has a comment "Shared with AMIS & EN.". The status bar at the bottom indicates "14 Items" and "NUM".

Service DN	Application Name	Media Type	Minimum Channels	Maximum Channels	Comments
4750	Voice Messaging	Voice	0	Default Max.	
4751	Multimedia Messag...	Fax	0	Default Max.	
4763	Enterprise Network...	Voice	0	Default Max.	
4764	AMIS Networking	Voice	0	Default Max.	
4765	Fax Item Maintena...	Fax	0	Default Max.	Shared with AMIS & EN.
8899	Multimedia Messag...	Fax	0	Default Max.	
OUTBOUND10	AMIS Networking	Voice	0	Default Max.	
OUTBOUND11	Multimedia Messag...	Voice	0	Default Max.	
OUTBOUND15	Multimedia Messag...	Fax	0	Default Max.	
OUTBOUND18	Multimedia Messag...	Voice	0	Default Max.	
OUTBOUND6	Multimedia Messag...	Voice	0	Default Max.	
OUTBOUND7	Multimedia Messag...	Voice	0	Default Max.	
OUTBOUND8	Multimedia Messag...	Fax	0	Default Max.	
OUTBOUND9	Enterprise Network...	Voice	0	Default Max.	



## Satellite switch SDNs

The services provided on the satellite switches are entered in the SDN Table on the CallPilot server.

To enter a satellite switch SDN, you must know the phantom DNs and ACD-DNs that are set on the satellite switch, and the location codes of the switch in the dialing plan. Usually (for example, if an ESN dialing plan is used) the phantom DNs on the satellite switches are numbered the same as those on the prime switch.

For an example of satellite switch SDNs, see the diagram under [Phantom DNs and SDNs in an NMS network](#) on page 107.

## See also

For detailed information on SDNs and SDN Tables, consult the relevant sections in the *Advanced Administration Guide*.

# Services not in the SDN Table

## Introduction

All directly dialed services, such as Express Messaging, must have a corresponding entry in the SDN Table.

However, Call Answering services do not have an entry and are treated as a special case. These services do not have an entry because the number dialed (for example, a user's telephone number) is not in the SDN Table.

Since the dialed number is not found, the CDN used to route the call to CallPilot is used to determine the appropriate type of call answering service to start.

## CDNs used

The CDNs are the prime switch CDNs, even for call answering calls from satellite locations. Typically, two CDNs are used. One CDN is for call answering with the Multimedia Messaging service configured against it, with the media type set to Voice. The second CDN is for voice and fax call answering with the Multimedia Messaging service configured against it, with the media type set to Fax.

A result of this configuration is that even if fax call answering is used only on satellites, a corresponding CDN queue and SDN entry for Multimedia (fax media) must be configured.

# Adding and configuring SDNs in the SDN Table

## Introduction

NMS requires inbound and outbound SDNs for the services available on each satellite switch location as well as the services available on the prime switch location. Outbound SDNs are created automatically by the system.

## Inbound SDNs

An inbound SDN is not created automatically. You must add and configure each one.

## Before you begin

The SDN number must correspond to a dummy ACD-DN or phantom DN on the switch. Therefore, make sure you know these numbers before beginning the configuration.

**Note:** The voice or fax call answering on a satellite switch location uses the CDN on the prime switch location and is therefore not added to the SDN Table.

## SDN format for prime switch location

When adding SDNs for services at the prime switch location, enter them in local format.

### Example

Create an SDN for Express Messaging at the prime switch location with a phantom DN of 8365.

## SDN format for satellite location

When adding an SDN for a service at a satellite location, the SDN must be in a network format that is dialable from the prime location (when prefixed with the access code) because this is the number the switch passes to CallPilot.

Therefore, the SDN must include the ESN location code or the CDP steering code for the satellite switch location.

### Example

- ESN location code for satellite = 444
- Phantom DN for express messaging on satellite = 3544
- SDN for express messaging = 4443544

**Getting there** Nortel SMI > Meridian Application Server > System Configuration  
> Service Administration > Service Directory Number

## To add and configure a new inbound SDN

- 1 From the SDN Table, select New from the File menu.

**Result:** The New Inbound Service Directory Number Properties dialog box appears.

The screenshot shows a dialog box titled "New Inbound Service Directory Number Properties - CallPilot on MAS...". It has three tabs: "General", "Session Profile", and "Callback Handling". The "General" tab is selected. The dialog contains the following fields and controls:

- Service DN:** An empty text input field.
- Application:** A section containing:
  - Application ID:** A text input field containing the value "10".
  - Application Name:** A dropdown menu currently showing "AMIS Networking".
- Multimedia Channels and Media:** A section containing:
  - Media Type:** A dropdown menu currently showing "Voice".
  - Minimum Channels:** A text input field containing "0".
  - Maximum Channels:** A text input field containing "0".
  - Use Default Maximum:** An unchecked checkbox.
- Comments:** A large text area with scrollbars, currently empty.
- Buttons:** "Save", "Cancel", and "Help" buttons are located at the bottom right of the dialog.

- 2 On the General tab, enter the SDN number in the Service DN box.
 

**Note:** This number must correspond to a CDN or phantom DN on the switch.
- 3 Select an application from the Application Name list.
 

**Result:** The corresponding application ID appears above the application name in the Application ID box.
- 4 Select the type of channel required by the service in the Media Type list.
- 5 If you want to reserve a minimum number of channels for the service, enter the number in the Minimum Channels box.
- 6 Do one of the following:
  - Select the Use Default Maximum box.
 

**Note:** This is the recommended option.

- Enter the maximum number of channels that a service can use at one time in the Maximum Channels box.

**Note:** The maximum number of channels cannot exceed the total number of channels available on the server. If you enter a number larger than the total number of channels, a warning box appears asking you to change the number.

- 7 Enter any comments in the Comments box.
- 8 Click Save to add the SDN to the SDN Table.
- 9 Repeat steps 1–8 for every phantom DN and dummy ACD-DN on every satellite switch location.

## chapter 5

---

# Configuring CallPilot for NMS

This chapter describes how to configure CallPilot during the NMS installation process.

The chapter introduces the concepts that are necessary to understand the configuration process and provides detailed configuration procedures.

### In this chapter

<a href="#">Configuring the Meridian Application Server</a>	129
<a href="#">Configuring the switch locations</a>	137
<a href="#">Additional administrative tasks</a>	157





# Configuring the Meridian Application Server

## In this section

<a href="#">Overview</a>	130
<a href="#">Configuring the local messaging server</a>	132

# Overview

## Introduction

The implementation of NMS requires additional configuration of CallPilot. This configuration determines how the switch locations of an NMS site exchange messages.

The configuration process consists of three main steps:

- configuring the Meridian Application Server
- configuring the prime switch location
- adding and configuring each satellite switch location in the messaging network

CallPilot automatically assigns the prime switch location to the Meridian Application Server. The prime switch location requires additional configuration.

Each satellite switch location must be manually added. Each requires configuration.

## Before you begin

Before you begin to configure CallPilot, your switch locations must be completely set up and properly configured. The SDN Table must contain all necessary entries.

Dialing plan information is an important part of the configuration process. All dialing plan information must be gathered and available before beginning.

Use your messaging network representation as a guide for entering required information.

### **ATTENTION!**

---

It is strongly recommended that you perform each step in the configuration process in the order presented.

## Recommended procedure

Configure the prime switch location before configuring the satellite switches.

The process of configuring the prime switch location is almost identical to the process of configuring a satellite switch location.

## Capacity

A Meridian Application Server with NMS can support one prime switch location and up to 59 satellite switch locations.

## Messaging Network Configuration tree view

The Messaging Network Configuration tree view contains a graphical representation of your NMS network. The tree view shows the local Meridian Application Server and all switch locations.

Use the tree view to gain access to the Properties dialog boxes where you configure the Meridian Application Server and the prime switch location, and add and configure the satellite switch locations.

### See also

For a detailed discussion of the Messaging Network Configuration tree view and the Properties dialog boxes, consult the *Networking Planning Guide*.

# Configuring the local messaging server

## Introduction

When CallPilot is initially installed on your system, a Meridian Application Server and local switch location are automatically added to the Messaging Network Configuration tree view.

The Meridian Application Server must be configured. Configuring the server consists of saving general information about the server, such as name and description, to the network database.

The local messaging server is configured on the Local Messaging Server Properties—General tab.

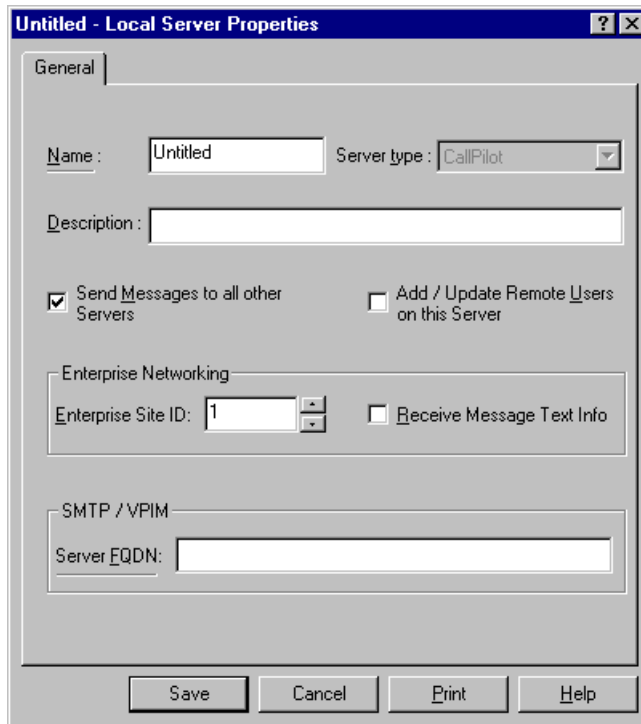

## **If another messaging solution is installed**

If Enterprise Networking, VPIM Networking, or both are installed on the local server, you must add placeholders to certain boxes on the Messaging Network Configuration—Local Server dialog box.

The dialog box cannot be saved if these boxes are left empty.

### **Enterprise Networking**

If Enterprise Networking is installed, you must provide a placeholder for the Enterprise site ID. You replace this placeholder with the actual site ID when implementing Enterprise Networking.

If you know the Enterprise site ID, enter it during configuration.

### **VPIM Networking**

If VPIM Networking is installed, you must provide a placeholder for the SMTP/VPIM Networking server FQDN. You replace this placeholder with the actual server FQDN when implementing VPIM Networking.

If you know the server FQDN, enter it during configuration.

## **Name**

The messaging server is usually given a name that corresponds to its geographic location. The name given to the messaging server becomes the name of the NMS network.

By default, both the Meridian Application Server and the prime switch location are assigned the name “Untitled.” You assign a new name to the server and prime switch location during configuration.

## **Server type**

The local server is always CallPilot.

## **Description**

A brief description of the Meridian Application Server or implementation notes, such as when the messaging server was configured or who completed the configuration, may be useful here.

## Remaining boxes

All other boxes on the General tab are configured only if a CallPilot networking solution is implemented. These boxes are completed during the implementation of that solution's messaging server.

### **Enterprise Networking and VPIM Networking**

Enter required placeholders if Enterprise Networking, VPIM Networking, or both, are installed on the messaging server. If Enterprise Networking is installed, you require an Enterprise Site ID. If VPIM Networking is installed, you require a Server FQDN.

If known, enter the required information.

**Getting there** Nortel SMI > Meridian Application Server > CallPilot > Networking > Messaging Network Configuration

## To configure the local messaging server

- 1 In the Messaging Network Configuration tree view, select the local messaging server.
- 2 On the File menu, click Open.

**Result:** The Local Prime Server Properties—General tab appears.

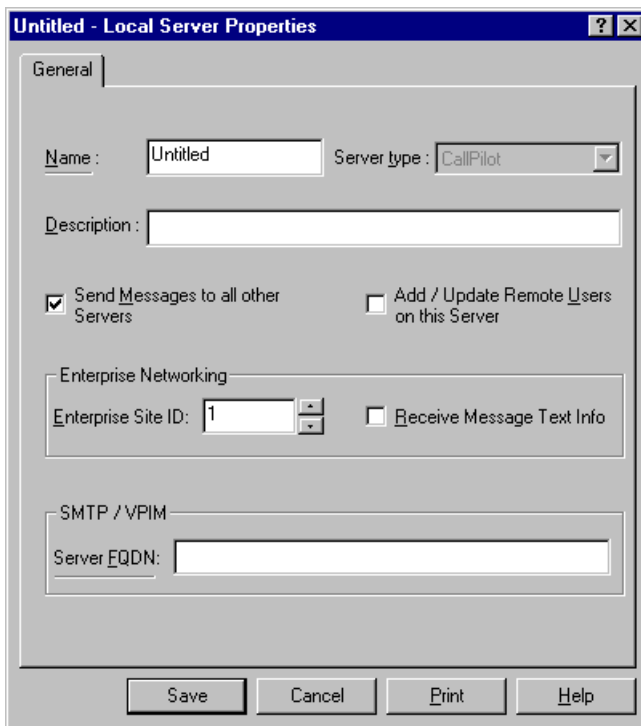

The screenshot shows a dialog box titled "Untitled - Local Server Properties" with a "General" tab selected. The dialog contains the following fields and options:

- Name:** A text box containing "Untitled".
- Server type:** A dropdown menu set to "CallPilot".
- Description:** An empty text box.
- Send Messages to all other Servers**
- Add / Update Remote Users on this Server**
- Enterprise Networking:**
  - Enterprise Site ID:** A dropdown menu set to "1".
  - Receive Message Text Info**
- SMTP / VPIM:**
  - Server EQDN:** An empty text box.

At the bottom of the dialog are four buttons: "Save", "Cancel", "Print", and "Help".

- 3 To change the name of the local messaging server, enter a new name in the Name box.

**Tip:** The name given to the messaging server is also the name of the NMS network.

**Note:** The server type is always CallPilot and cannot be changed.

- 4 In the Description box, enter details about the local messaging server.
- 5 Click Save.

**Result:** The information is validated and saved to the network database.

**What's next?**

After configuring the local messaging server, configure the local prime switch location.



# Configuring the switch locations

## In this section

<a href="#">About configuring the local prime switch location</a>	138
<a href="#">Configuring the ESN information</a>	144
<a href="#">Configuring the CDP information</a>	147
<a href="#">Adding and configuring a satellite switch location</a>	150
<a href="#">Recording a spoken name</a>	153
<a href="#">Importing a spoken name</a>	155

# About configuring the local prime switch location

## Introduction

When NMS is initially installed on the Meridian Application Server, a local messaging server and a local switch location are automatically added to the Messaging Network Configuration tree view.

Configure the local prime switch location to implement NMS.

## Prime Switch Location Properties dialog box

The local prime switch location is configured on the Prime Switch Location Properties dialog box, which has four tabs:

- General
- ESN
- CDP
- SMTP/VPIM

### General tab

Complete the General tab regardless of which dialing plan your site uses.

### ESN tab

Complete the ESN tab if the local site uses the ESN or a hybrid dialing plan.

### CDP tab

Complete the CDP tab if the local site uses the CDP or a hybrid dialing plan.

### SMTP/VPIM tab

The SMTP/VPIM tab is enabled only if VPIM Networking is installed on your local switch location. The SMTP/VPIM tab is completed during the implementation of VPIM Networking.

The screenshot shows a dialog box titled "Untitled - Prime Location Properties" with a standard Windows-style title bar (minimize, maximize, close buttons). The dialog has four tabs: "General", "ESN", "CDP", and "SMTP / VPIM". The "General" tab is selected and active. The "General" tab contains the following fields and controls:

- Name:** A text input field containing "Untitled".
- Description:** An empty text input field.
- Enterprise Location ID:** A numeric input field containing "0".
- Spoken Name Recorded:** A dropdown menu set to "No", with "Record..." and "Import..." buttons to its right.
- Dialing and addressing:** A section containing:
  - Dialing plans for dialing to this location:** Two checkboxes, "ESN" (checked) and "CDP" (unchecked).
  - Mailbox addressing follows dialing plan:** A checked checkbox.
  - Mailbox prefixes:** Two empty text input fields.

At the bottom of the dialog are four buttons: "Save", "Cancel", "Print", and "Help".

## Name

Each switch location must be assigned a name that is unique in the NMS network.

Usually, the name assigned to the prime switch location corresponds to the name of the messaging server. This ensures that the identity of the switch location within the network is immediately apparent. A geographic name is common.

For example, if a messaging server is named “Moscow,” the prime switch location is usually also named “Moscow.”

By default, the local prime switch location is given the name “Untitled.” This name must be changed.

## Description

This box is useful for short notes, reminders, or comments about the switch location.

You may find it useful to specify your switch model, the date of the switch configuration, or contact information for the switch technician.

## Enterprise Location ID

The Enterprise location ID of the prime switch location is set to 0 by default and cannot be changed.

## Spoken Name Recorded

The Spoken Name Recorded check box is enabled if NMS is installed.

When a user on a satellite switch location composes and sends a message to a user on the prime switch location, or uses the Play feature to hear who sent a message, the user hears the spoken name. This can be useful as a confirmation, especially when several switch locations use the same mailbox number.

If a spoken name is not recorded, local users hear the full address, such as “Mailbox 64441234.” If a recording is available, local users hear the switch location name followed by the mailbox number.

You can either record a message using the telephone or import a prerecorded WAV file.

If you do not want your local users to hear the name of this switch location when composing messages or using playback, do not record a message. For example, if you are using the CDP dialing plan and users dial in the same way as they send messages, you may feel that a spoken name is unnecessary.

## Dialing plans for dialing to this location

When configuring the local prime switch location, you are specifying the dialing plan that is used to dial to the local site.

You must specify the dialing plan used to dial to the local switch location:

- ESN
- CDP
- hybrid, combining ESN and CDP

If ESN is used anywhere in the messaging network, ESN must be selected, because an ESN access code is required.

## Mailbox addressing follows dialing plan

This box is dynamically enabled and disabled depending on the dialing plan specified.

A mailbox is often the same as the number used to dial a user, but this is not a requirement. For example, Joan Chen's mailbox number is 7575, but her extension number is 8888.

You must specify if, at your local site, the mailbox number is the name as the number dialed.

In most cases, the mailbox follows the dialing plan, and a mailbox prefix is not required.

However, if the mailbox does not follow the dialing plan, you must specify at least one mailbox prefix. The mailbox prefix identifies the location of the mailbox.

### **ATTENTION!**

---

It is strongly recommended that the mailbox follow the dialing plan. If the mailbox does not follow the dialing plan, some features, such as Call Sender, will not work.

## Mailbox prefixes

This box is dynamically enabled and disabled depending on the dialing plan specified.

A mailbox prefix is a leading string of digits that uniquely identifies a mailbox number as belonging to a particular site. A mailbox prefix is required only if the mailbox does not follow the dialing plan, that is, if users address a message differently than they dial.

The mailbox prefix is similar to an ESN location code or a CDP steering code. However, the mailbox prefix does not reflect a dialing plan. Instead, the prefix identifies a switch location in an NMS network.

If the local site has NMS installed, the mailbox prefix or prefixes must be configured.

**Note:** Two mailbox prefixes provide flexibility of addressing.

If a spoken name is not recorded, users hear the mailbox prefix combined with the mailbox number.

### Example

A switch location, Toronto, has the following mailbox prefixes:

- 83
- 1214597

Users can address to Toronto mailbox 1234 by entering 83 1234 or 1214597 1234.

Mailbox prefixes cannot conflict with other prefixes, such as the VPIM compose prefix and the AMIS compose prefix. Avoiding conflict may mean inserting leading digits—for example, 81214597.

**Getting there** Nortel SMI > Meridian Application Server > CallPilot > Networking > Messaging Network Configuration

## To configure the Prime Switch Location Properties dialog box

- 1 In the Messaging Network Configuration tree view, select the local prime switch location.
- 2 On the File menu, click Open.  
**Result:** The Messaging Network Configuration—Prime Switch Location Properties—General tab appears.
- 3 To change the name of the local prime switch location, enter a name in the Name box.
- 4 In the Description box, enter details about the local prime switch location.  
**Note:** The location ID is always 0 and cannot be changed.
- 5 To include recorded a spoken name, either
  - Click Record to record a message, or
  - Click Import to import a prerecorded message.  
**Note:** For detailed instructions on how to record a spoken name, consult [Sharing the configuration information](#) on page 158. For detailed instructions on how to import a prerecorded spoken name, consult [Importing a spoken name](#) on page 155.
- 6 Specify the dialing plan used to dial the local prime switch location. Select the
  - ESN check box if ESN is used
  - CDP check box if CDP is used
  - ESN and CDP check boxes if a hybrid dialing plan is used
- 7 If users address messages in the same way that they dial, select the Mailbox addressing follows dialing plan box.
- 8 If users do not address messages in the same way that they dial, enter at least one mailbox prefix.
- 9 Select the tab you must complete next to continue the configuration.

# Configuring the ESN information

## Introduction

If the local prime switch location uses either an ESN dialing plan or a hybrid dialing plan, you must complete the ESN tab.

You must provide the ESN access codes and ESN location codes. These are combined to create the ESN prefix.

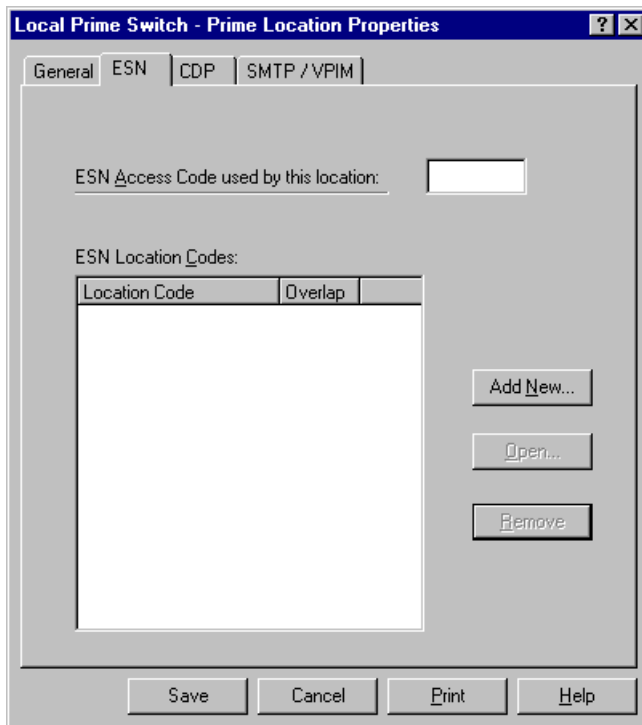

## See also

For a general description of the ESN dialing plan and how it works, consult the *Networking Planning Guide*.



## ESN Access Code used by this location

The ESN access code is used to access ESN routing in the same way that an access code, such as 9, is used to call out to the public network from a private network.

Typically, all switches in a messaging network use the same ESN access code.

## ESN Location Codes

An ESN location code is a routing prefix that identifies a location within a network. It is usually three digits long, but can be up to ten digits long.

You must also indicate the number of digits in the ESN location code that overlap with the mailbox number.

The ESN Location Codes list contains all ESN location codes currently assigned to the NMS network. The list also indicates the overlap between the ESN location code and the mailbox directory numbers.

ESN location codes can be added, modified, or deleted at any time. However, if overlaps are defined, then deletion may affect the remote user entries defined.

### ESN location code capacity

The maximum number of ESN location codes for a switch location is 30.

### ESN location code overlap

The ESN location code overlap is the number of digits shared by the location code and an extension number.

If there is overlap between the rightmost digit or digits of the location code and the leftmost digit or digits of the extension number, enter the amount of overlap.

The following table gives two examples of ESN location code overlap:

Access code	Location code	Extension number	Number dialed by users at other sites	Overlap
6	338	83000	633883000	0
6	338	83000	63383000	1

**Getting there** Nortel SMI > Meridian Application Server > CallPilot > Networking > Messaging Network Configuration

**To configure the ESN information**

- 1 Open the Prime Switch Location Properties—ESN tab.
- 2 Enter the ESN access code.
- 3 To add a new location code, click the Add New button.

**Result:** The New ESN Location Code Properties dialog box appears.

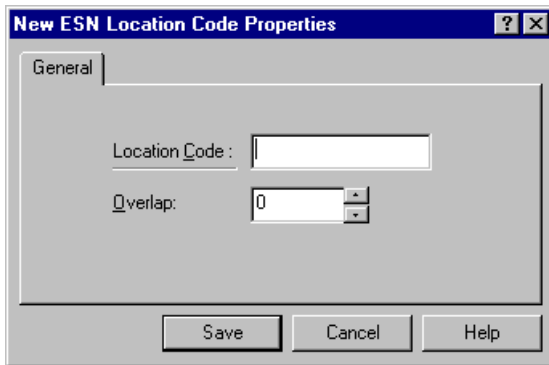

- 4 In the Location Code box, enter the location code.
- 5 In the Overlap box, enter the number of digits in the extension number that overlap the location code.
- 6 Click Save.

**Result:** The location code and overlap are validated and appear in the ESN Location Codes list box on the ESN tab.

- 7 Repeat steps 3–6 for each ESN location code required.
- 8 When you have finished configuring the ESN information, determine if you must configure CDP information.
  - If yes, click the CDP tab.
  - If no, click Save to validate the ESN configuration and save it to the database.

# Configuring the CDP information

## Introduction

If the local switch location uses either a CDP dialing plan or a hybrid dialing plan, complete the CDP tab.

You must provide the CDP steering codes.

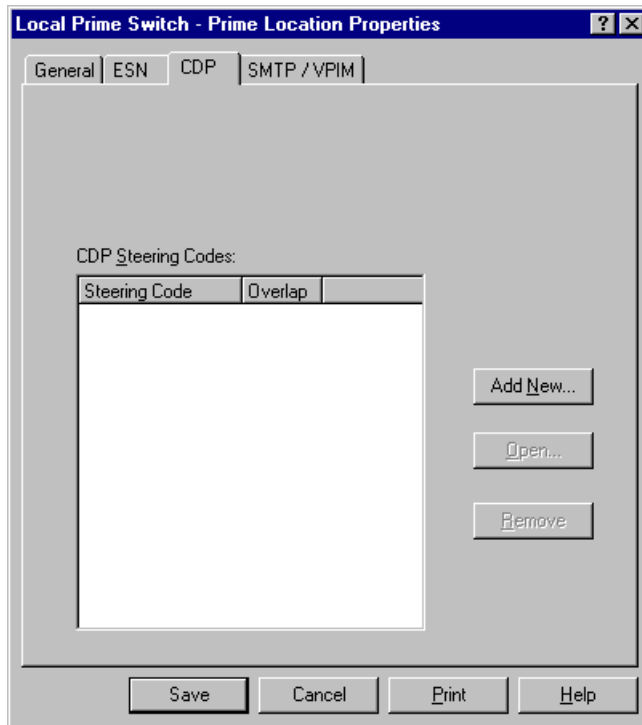

## See also

For a general description of the CDP dialing plan and how it works, consult the *Networking Planning Guide*.

## CDP Steering Codes

A CDP steering code is a site prefix that identifies the site and location within the network. Therefore, a CDP prefix must be unique for all switches in the messaging network.

The CDP steering codes must still be defined here, because the system must be able to identify the steering code in the mailbox number to determine the site and location.

The CDP Steering Codes list box contains all CDP steering codes currently assigned to the switch location. The list also indicates the overlap between the CDP steering code and the mailbox directory numbers.

CDP steering codes can be added, modified, or deleted.

### CDP steering code capacity

The maximum number of CDP steering codes for a switch location is 500.

### CDP steering code overlap

The CDP steering code overlap is the number of digits shared by the steering code and an extension number.

If there is overlap between the last digit or digits of the steering code and the first digit or digits of the extension number, enter the amount of overlap.

The steering code often overlaps with the first few digits of a local extension number. A full overlap, in which every digit of the steering code overlaps the extension, is typical.

The following table gives three examples of CDP steering code overlap:

Steering code	Extension number	Number dialed by users at other sites	Overlap
22	22345	2222345	0
22	22345	222345	1
22	22345	22345	2

**Getting there** Nortel SMI > Meridian Application Server > CallPilot > Networking > Messaging Network Configuration

## To configure the CDP information

- 1 Open the Prime Switch Location Properties—CDP tab.
- 2 Click the Add New button.

**Result:** The New CDP Steering Code Properties dialog box appears.

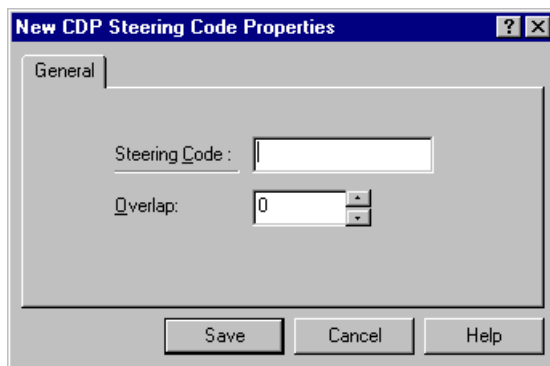

- 3 In the Steering Code box, enter the steering code.
- 4 In the Overlap box, enter the number of digits in the extension number that overlap the steering code.
- 5 Click Save.

**Result:** The steering code and overlap are validated and appear in the CDP Steering Codes list box on the CDP tab.

- 6 Repeat steps 2–5 for each CDP steering code required.
- 7 When you have added all necessary CDP steering codes, click Save.

**Result:** The information is validated and saved to the network database.

## What's next?

You have completed the configuration of the prime switch location and are ready to begin adding and configuring satellite switch locations.

# Adding and configuring a satellite switch location

## Introduction

You must add and configure each satellite switch location in the NMS network.

The process of configuring a satellite switch location is almost identical to the process of configuring the prime switch location.

## Satellite Switch Location Properties dialog box

A satellite switch location is configured on the Satellite Switch Location Properties dialog box. This dialog box consists of four tabs:

- General
- ESN
- CDP
- SMTP/VPIM

### General tab

You must complete the General tab regardless of which dialing plan your site uses.

### ESN tab

Complete the ESN tab if the local site uses the ESN or a hybrid dialing plan.

### CDP tab

Complete the CDP tab if the local site uses the CDP or a hybrid dialing plan.

### SMTP/VPIM tab

The SMTP/VPIM tab is enabled only if VPIM Networking is installed on your local switch location. The SMTP/VPIM tab is completed during the implementation of VPIM Networking.

**Remote Site Satellite Switch - Satellite Location Properties** [?] [X]

General | ESN | CDP | SMTP / VPIM

Name: Remote Site Satellite Switch

Description:

Enterprise Location ID: 1

Spoken Name Recorded: No [Record...] [Import...]

Dialing and addressing

Dialing plans for dialing to this location:

ESN  CDP

Mailbox addressing follows dialing plan

Mailbox prefixes: [ ] [ ]

Dialing prefix: [ ]

[Save] [Cancel] [Print] [Help]

**Getting there** Nortel SMI > Meridian Application Server > CallPilot > Networking > Messaging Network Configuration

## To configure a satellite switch location

- 1 In the Messaging Network Configuration tree view, select the local messaging server.
- 2 On the File menu, select New > Switch location.  
**Result:** The Satellite Switch Location Properties dialog box appears.
- 3 In the Satellite Switch Location Properties dialog box, complete the General tab.  
**Note:** For instructions on how to record a spoken name, consult [Sharing the configuration information](#) on page 158. For instructions on how to import a spoken name, consult [Importing a spoken name](#) on page 155.
- 4 Complete the ESN tab and the CDP tab as required.
- 5 Click Save.  
**Result:** The information is validated, and the satellite switch location is added to the remote site.
- 6 Repeat steps 1–5 for each satellite switch location required.
- 7 When all satellite switch locations are added, on the Messaging Network Configuration tree view, click Save to add the configured satellite switch locations to the network database.

## What's next?

If your NMS network is an NMS site within a larger messaging network, you must share the configuration details with all other network administrators.



# Recording a spoken name

## Introduction

You can create a recording of the name of a switch location. A recorded name is heard by a local user whenever an address is played back. A recorded name for a site is played if a user does not have a personal recorded name.

### Local switch location

If your local site is not an NMS site, a spoken name is not required for the local site.

If your local site is an NMS site, you can decide if you want to record a spoken name. For example, if the NMS site uses CDP, you may decide a spoken name is not necessary.

### Remote switch location

A spoken name should be available for every remote site in your Message Delivery Configuration tree view.

The recording is played when local users compose messages to the remote site.

## Importing a spoken name

If you do not want to record your own voice using the telephone, you can import a prerecorded WAV file. See [Importing a spoken name](#) on page 155.

## Before you begin

You need a telephone as a microphone.

## Getting there

Nortel SMI > Meridian Application Server > CallPilot > Networking > Messaging Network Configuration

### To record a spoken name

- 1 In the Messaging Network Configuration tree view, select the switch location of the site for which you want to record a spoken name.
- 2 On the File menu, select Open.  
**Result:** The Switch Location Properties dialog box appears.
- 3 On the General tab, click Record.  
**Result:** The Specify Phoneset dialog box appears.



- 4 Enter the telephone number of the telephone to be used as a microphone, and click Dial.  
**Result:** The telephone rings and the Voice Recorder dialog box appears.
- 5 Answer the telephone.
- 6 In the Voice Recorder dialog box, click Record.
- 7 Speak the name of the site into the telephone.
- 8 Click Stop.
- 9 To review the recording, click Play.
- 10 If you are satisfied with the recording, click Done.

# Importing a spoken name

## Introduction

You can import a prerecorded file of the name of a switch location. The recording is heard by a local user whenever an address is played back. A recording for a site is played if a user does not have a personal spoken name.

### Local switch location

If your local site is not an NMS site, a spoken name is not required for the local site.

If your local site is an NMS site, you can decide if you want to import a spoken name. For example, if the NMS site uses CDP, you may decide a spoken name is not necessary.

### Remote switch location

A spoken name should be available for every remote site in your Message Delivery Configuration tree view.

The recording is played when local users compose messages to the remote site.

## Instead of importing a spoken name

If you do not want to import a prerecorded spoken name, you can record your own voice message using the telephone.

## Before you begin

A prerecorded WAV file must be available. Check the quality of the recording before importing the file.

**Getting there** Nortel SMI > Meridian Application Server > CallPilot > Networking > Messaging Network Configuration

**To import a prerecorded file**

- 1 In the Messaging Network Configuration tree view, select the switch location of the site for which you want to import a prerecorded file.

- 2 On the File menu, select Open.

**Result:** The Switch Location Properties dialog box appears.

- 3 On the General tab, click Import.

**Result:** The Open dialog box appears.

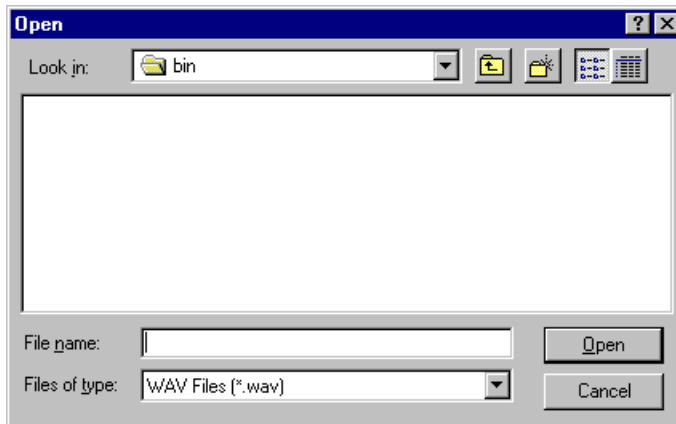

- 4 Select the WAV file, and click Open.

**Result:** The file is imported.

- 5 Close the Open dialog box.

# Additional administrative tasks

## In this section

<a href="#">Sharing the configuration information</a>	158
<a href="#">Adding local users</a>	159

# Sharing the configuration information

## Introduction

If your NMS network is an NMS site within a larger messaging network, you must share the details of your configuration with the network administrators of all sites with which your site exchanges messages.

These remote network administrators add your NMS site to their network databases.

## How to share configuration information

The easiest way to share the configuration information is to print the contents of Properties dialog boxes and to distribute the printouts to all network administrators.

**Getting there** Nortel SMI > Meridian Application Server > CallPilot > Networking > Messaging Network Configuration

## To print a Properties dialog box

- 1 From the Messaging Network Configuration tree view, open the Properties dialog box that you want to print.
- 2 Click Print.

**Result:** The contents of the selected Properties dialog box are printed. The printout includes the contents of all tabs.

# Adding local users

## Introduction

All users in an NMS network must be added to the Meridian Application Server as local users.

## Users on the prime switch location

Users on the prime switch location are added as local users.

## Users on the satellite switch locations

Users on the satellite switch locations are also added as local users. However, during the configuration of these users, the location must be specified from a drop-down list on the New User Properties dialog box—Mailbox tab.

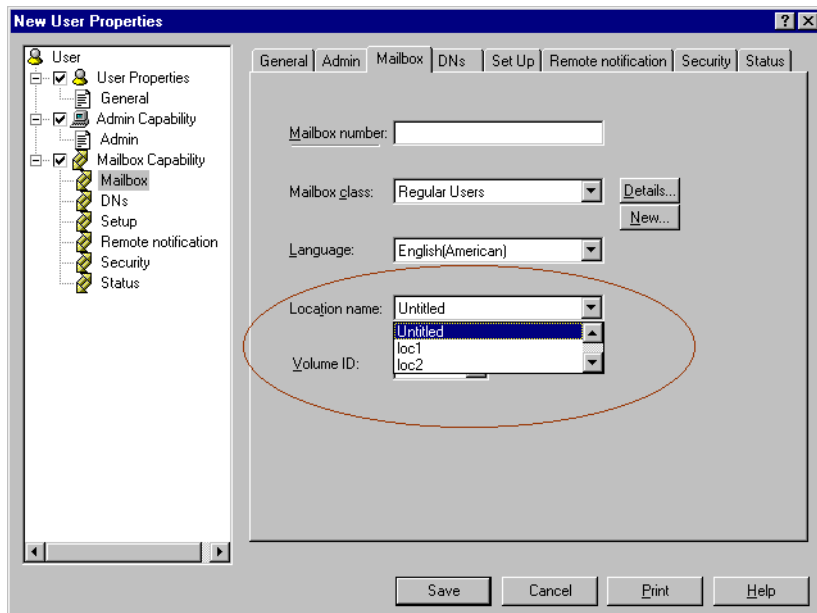

**Getting there** Nortel SMI > Meridian Application Server > User Administration > User Creation Templates

### To add a new satellite switch location user

- 1 In the New User Properties dialog box, select the type of template to be used.

**Result:** The template opens.

- 2 Complete all information that is required to create any user.
- 3 On the Mailbox tab, in the Location name drop-down list, select satellite.
- 4 Enter the name assigned to the satellite switch location in the Location name box.
- 5 When all required information is complete, click Save.

### See also

For detailed instructions on how to add local users, consult the relevant section in the *Basic Administration Guide*.



## chapter 6

---

# Testing and backing up NMS

This chapter describes how to test the configuration of your NMS network. The test suite ensures that NMS is working properly both locally and with remote sites.

This chapter also describes how to create a backup of your system to ensure that the configuration is not lost due to system failure.

### In this chapter

[Tests and backups](#)

163



# Tests and backups

## In this section

<a href="#">Overview</a>	164
<a href="#">Testing the NMS network</a>	165
<a href="#">Backups</a>	167

# Overview

## Introduction

After configuring CallPilot for NMS, test the system to ensure that it is working properly.

The NMS test suite determines if the NMS network is properly configured and if the switch locations can exchange messages.

Perform the tests in the sequence presented. If any test in the suite fails, resolve the problem before continuing with the tests.

## When to test the system

The NMS network should be tested

- after the initial setup and configuration of the NMS network
- after any subsequent changes are made to the configuration
- as part of the regular maintenance

## Before you begin

To run the tests, add some users to each switch location for the purpose of testing.

Enable the Auto-Login feature for some of the mailboxes so that this feature can be tested.

### See also

For instructions on how to add users, consult the relevant section in the *Basic Administration Guide*.

For instructions on how to enable the Auto-Login feature, consult the *Basic Administration Guide*.

# Testing the NMS network

## Introduction

After CallPilot is configured for NMS, the system must be tested.

The tests must be performed to ensure that the configuration is correct. If a test is not successful, resolve the problem and retry the test before continuing.

## DN test

The DN test determines that DNs are properly configured.

### To perform the DN test

From a telephone on any switch in the network:

Dial each of the Voice Messaging DNs on every switch in the network. Use the full ESN or CDP number of the Voice Messaging service.

The test is successful if you reach the Voice Messaging service for each switch.

## Auto-login test

The auto-login test determines if the Auto-Login feature, if enabled, is available to users on all switch locations in the NMS network.

### To perform the auto-login test

From a telephone that has the Auto-Login feature enabled:

- 1 Attempt auto-login by dialing the Voice Messaging service for the switch.
- 2 Repeat the test from a telephone with Auto-Login enabled on each switch.

The test is successful if you are logged in automatically and are not prompted for a mailbox number and password.

## Thru-dial test

The thru-dial test determines if users are able to use the Thru-Dial feature among switches in the NMS network.

### To perform the thru-dial test

From a telephone on a switch:

- 1 Log on to CallPilot.
- 2 Try to thru-dial an extension on another switch in the NMS network.
- 3 Repeat this test from a telephone on every switch in the network.

The test is successful if you are able to thru-dial to that extension.

## Features test

The features test determines if CallPilot features, such as Message Waiting Indicator (MWI) and Call Sender, are available throughout the NMS network.

### To perform the features test

From a telephone on a switch:

- 1 Compose and send a message to several mailboxes at each switch.
- 2 Confirm that the MWI lights are activated on all receiving telephones.
- 3 Call in to each mailbox, access each message, and use the Call Sender feature.
- 4 Repeat from a telephone on every switch in the NMS network. Address by all ESN, CDP, and local extension combinations.

The test is successful if you are able to send messages and the received messages offer full features.

## What's next?

After successfully completing the NMS test suite, perform a backup of your system.

# Backups

## Introduction

When all tests of the system are successfully completed and NMS is working properly, perform a backup.

The backup ensures that the configuration is not lost in the event of a system failure.

## Backup schedule

Perform backups as part of the implementation process and as part of regular maintenance activities.

### Implementation backup

Perform a manual backup as the final step in the NMS implementation process. This backup is needed even if the system is configured to perform an automatic backup.

In the unlikely event that the system experiences a disk failure before the automatic backup takes place, the network configuration could be lost.

### Maintenance backup

Perform a backup whenever the NMS configuration information is modified.

## System backup components

A system backup consists of two parts:

- a switch backup
- a CallPilot backup

### Switch backup

For detailed instructions on how to perform a switch backup, consult your switch documentation.

### CallPilot backup

You can perform a full or partial backup of your CallPilot server.

For detailed instructions on performing a CallPilot backup, consult the relevant section in the *Basic Administration Guide*.



# chapter 7

---

## Maintaining NMS

After you complete the NMS implementation process, you only need to perform regular maintenance.

This chapter describes maintenance procedures that must be performed regularly. The chapter also describes maintenance procedures that you perform only when required.

### In this chapter

<a href="#">About maintaining NMS</a>	171
<a href="#">Regularly scheduled maintenance tasks</a>	177
<a href="#">As-required maintenance tasks</a>	181



# About maintaining NMS

## In this section

<a href="#">Overview</a>	172
<a href="#">Network history</a>	174
<a href="#">Printing configuration information</a>	175

# Overview

## Introduction

After you successfully implement and test NMS, the system only requires maintenance.

There are two types of maintenance tasks:

- regularly scheduled tasks
- as-required tasks

## Regularly scheduled tasks

Regularly scheduled tasks include

- checking the network status
- reviewing Operational Measurement (OM) reports

Although you can perform regularly scheduled tasks at any time, perform these tasks at least once a week. Because these tasks do not interfere with the operation of NMS, you can schedule them at a convenient time during a regular workday.

If you monitor the performance of your messaging network, you avoid future problems. Careful monitoring shows bottlenecks in the system and indicates how the system can be improved.

Monitoring can also help you to plan and forecast future messaging network requirements.

## As-required tasks

Perform as-required tasks as needs arise. As-required tasks include

- modifying networking parameters
- disabling and enabling NMS
- modifications to the NMS configuration

**When to perform as-required tasks**

Since as-required tasks may affect the entire system, perform these tasks when the system is not in heavy use.

Modifications to the configuration may be necessary for the following reasons:

- New legal delivery times are announced for computer-generated calls.
- The system performance suggests that adjustments to the parameters are required.
- The system access number is changed.

**ATTENTION!**

---

Because as-required tasks may affect the performance of the entire system, schedule them for off-peak hours.

**Note:** There is no way to temporarily disable an NMS network.

**Perform a backup following maintenance**

Perform a backup of the system whenever you modify the network parameters as part of your maintenance.

# Network history

## Introduction

Keep detailed records of your network's history. These records can

- Indicate significant performance or equipment issues that real-time monitoring may not detect.
- Provide a background for comparing the current information.
- Contain information needed during support calls.

## Information to record

A network history should include the following types of information:

- installation dates and descriptions
- contact information for all key personnel involved in the system installation and configuration
- details of software installed on the messaging server, including versions
- installation process and results, including tests
- diagrams of the initial and subsequent network configurations
- any problems encountered and their solutions
- hardware and software changes
- changes to the messaging network layout

## Where to keep the records

Make the records of your messaging network easy to access and read. Graphics, including hand-drawn sketches, can be very useful.

Keep records in a log or online. Note, however, that online records cannot be accessed if the system crashes.

## See also

For a detailed description of messaging network histories, consult the *Networking Planning Guide*.

# Printing configuration information

## Introduction

Printouts of the system configuration are often included in a network history. You can print all configuration information contained in your local network database.

To print configuration information, you must open the relevant Properties dialog box. For example, to print an item in the Messaging Network Configuration tree view, you must open the Properties dialog box of the item.

If a Properties dialog box consists of more than one tab, the contents of all tabs are printed.

**Note:** You cannot print the tree view of the messaging network contained in the Messaging Network Configuration dialog box.

## When to print configuration information

Although configuration information is always available in the most recent backup of your network database, you may find it convenient to make printouts as well.

Printouts of the configuration information are especially useful in the following situations:

- You must fax information to a remote network administrator.
- You are keeping a network history.
- You are planning to change a configuration or delete an item from the Messaging Network Configuration tree view, and you want a hard copy of the original configuration.

**Getting there** Nortel SMI > Meridian Application Server > CallPilot > Networking > Message Delivery Configuration or Messaging Network Configuration

### **To print configuration information**

- 1 Open the dialog box that you want to print.
- 2 With the dialog box open, click the Print button.

**Result:** The contents of the dialog box print. The printout includes the contents of all tabs.



# Regularly scheduled maintenance tasks

## In this section

[Reviewing OM reports and alerts](#)

178

# Reviewing OM reports and alerts

## Introduction

Operational Measurement (OM) reports and alerts provide detailed information on the status and performance of NMS.

No reports specifically provide NMS information because, to CallPilot, users on the satellite switches are local users.

However, the reports that provide information specific to each switch location are useful for determining the system's performance.

## Primary reports

The following reports provide useful information:

- System Traffic
- Channel Usage
- Disk Usage Monitor
- MMFS Usage Monitor
- Service Quality Detail
- Service Quality Summary

## Additional reports

Statistics for each switch location are also provided in reports that are associated with individual users or where users can be used as a filtering or grouping criteria, even though the switch location is not displayed.

These reports are

- 800 Access Bill-back
- Messaging Usage Bill-back
- Network User Bill-back
- RN Usage Bill-back
- DTT Usage Bill-back
- Call Answering/User Responsiveness (filter only)

- Mailbox Counts (group only)
- Messaging Usage (filter only)
- Users Exceeding Storage Limit
- Top Users of Storage

Although you can review OM reports at any time, you should review them at least weekly.

### **Access to OM reports is restricted**

The generation of OM reports is a restricted activity that is determined by access level. If you do not have the necessary access, you must ask your system administrator to generate the reports.

The OM report request screens let you choose the reports that you want to view and print. For many reports, you can also customize the displayed results so that you receive the information in a format that best suits your needs.

### **See also**

For additional information on OM reports, including how to generate and interpret them, consult the *Reporter Guide*.



# As-required maintenance tasks

## In this section

<a href="#">Modify the local messaging server</a>	182
<a href="#">Modify the prime switch location</a>	183
<a href="#">Adding, modifying, and deleting satellite switch locations</a>	185

# Modify the local messaging server

## Introduction

It is unlikely that you will have to modify the configuration of the local messaging server. However, if necessary, it can be modified.

## NMS network

The configuration of the local messaging server to implement an NMS network is simple. This configuration requires the name assigned to the messaging server and a description. These can be changed easily and will not affect any other aspect of the system.

## NMS site

If the local NMS network is part of a larger messaging network—that is, it is an NMS site—modifications to the local messaging server are more complicated.

For detailed instructions on modifying the local messaging server, consult the appropriate implementation and administration guides.

# Modify the prime switch location

## Introduction

You can modify the configuration of the prime switch location.



---

### **Risk of loss of functionality**

Changes to the networking configuration should be done during hours when users are not logged on. Making changes to the configuration while users are logged on may result in loss of messaging functionality.

## **NMS network modifications**

You can change the configuration of your prime switch location.

Common modifications include changes to the spoken name recorded, to ESN prefixes, and to CDP steering codes.

Uncommon modifications, such as changes to the dialing plan, should be made only when absolutely necessary.

To make any modifications to the prime switch location, use the process described for the original implementation.

## **NMS site modifications**

If your NMS network is a site within a larger network, any additions, modifications, or deletions that you make affect the entire network.

To ensure the continued integrity of the network, follow these steps:

1. Make all required changes.
2. Perform the NMS networking suite of tests to ensure that the changes are acceptable.
3. Perform all necessary networking solution test suites.
4. Perform a backup of your system.
5. Inform the system administrators of all other sites on the network of the changes that you have made.
6. Ask the system administrators to change their Messaging Network Configuration entries to reflect your changes.



# Adding, modifying, and deleting satellite switch locations

## Introduction

If your NMS network is a site within a larger network, any modifications that you make affect the entire network.



---

### Risk of loss of functionality

Changes to the networking configuration should be done during hours when users are not logged on. Making changes to the configuration while users are logged on may result in loss of messaging functionality.

**Getting there** Nortel SMI > Meridian Application Server > CallPilot > Networking > Messaging Network Configuration

## Adding a satellite switch location

To add a new satellite switch location to the NMS network, follow the instructions described in “Adding and configuring a satellite switch location” on page 150.

**Note:** If the NMS network is a site in a larger network, deleting a satellite switch location at your location will affect the configuration of all other sites in the network with which you exchange messages. You must contact the administrators of all other sites and ask them to add the satellite switch location from their Messaging Network Configuration tree views also.

## To modify a satellite switch location configuration

- 1 In the Messaging Network Configuration tree view, highlight the satellite switch that you want to modify.

- 2 On the File menu, select Properties.

**Result:** The Satellite Switch Location Properties dialog box for the selected switch appears.

- 3 Make all required changes to the tabs, and click Save.

- 4 Test and back up the system.

**Note:** If your NMS network is a site in a larger network, any modifications that you make to your switch setting will affect the entire network. Inform remote network administrators of all changes.

## Deleting a satellite switch location

When a satellite switch location is no longer required in an NMS network, it must be removed from the Messaging Network Configuration tree view.

## To delete a satellite switch location

- 1 In the Messaging Network Configuration tree view, highlight the satellite switch that you want to delete.

- 2 On the File menu, select Delete.

- 3 Press Save.

**Result:** The deleted satellite location no longer appears in the Messaging Network Configuration tree view.

## chapter 8

---

# Troubleshooting NMS

Although testing and regular maintenance ensure that your NMS site is working properly, the system may experience occasional problems.

This chapter describes how to diagnose and correct these problems.

### In this chapter

<a href="#">Overview</a>	189
<a href="#">Problem: User unable to log in to mailbox</a>	191



# Overview

## Introduction

If you are experiencing problems with NMS, this chapter will help you to identify and solve these problems.

Common causes of NMS problems include the following:

- Networking information is incorrect or incomplete.
- The switch is configured incorrectly.

## Identifying the source of the problem

To identify the source of the NMS problem, first determine if NMS is disabled.

**Note:** You cannot temporarily disable NMS on the Meridian Application Server. NMS is disabled on the switch. To determine if NMS is disabled, check the restrictions on the switch.

If NMS is not disabled, then review the following:

- appropriate Alarm and Event reports
- network status
- Operational Measurement (OM) reports

## Switch-related problems

If you are unable to identify the problem using CallPilot, the problem may be switch-related. Perform the call trace test to determine if there is a problem with the switch configuration.

### Call trace

Call trace helps you to determine if network calls are being blocked for one or more of the following reasons:

- Digit manipulation is performed incorrectly. Either not enough or too many digits are inserted or deleted.
- Class of service restrictions are either too stringent or too loose.
- Dialing is incorrect. More digits are required by the trunks or trunk routes.

**Note:** You can perform a call trace on a telephone or on a trunk and a trunk route.

## Hardware problems

If you are unable to locate the problem in the CallPilot configuration or in the switch, your system may be experiencing hardware problems that are not related to networking.

Perform a basic hardware check. Examine all connections.

# Problem: User unable to log in to mailbox

## Introduction

When a user on a satellite switch phones the voice only messaging DN on the satellite switch, the user should be able to enter the mailbox with only a mailbox number and a password. No prefix should be necessary.

If a user is unable to log in properly, you must determine the cause of the problem.

## Diagnostic

There are two likely causes for the problem:

- The switch is incorrectly configured.
  - The DNs are incorrect.
- CallPilot is incorrectly configured.
  - The SDN Table is incorrect or incomplete.

**Note:** If the system worked before but is not currently working, check if the user login is disabled.

## Solution

If you determine that the problem is not switch-related, check the configuration of the SDN Table.

There must be entries in the SDN Table for all services provided by the satellite switch location.

If a CDP dialing plan is used, ensure that the SDN is in a format that is dialable from the prime switch location.

If an ESN dialing plan is used, ensure that the SDN is in a format that is dialable from the prime, but do not include the ESN access code.

## **Other necessary actions**

After making changes to the SDN table, complete the NMS test suite. If the problem is corrected, perform a partial backup of the system.

## **Contact technical support**

If you are unable to correct the problem and must contact technical support, have the following information available:

- network history
- error messages
- network representation with dialing plan information



# Field index

## C

- CDP Steering Code
  - overlap, 148
  - Prime and Satellite Switch Location Properties dialog boxes, 148

## D

- Description
  - Local Messaging Server Properties dialog box, 133
  - Prime and Satellite Switch Location Properties dialog boxes, 140
- Dialing plans for dialing to this location
  - Prime and Satellite Switch Location Properties dialog boxes, 141

## E

- Enterprise Location ID
  - Prime and Satellite Switch Location Properties dialog boxes, 140
- Enterprise Site ID, 134
- ESN Access Code
  - Prime and Satellite Switch Location Properties dialog boxes, 145
- ESN Location Code
  - overlap, 145
  - Prime and Satellite Switch Location Properties dialog boxes, 145

## L

- Local Messaging Server Properties dialog box
  - Add/Update Remote Users on this Server, 134
  - Description, 133
  - Enterprise Site ID, 134
  - Name, 133

- Receive Message Text Info, 134
- Send Messages to all other Servers, 134
- Server FQDN, 134
- Server type, 133

## M

- Mailbox addressing follows dialing plan
  - Prime and Satellite Switch Location Properties dialog boxes, 141
- Mailbox prefixes
  - Prime and Satellite Switch Location Properties dialog boxes, 142

## N

- Name
  - Local Messaging Server Properties dialog box, 133
  - Prime and Satellite Switch Location Properties dialog boxes, 140

## P

- Prime and Satellite Switch Location Properties dialog boxes
  - CDP Steering Code, 148
  - Description, 140
  - Dialing plans for dialing to this location, 141
  - Enterprise Location ID, 140
  - ESN Access Code, 145
  - ESN Location Code, 145
  - Mailbox addressing follows dialing plan, 141
  - Mailbox prefixes, 142
  - Name, 140
  - Spoken Name Recorded, 140

**S**

Server FQDN, 134

Server type

- Local Messaging Server Properties dialog box, 133

Spoken Name Recorded

- Prime and Satellite Switch Location Properties dialog boxes, 140

# Index

## A

- access mechanism, 65
  - direct access, 65
  - indirect access, 66
  - offnet access, 66
- ACD-DNs, on existing satellite switches, 118
- adding a satellite switch location to an existing NMS network, 185
- adding an NMS site to a messaging network, 89
- adding users
  - local, 159
  - on prime switch location, 159
  - on satellite switch location, 159
- AML. *See* Application Module Link
- another dialing plan, not supported, 69
- Application Module Link
  - connection between Meridian Application Server and prime switch, 63
  - previously known as, 63
  - use of DFDN in event of failure, 63
- Attendant Extended Call feature, interaction with NMS, 73

## B

- Barge-in Attendant feature, interaction with NMS, 73
- benefits of messaging network representation, 95
- benefits of NMS, 61
- broadcast message, 69

## C

- Call Answering services
  - CDN configuration, 122
  - not listed in SDN Table, 122
- Call Forward by Call Type Allowed feature, interaction with NMS, 72
- Call Forward feature

- interaction with NMS, 71
- types supported, 71
- call trace, using to troubleshoot, 190
- CallPilot
  - configuring for NMS, 130
  - features supported by NMS, 67
- CDNs
  - for services not in SDN Table, 122
  - relationship with phantom DNs and ACD-DNs illustrated, 107
- CDP dialing plan
  - and user location, 77
  - ESN dialing plan recommended, 85
  - how to configure information, 149
  - maximum number of CDP steering codes, 148
  - restrictions, 82
- CDP steering code, 148
  - overlap with extension number, 148
- CDP tab
  - Prime Switch Location Properties dialog box, 139
  - Satellite Switch Location Properties dialog box, 151
- CO Loop Start trunk, 73
- combining several switch locations into one user location, 79
- Command and Status Link, now known as Application Module Link, 63
- concepts required to configure switches for NMS, 104
- Conference Call feature, interaction with NMS, 73
- configuration
  - Meridian Application Server
    - overview, 87, 132
    - modifying of local messaging server, 182
    - modifying of prime switch location, 183
    - overview, 87
    - prime switch location overview, 87
    - switch locations overview, 104
  - configuration information

- how to print, 176
- printing, 175
- configuring CallPilot for NMS
  - overview, 130
  - preliminary requirements, 130
  - recommended procedure, 131
- configuring prime switch location, 138
- configuring satellite switch locations, overview, 87, 113
- coordinating switch administrators to configure switches for NMS, 105
- CSL (Command and Status Link), 63

## D

- defining dummy ACD-DNs, 113
- definition
  - Network Class of Service, 101
  - prime switch location, 60
  - private messaging network, 59
  - satellite switch location, 60
  - service directory number (SDN), 119
  - tandem switch location, 60
  - user location, 60
- deleting a satellite switch location, 186
- desktop user logon, 64
- dialing plan
  - and user location, 77
  - another dialing plan, 69
  - CDP dialing plan restrictions, 82
  - hybrid dialing plan requirements, 82
  - importance of understanding, 76
  - recommended dialing plan, 85
  - types supported by NMS, 76
  - types used by NMS, 69
  - uniform plan requirement, 80
- dialing restriction, NMS, 80
- direct inward system access, required for offnet access, 66
- DISA (direct inward system access), 66
- disabling NMS, 189
- dummy ACD-DNs
  - defining, 113
  - how to define on satellite switch, 114
  - number required, 106

- on satellite switch locations, 106
- relationship with phantom DN's and CDNs
  - illustrated, 107
- setting to night call forward, 114

## E

- end-to-end signaling (EES), limitations, 69
- ESN dialing plan
  - and user location, 77
  - how to configure information, 146
  - recommended over CDP dialing plan, 85
- ESN location code
  - maximum number, 145
  - overlap, 145
  - overlap with extension number, 145
  - used by this location, 145
- ESN tab
  - Prime Switch Location Properties dialog box, 139
  - Satellite Switch Location Properties dialog box, 151

## F

- feature interaction with NMS, 71
- features supported by NMS, 67
- format required for SDNs at prime switch location, 123
- format required for SDNs at satellite switch locations, 124
- forwarding phantom DN's, 115

## G

- gathering required information
  - new implementation, 85
  - upgrade, 85
- General tab
  - Local Messaging Server Properties dialog box, 132
  - Prime Switch Location Properties dialog box, 139

Satellite Switch Location Properties dialog box, 151

## H

hardware problems, 190  
 how phantom DN, dummy ACD-DNs, and CDNs work together, 107  
 how to  
   add a satellite switch location user, 160  
   add and configure a new inbound service directory number (SDN), 125  
   configure a satellite switch location, 152  
   configure CDP dialing plan information, 149  
   configure ESN dialing plan information, 146  
   configure prime switch location, 143  
   configure telephone for user on satellite switch, 117  
   configure the local messaging server, 135  
   define a dummy ACD-DN, 114  
   delete a satellite switch location, 186  
   forward a phantom DN, 116  
   import a spoken name, 156  
   modify satellite switch location configuration, 186  
   print a Properties dialog box, 158  
   print configuration information, 176  
   record a spoken name, 154  
 hybrid dialing plan, requirements, 82

## I

implementation  
   configuring satellite switches, 86  
   gathering required information, 85  
   main steps in process, 84  
   preliminary requirements, 84  
 implementation main steps  
   configure satellite switches, 86  
   configuring the NMS network, 87  
   gather information, 85  
   test and back up system, 88  
 implementation overview, 84  
 importing a spoken name, 155, 156  
 inbound SDNs, 123

  satellite switch locations, 119  
 inbound service directory number (SDN)  
   how to add and configure new, 125  
 information required for implementation, 85  
 information required to configure satellite switch locations, 113  
 Integrated Service Digital Network (ISDN), 63  
 Integrated Services Digital Network/  
   Applications Protocol link, now known as Application Module Link, 63  
 interaction with NMS, 73  
 ISDN, signaling limitations, 68  
 ISDN/AP (Integrated Services Digital Network/  
   Applications Protocol link), 63  
 ISDN-PRI, between switches, 63

## L

local messaging server  
   how to configure, 135  
   modifying configuration, 182  
 Local Messaging Server Properties dialog box,  
   General tab, 132  
 location name, required by desktop users to log on, 64  
 log on, desktop users and location name, 64

## M

maintenance  
   as-required tasks, 172  
   performing backup after, 173  
   regularly scheduled maintenance tasks, 172  
   types of maintenance, 172  
   when to perform, 173  
 MAS. *See* Meridian Application Server  
 Meridian 1 (Release 23C), prime switch, 68  
 Meridian Application Server  
   configuration overview, 87, 132  
   connection to prime switch with Application Module Link, 63  
   how to configure, 135  
   modifying configuration, 182  
   SDN Table on, 109, 119  
 message

- broadcast, 69
  - transmission times, 70
- message center directory number, 69
- Message Delivery Configuration tree view,
  - capacity, 68
- message transmission times, 70
- messaging network
  - adding an NMS site, 89
  - sharing configuration information with
    - remote administrators, 158
- Messaging Network Configuration dialog box,
  - contents of tree view, 131
- messaging network representation
  - benefits, 95
  - overview, 95
  - sample diagram, 96
- modifying configuration
  - local messaging server, 182
  - of NMS network, 183
  - of NMS site, 184
  - prime switch location, 183
- modifying satellite switch location
  - configuration, 185

## N

- NCOS. *See* Network Class of Service
- NCRD. *See* Network Call Redirection
- Network Call Redirection, 66
  - network call forward all calls, 66
  - network call forward busy, 66
  - network call forward no answer, 66
  - network hunting, 66
  - types supported, 66
- Network Call Transfer feature, interaction with
  - NMS, 72
- Network Class of Service
  - checking current setting, 101
  - definition, 101
  - level required by NMS, 101
- network history, 174
- Network Hunting feature, interaction with
  - NMS, 72
- Network Message Service. *See* NMS
- night call forward dummy ACD-DNs, 114

- NMS (Network Message Service), 58, 59
  - access mechanisms, 65
  - and phantom DNs, 86
  - and users, 64
  - Attendant Extended Call feature, 73
  - Barge-in Attendant feature, 73
  - benefits, 61
  - Call Forward by Call Type Allowed feature,
    - 72
  - Call Forward feature, 71
  - CO Loop Start trunk, 73
  - Conference Call feature, 73
  - configuring CallPilot, 130
  - dialing plan types used, 69
  - dialing plans supported, 76
  - dialing restriction, 80
  - disabled on switch, 189
  - features, 67
  - implementation overview, 84
  - interaction with features, 71
  - keeping a network history, 174
  - key terms, 60
  - maintenance, 172
  - Network Call Transfer feature, 72
  - Network Class of Service level required, 101
  - Network Hunting feature, 72
  - NMS site, 59
  - Operational Measurement reports, 178
  - printing configuration information, 175
  - SDN Table requirements, 123
  - SDNs and, 119
  - signaling limitations, 68
  - troubleshooting, 189
- NMS network
  - as type of private messaging network, 59
  - modifications to configuration, 183
- NMS site
  - configuration overview, 89
  - modifications to configuration, 184
  - spoken name imported for, 155
  - spoken name recorded for, 153
- NSM network, 58
- number of dummy ACD-DNs required on
  - satellite switch locations, 106
- number of switch locations supported, 68

**O**

offnet access, 66  
 switch requirements, 66  
 OM reports. *See* Operational Measurement reports and alerts  
 Operational Measurement reports and alerts  
 access to reports, 179  
 reports to review, 178  
 reviewing, 178  
 outbound SDN, 123  
 overlap  
 calculating for CDP steering code and extension number, 148  
 ESN location code and extension number, 145  
 overlay  
 how to work with, 110  
 used to configure satellite switch locations, 110

**P**

performance information, how to find, 178  
 phantom DNs  
 and NMS, 86  
 determining those used on prime switch location, 111  
 forwarding, 115  
 how to forward, 116  
 instead of ACD-DNs on existing satellite switches, 118  
 on satellite switch locations, 107, 115  
 prime switch location, 111  
 relationship with dummy ACD-DNs and CDNs, 107  
 satellite switch locations, 109  
 preliminary requirements for implementation, 84  
 prime switch  
 configuration overview, 111  
 satellite switches forward to, 86  
 type supported, 68  
 prime switch location  
 adding users, 159

communicating with satellite switch locations using ISDN-PRI, 63  
 configuration, 87, 138  
 connection to Meridian Application Server with Application Module Link, 63  
 definition, 60  
 determining phantom DNs used on, 111  
 how to configure, 143  
 information required to configure, 111  
 modifying configuration, 183  
 phantom DNs, 111  
 using virtual signaling to communicate with satellite switches, 63  
 Prime Switch Location Properties dialog box  
 CDP tab, 139  
 completing CDP tab, 147  
 completing ESN tab, 144  
 completing General tab, 143  
 ESN tab, 139  
 General tab, 139  
 SMTP/VPIM tab, 139  
 tabs, 138  
 printing configuration information, 175, 176  
 private messaging network  
 definition, 59  
 typical, 60  
 problems with NMS, 189  
 call trace, 190  
 determining if NMS is disabled, 189  
 hardware, 190  
 identifying source, 189  
 switch-related problems, 190  
 user unable to log in to mailbox, 191

**R**

recommended procedure for configuring CallPilot, 131  
 record keeping, 174  
 recording a spoken name, 154  
 remote administrators, sharing configuration information with, 158  
 remote switch location, spoken name, 153, 155  
 reviewing Operational Measurement reports and alerts, 178

## S

- satellite switch
  - configuration required to implement, 86
  - forwarding to prime switch, 86
  - how to define a dummy ACD-DN, 114
  - types supported, 68
  - upgrade of existing, 118
- satellite switch location, 115
  - adding, 185
  - adding to existing NMS network, 185
  - adding users, 159
  - configuration, 87, 152
  - configuring telephones of users, 117
  - defining dummy ACD-DNs, 113
  - definition, 60
  - deleting, 185, 186
  - dummy ACD-DNs, 106
  - forwarding phantom DNs, 116
  - included in broadcast message, 69
  - information required to configure, 113
  - modifying configuration, 185, 186
  - number of ACD-DNs required, 106
  - overlays for configuration, 110
  - phantom DNs, 107, 109, 115
  - SDN, 121
  - setting dummy ACD-DNs to night call
    - forward, 114
- satellite switch location configuration overview, 113
- Satellite Switch Location Properties dialog box
  - CDP tab, 150
  - ESN tab, 150
  - General tab, 150
  - SMTP/VPIM tab, 150
  - tabs, 150
- satellite switch location SDNs, in SDN Table, 109
- service directory number (SDN)
  - adding and configuring new, 125
  - and NMS, 119
  - definition, 119
  - format for prime switch location, 123
  - format required for satellite switch locations, 124
  - inbound, 119
  - satellite switch locations, 121
- Service Directory Number (SDN) Table
  - configuration overview, 88
  - contents, 109, 120
  - overview, 119
  - preliminary requirements before adding
    - SDNs, 123
  - satellite switch location, 109
  - services not included, 122
- sharing configuration information, 158
- signaling limitations, 68
  - end-to-end signaling (EES), 69
  - ISDN, 68
  - virtual signaling, 69
- skills required to configure switches for NMS, 104
- SMTP/VPIM tab
  - Prime Switch Location Properties dialog box, 139
  - Satellite Switch Location Properties dialog box, 151
- spoken name
  - for remote switch location, 153, 155
  - importing, 155, 156
  - importing for local NMS site, 155
  - recording, 154
  - recording for local NMS site, 153
  - recording overview, 153
- steering code, maximum number, 148
- switch configuration
  - assumptions, 104
  - importance of checking preliminary configuration, 100
  - overview, 104
  - preliminary requirements, 105
  - skills required, 104
- switch location
  - corresponds to user location, 77
  - prime, 60
  - satellite, 60
  - several correspond to user location, 78
  - tandem, 60
- switch location configuration, cooperation
  - among administrators required, 105
- switch-related problems, 190
  - call trace, 190



## T

- tandem switch location, definition, 60
- telephone
  - configuring for users on satellite switch locations, 117
  - how to configure for user on satellite switch, 117
- terms used in this guide, 60
- transmission times of messages, 70
- tree view
  - contents, 131
  - Messaging Network Configuration dialog box, 131
- troubleshooting NMS, 189
  - call trace, 190
  - determining if NMS is disabled, 189
  - hardware problems, 190
  - identifying source of problem, 189
  - switch-related problems, 190
  - user unable to log in to mailbox, 191

## U

- uniform dialing plan, 80
  - beyond private messaging network, 81
  - within NMS network, 80
  - within private messaging network, 80
- uniform dialing plan required, 80
- upgrade, information required to, 85
- upgrading existing satellite switches
  - changing ACD-DNs to phantom DNs, 118
  - overview, 118
  - using existing ACD-DNs, 118
- user
  - adding local users, 159
  - and NMS, 64
  - configuring telephone when on satellite switch location, 117
  - unable to log in to mailbox, 191
- user location, 77
  - and CDP dialing plan, 77
  - and ESN dialing plan, 77
  - corresponds to several switch locations, 78
  - corresponds to switch location, 77

- definition, 60
- using switch overlays, 110

## V

- virtual signaling, 63
  - limitations, 69



CALLPILOT, NORTEL NETWORKS, NORTEL, NORTEL NETWORKS HOW THE WORLD SHARES IDEAS, NORTHERN TELECOM, BNR, DMS, DMS-100, DMS-250, DMS-MTX, DMS-SCP, DNC, DPN, DUALMODE, HELMSMAN, IVR, LINK, MAP, MERIDIAN DIGITAL CENTREX (MDC), MERIDIAN, MERIDIAN 1, MERIDIAN LINK, MERIDIAN MAIL, MERIDIAN MAX, MFA, NORSTAR, SL-1, SL-100, SUPERNODE, SYMPOSIUM, and UNITY are trademarks of Northern Telecom Limited. TELESIS is a trademark of Bell-Northern Research.

ACCENT is a trademark of Accent Software International Ltd.

ACTION REQUEST SYSTEM and AR SYSTEM are trademarks of Remedy Corporation.

AMDEK is a trademark of Amdek Corporation.

ANSI is a trademark of the American National Standards Institute, Inc.

AT&T is a trademark of American Telephone and Telegraph Corporation.

ATRIA is a trademark of Pure Atria Corporation.

CASEWARE is a trademark of Caseware, Inc.

CLEARCASE is a trademark of Rational Software Corporation.

CONTINUUS and CONTINUUS/CM are trademarks of Continuous Software Corporation.

CRYSTAL REPORTS is a trademark of Seagate Software Inc.

FRAME, FRAMEBUILDER, FRAMEMAKER, and POSTSCRIPT are trademarks of Adobe Systems Incorporated.

HELVETICA and TIMES are trademarks of Linotype Corporation.

HITACHI is a trademark of Hitachi Limited.

LOGITECH is a trademark of Logitech, Inc.

MACINTOSH and APPLE are trademarks of Apple Computer Inc.

MICROSOFT, MICROSOFT WINDOWS, MICROSOFT WINDOWS NT, MS-DOS, and POWERPOINT are trademarks of Microsoft Corporation.

NOVELL is a trademark of Novell, Inc.

PCANYWHERE is a trademark of Symantec.

PROMARK and RHOBOT are trademarks of DMI Promark, Inc.

SONY is a trademark of Sony Corporation.

SYBASE is a trademark of Sybase, Inc.

3COM is a trademark of 3Com Corporation.

UNIX is a trademark of Novell, Inc.

WINRUNNER is a trademark of Mercury Interactive Corporation.

# CallPilot

## NMS Implementation and Administration Guide

Toronto Information Products  
Nortel Networks  
522 University Avenue, 14th Floor  
Toronto, Ontario, Canada  
M5G 1W7

Copyright © 1998 Northern Telecom, All Rights Reserved.

Information is subject to change without notice. Northern Telecom reserves the right to make changes in design or components as progress in engineering and manufacturing may warrant.

The process of transmitting data and call messaging between the Meridian 1 and the Meridian Application Server is proprietary to Northern Telecom. Any other use of the data and the transmission process is a violation of the user license unless specifically authorized in writing by Northern Telecom prior to such use. Violations of the license by alternative usage of any portion of this process or the related hardware constitutes grounds for an immediate termination of the license and Northern Telecom reserves the right to seek all allowable remedies for such breach.

The information in these back matter pages contains Northern Telecom and third-party trademarks.

Publication number: 555-7101-302

Product release: 1.0

Document release: Standard 1.0

Date: November 1998

Printed in the United States of America



*How the world shares ideas.*