



Telset Administration Guide

BCM 4.0

Business Communications Manager

Document Status: **Standard**

Document Version: **03**

Part Code: **N0060610**

Date: **June 2006**

Copyright © Nortel Networks Limited 2006

All rights reserved.

The information in this document is subject to change without notice. The statements, configurations, technical data, and recommendations in this document are believed to be accurate and reliable, but are presented without express or implied warranty. Users must take full responsibility for their applications of any products specified in this document. The information in this document is proprietary to Nortel Networks.

Trademarks

*Nortel, Nortel (Logo), the Globemark, and This is the way, This is Nortel (Design mark) are trademarks of Nortel Networks.

*Microsoft, MS, MS-DOS, Windows, and Windows NT are registered trademarks of Microsoft Corporation.

All other trademarks and registered trademarks are the property of their respective owners.

Contents

Getting started with BCM	5
About this guide	5
Purpose	5
Audience	5
Acronyms	6
Symbols and conventions used in this guide	6
Related publications	8
How to get Help	8
Administration telset interfaces	11
Initial setup telset menus	11
Using FEATURE 9*8 for initial configuration	12
Logging in to the F9*8 interface	12
Entering keycodes and feature settings	14
Activating user accounts and changing passwords	15
Viewing or entering IP network information	15
System restart	17
Using the telset configuration interface	19
Programming with the telset telephony interface	19
User access to the FEATURE**CONFIG interface	20
Programming telephones	21
Navigating the telset menus	21
Top-level menu of the telset telephony configuration tree	25
About the FEATURE **CONFIG menu system	25
Terminals and Sets	26
Lines	31
Services	33
System speed dials	36
Passwords	37
Time and Date	38
System programming	39
Telco features	46
Hardware	47
Maintenance	49
Usage metrics	51
Index	53

Getting started with BCM

This section contains information on the following topics:

- [“About this guide” on page 5](#)
- [“Audience” on page 5](#)
- [“Acronyms” on page 6](#)
- [“Symbols and conventions used in this guide” on page 6](#)
- [“Related publications” on page 8](#)
- [“How to get Help” on page 8](#)

About this guide

The *BCM 4.0 Telset Administration Guide* describes how to use the Telset interface to administer your BCM system. The telset configuration is a tool that is used for system configuration if there is no network connection to your BCM. In this guide, BCM Release 4.0 refers to BCM 200, BCM 400, and BCM 1000 main units that are running the BCM Release 4.0 software.

Purpose

The tasks described in the guide relate to the initial setup of the BCM system, and the configuration of telephone sets.

In brief, the information in this guide explains:

- start-up programming
- keycodes and feature settings
- activating user accounts and changing passwords
- viewing and entering IP network information
- programming telephones

Audience

The *BCM 4.0 Telset Administration Guide* is directed to network administrators responsible for maintaining BCM networks. This guide is also useful for network operations center (NOC) personnel supporting a BCM managed services solution. To use this guide, you must:

- be an authorized BCM administrator within your organization
- know basic Nortel BCM terminology
- be knowledgeable about telephony and IP networking technology

Acronyms

The following is a list of acronyms used in this guide.

Table 1 List of acronyms

Acronym	Description
BCM	Business Communications Manager
BRI	Basic Rate Interface
DHCP	Dynamic Host Configuration Protocol
DN	Directory Number
IP	Internet Protocol
ISDN	Integrated Switched Digital Network
NOC	Network Operations Center
ONN	Outgoing Name and Number
PRI	Primary Rate Interface
SM	Silent Manager

Symbols and conventions used in this guide

These symbols are used to highlight critical information for the BCM system:



Caution: Alerts you to conditions where you can damage the equipment.



Danger: Alerts you to conditions where you can get an electrical shock.



Warning: Alerts you to conditions where you can cause the system to fail or work improperly.



Note: A Note alerts you to important information.



Tip: Alerts you to additional information that can help you perform a task.



Security note: Indicates a point of system security where a default should be changed, or where the administrator needs to make a decision about the level of security required for the system.



Warning: Alerts you to ground yourself with an antistatic grounding strap before performing the maintenance procedure.



Warning: Alerts you to remove the BCM main unit and expansion unit power cords from the ac outlet before performing any maintenance procedure.

These conventions and symbols are used to represent the Business Series Terminal display and dialpad.

Convention	Example	Used for
Word in a special font (shown in the top line of the display)	<code>Pswd:</code>	Command line prompts on display telephones.
Underlined word in capital letters (shown in the bottom line of a two line display telephone)	<u>PLAY</u>	Display option. Available on two line display telephones. Press the button directly below the option on the display to proceed.
Dialpad buttons	#	Buttons you press on the dialpad to select a particular option.

These text conventions are used in this guide to indicate the information described:

Convention	Description
bold Courier text	Indicates command names and options and text that you need to enter. Example: Use the info command. Example: Enter show ip {alerts routes} .
<i>italic text</i>	Indicates book titles
plain Courier text	Indicates command syntax and system output (for example, prompts and system messages). Example: Set Trap Monitor Filters
FEATURE HOLD RELEASE	Indicates that you press the button with the coordinating icon on whichever set you are using.

Related publications

Related publications are listed below. To locate specific information, you can refer to the *Master Index of BCM 4.0 Library*.

Keycode Installation Guide (N0060625)

CallPilot Telephone Administration Guide (N0060618)

BCM 4.0 Administration Guide (N0060598)

How to get Help

This section explains how to get help for Nortel products and services.

Getting Help from the Nortel Web site

The best way to get technical support for Nortel products is from the Nortel Technical Support Web site:

<http://www.nortel.com/support>

This site provides quick access to software, documentation, bulletins, and tools to address issues with Nortel products. More specifically, the site enables you to:

- download software, documentation, and product bulletins
- search the Technical Support Web site and the Nortel Knowledge Base for answers to technical issues
- sign up for automatic notification of new software and documentation for Nortel equipment
- open and manage technical support cases

Getting Help over the phone from a Nortel Solutions Center

If you don't find the information you require on the Nortel Technical Support Web site, and have a Nortel support contract, you can also get help over the phone from a Nortel Solutions Center.

In North America, call 1-800-4NORTEL (1-800-466-7835).

Outside North America, go to the following Web site to obtain the phone number for your region:

<http://www.nortel.com/callus>

Getting Help from a specialist by using an Express Routing Code

To access some Nortel Technical Solutions Centers, you can use an Express Routing Code (ERC) to quickly route your call to a specialist in your Nortel product or service. To locate the ERC for your product or service, go to:

<http://www.nortel.com/erc>

Getting Help through a Nortel distributor or reseller

If you purchased a service contract for your Nortel product from a distributor or authorized reseller, contact the technical support staff for that distributor or reseller.

Administration telset interfaces

You can use Element Manager or you can use the Telset interface to administer your BCM system. The telset configuration is a tool that is used for system configuration if there is no network connection to your BCM, or for quick configuration changes, such as changing features in a DN record or updating one of the speed dial lists. Administration telset interfaces are accessible only by a user with an Installer level of telset user privileges. These menus are used at initial startup or to make changes to security-sensitive system settings.

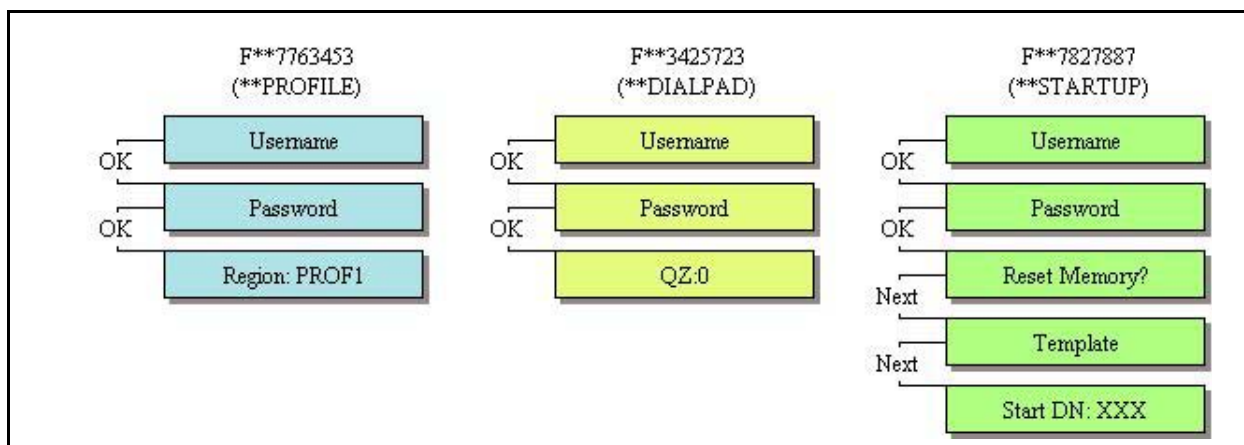
- [“Initial setup telset menus” on page 11](#)
- [“Using FEATURE 9*8 for initial configuration” on page 12](#)

Initial setup telset menus

The initial telset menus are used during the initial configuration of your system. The user requires Installer (Administrator) level of password to use these menus. The following three features must be done within 15 minutes of power up:

FEATURE **7763453	(**PROFILE)	should only be run at the initial set up if the Startup profile did not properly set the country profile on your system and the Element Manager is not accessible to perform this task.
FEATURE **3425723	(**DIALPAD)	allows you to change how the system receives Q and Z in the telset interface.
FEATURE **7827887	(**STARTUP)	should only be run at the initial set up if the Startup profile did not set the telephony profile to the correct setting and the Element Manager is not accessible to perform this task. Note that using this interface returns your system to the default state

Figure 1 Menus for profiles and dialpad function for startup programming



Using FEATURE 9*8 for initial configuration

FEATURE 9*8 provides access to menus that allow you to:

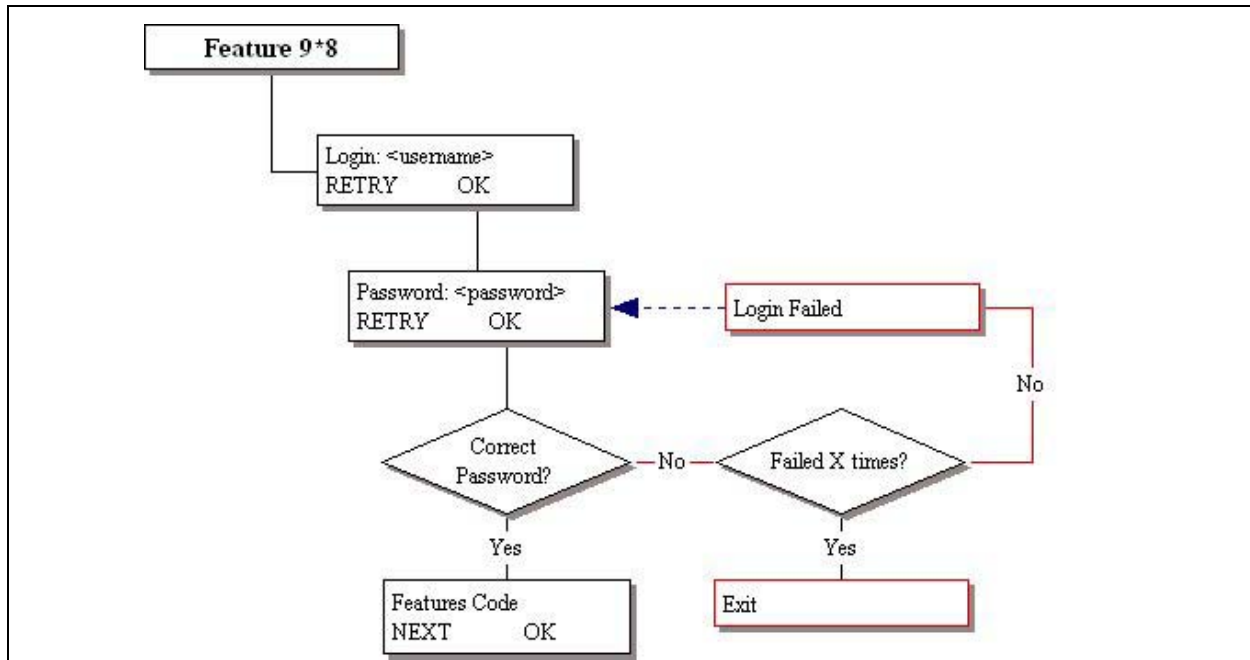
- add a keycode for applications such as mail boxes, Fax suite, and private networking. See [“Entering keycodes and feature settings” on page 14](#)
- change user accounts and passwords. See [“Activating user accounts and changing passwords” on page 15](#)
- view or set the IP network addressing. See [Viewing or entering IP network information on page 15](#)
- enable or disable the soft modem. See [“System restart” on page 17](#)
- restart your system. See [“System restart” on page 17](#)

Logging in to the F9*8 interface

An administration-level telset username and password are required to access this interface. Use the following user ID and password to access the FEATURE 9*8 feature:

User ID	SETNNA (738662)
Password	CONFIG (266344)

For more information about accessing the telset interfaces, and about which telephones can be used to access the interface, refer to [“Using the telset configuration interface” on page 19](#). Note that this interface does not use the keypad directional arrows that are used for the telephony interface, but rather follows the conventions of the CallPilot F983 interface, which uses display prompts to navigate through the menus.

Figure 2 Log in menu

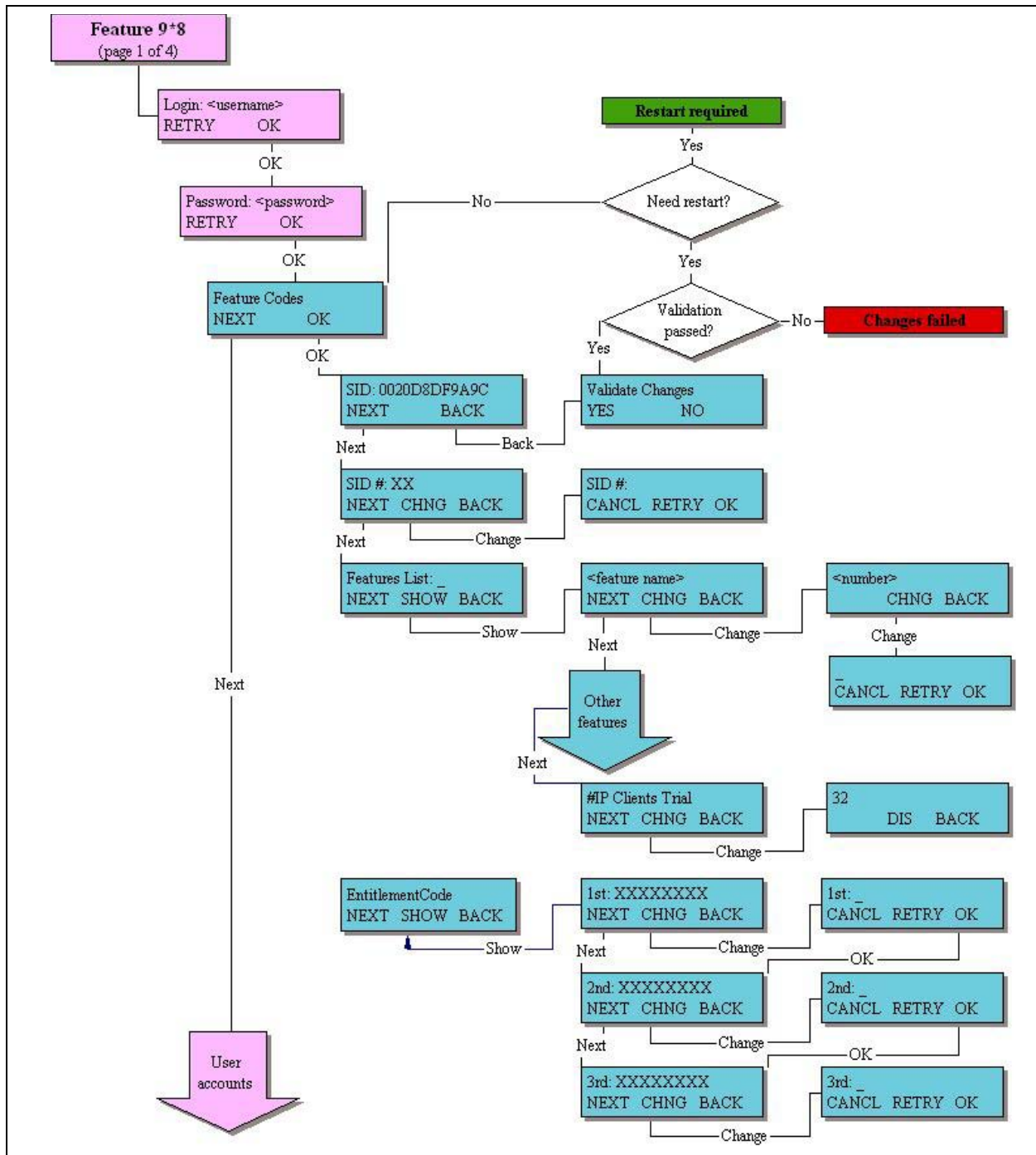
When a user enters an incorrect password, the system provides a display indicating that there is an entry error. If the user tries repeatedly to enter an invalid username or password, the system locks the user account. The user can wait until the lockout timer releases the account, or the account can be released through this telset menu by a user with administration privileges or through the Element Manager by a user with administration privileges. The lockout timer and the lockout release can be configured in the Element Manager.

Entering keycodes and feature settings

Features List provides a list of applications that have applied keycodes in the system. When you add applications or increase a feature capacity, you can make those adjustments through this menu. For details about keycodes, refer to *Keycode Installation Guide*.

Figure 3 shows the layout for Features List.

Figure 3 Accessing the Features List

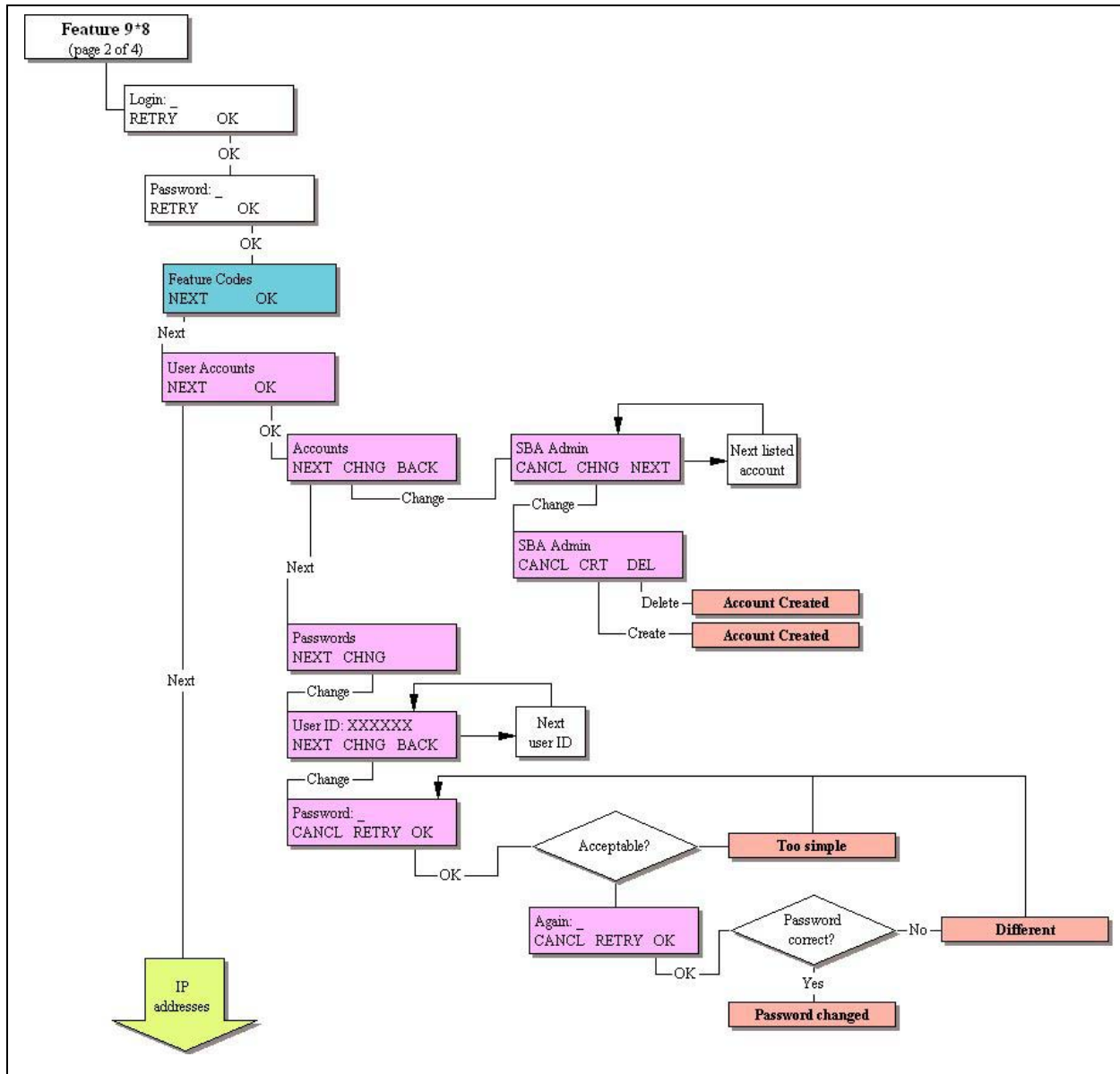


Activating user accounts and changing passwords

User Accounts provides two menus, one to create or delete user accounts and the other to enter new passwords for user accounts. The username and password can each be 16 digits in length.

Figure 4 shows the layout for User Accounts.

Figure 4 Accessing user accounts and passwords

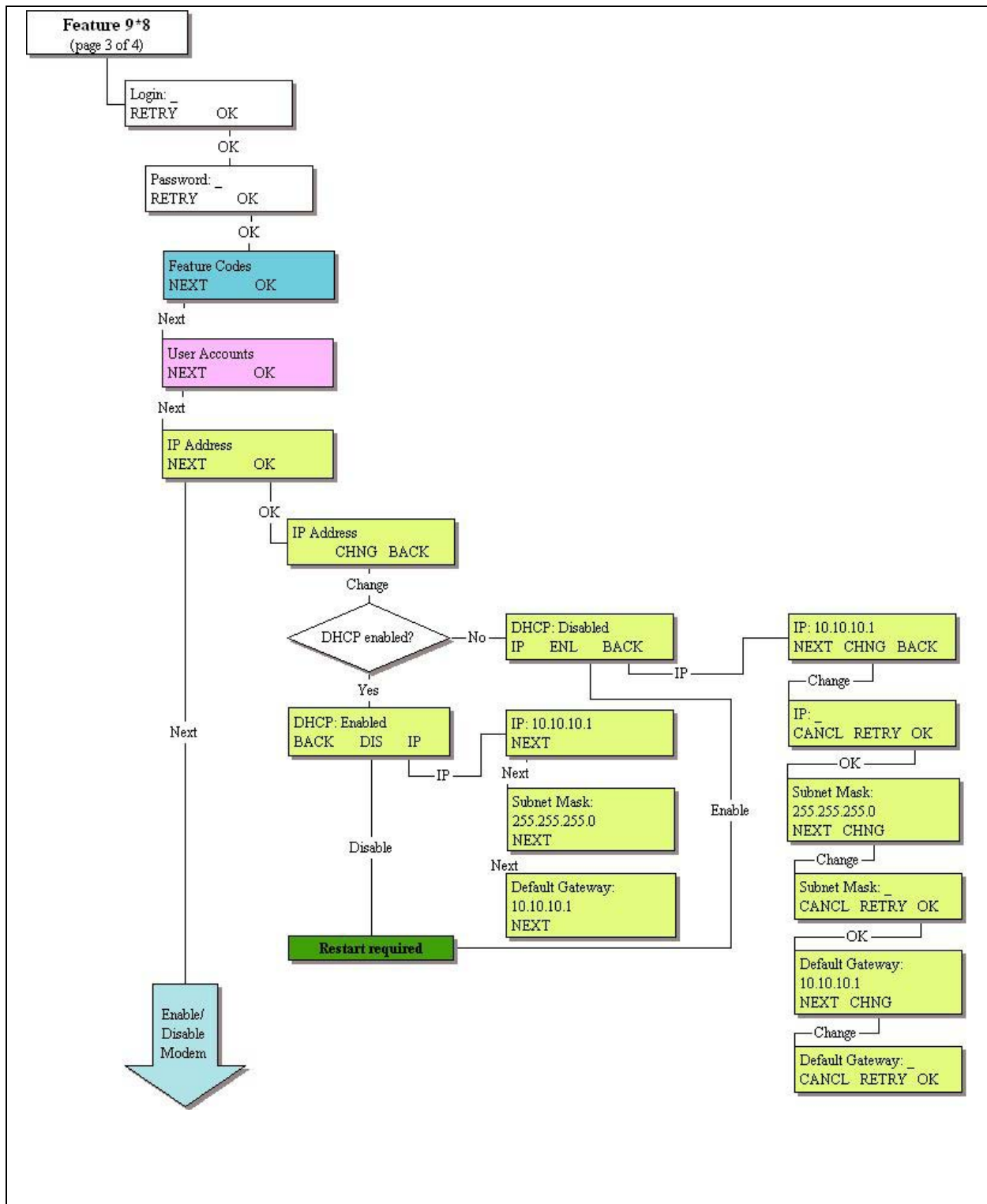


Viewing or entering IP network information

IP Address allows you to view IP network information on systems where DHCP is enabled. On systems where DHCP is disabled, you can enable DHCP or enter static IP network information.

Figure 5 shows the layout for IP Address.

Figure 5 Viewing or setting the IP network information



System restart

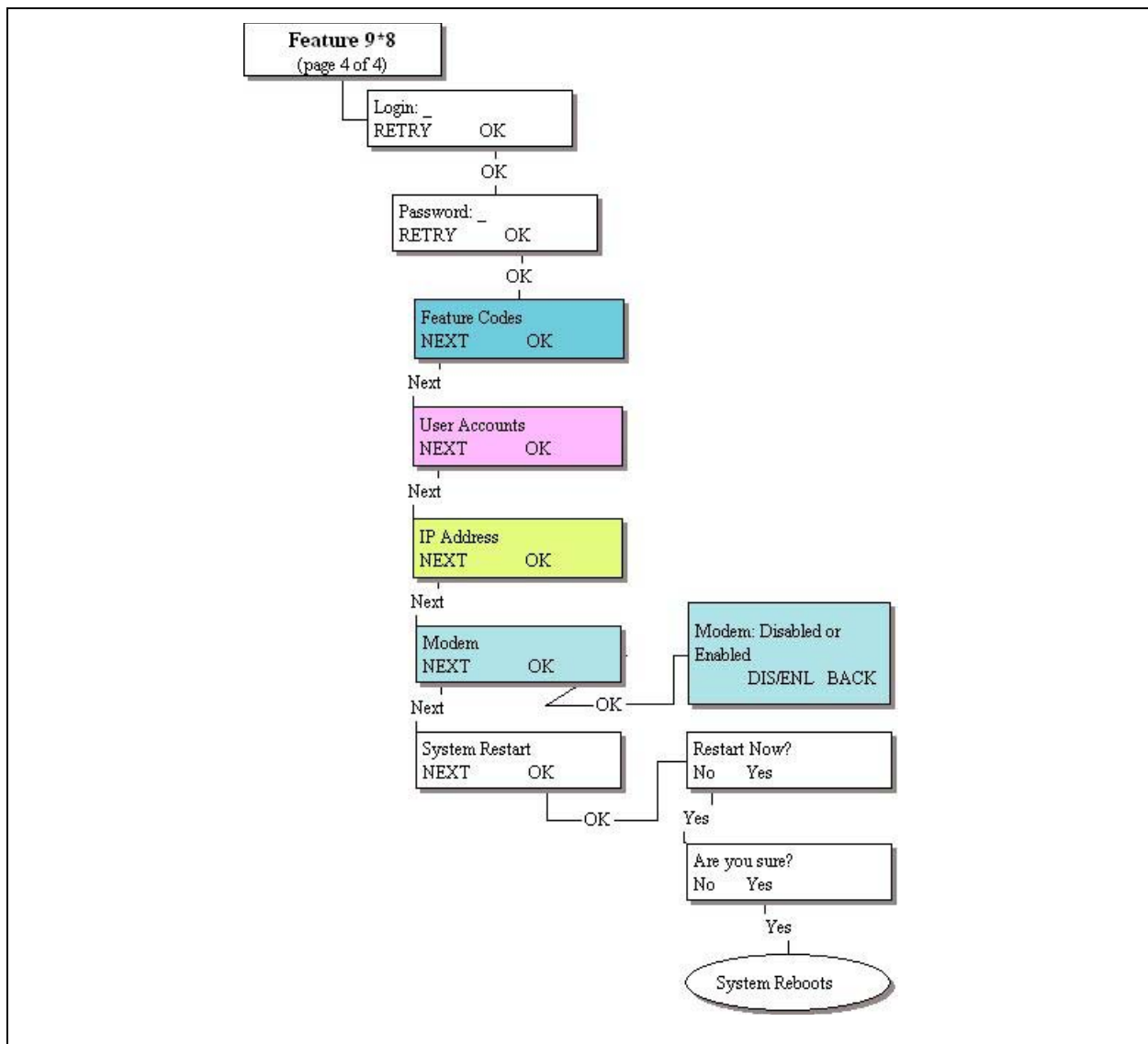
The System Restart heading allows you to reboot the BCM 4.0 main unit. Use this when changes you have made indicate that a reboot is required.



Warning: Restarting the system interrupts system service.

Figure 6 shows the layout for System Restart.

Figure 6 Restarting the system



Using the telset configuration interface

This section provides maps of the telset configuration menus. The telset configuration is a tool that is used for system configuration if there is no network connection to your BCM, or for quick configuration changes, such as changing features in a DN record or updating one of the speed dial lists.

Although these menus have most of the features found in the Element Manager user interface, they are not necessarily in the same location. The goal of this section is to help you quickly locate feature programming within the telset configuration menus.



Note: For telset administration for CallPilot Vmail via F983, see the *Call Pilot Telephone Administration Guide*.

Programming with the telset telephony interface

When your system is installed, your installer, or customer service representative, programs it to work with your telephone lines, with your private network if you have one, and with optional equipment. In some cases, they also can provide customization for your specific office requirements. If your system is connected to an IP network, the Element Manager interface provides the most complete access for system programming and any post-installation adjustments you may want to make.

However, if your system is not connected to an IP network, or if your system administrators do not have access to a computer with the Element Manager installed, you can use the telset configuration interface to program or customize your system settings.

Some settings will need to be updated regularly, because of staff requirements or new business contacts, and it is sometimes easier to make quick changes through this menu rather than through the Element Manager.

There are four ways to use the telset configuration interface to customize and maintain your BCM system:

- Initial programming is performed for you by your installer or customer service representative. This establishes how the system interacts with lines, telephones, and other equipment. The user who performs the initial programming also has access to the FEATURE 9*8 telset configuration menu, which allows access to system administration features.
- Post-installation programming, for example to change how features work for the system, is performed by a user assigned as a system coordinator.
- Post-installation programming for basic configuration changes can be provided to the telset user without exposing the more sensitive programming areas. For example:
 - set user information (FEATURE **user (FEATURE **8737))
 - set the Q and Z on the dialpad (FEATURE **dialpad (FEATURE **3425723))

- Personal programming, to change functions related to how the telephone works, is available to anyone through the Feature button on the telephone.

User access to the FEATURE**CONFIG interface

User identification and user passwords are required to access the telset configuration menus (FEATURE **CONFIG). Although there are a set of default user IDs and passwords, for security purposes it is recommended strongly that these be changed as part of the initial startup activities. Also, it is recommended that each user has a unique user ID and password. This allows for more accurate usage tracking.

User identification and passwords for the telset interface are defined either in the Element Manager or by using the FEATURE 9*8 telset administration menu, see [“Using FEATURE 9*8 for initial configuration” on page 12](#), which is only accessible to users with administrator (Installer) privileges.

There are four levels of user access for the telset telephony configuration menus. These are described in the [Table 1](#). Refer to the system administration information for the Element Manager for information about assigning these access privilege levels to users. Refer to [“Activating user accounts and changing passwords” on page 15](#) through that interface.

A user with Installer or System coordinator+ privileges can also use the Password heading in this menu to change passwords for each privilege level.

Table 1 User access privileges

Access privilege levels	Description of access
Installer	Has full access to all telset menus, including FEATURE 9*8.
System coordinator+	Has full access to all telset telephony menus relating to telephony system or device set up.
System coordinator	Has more limited access to telset telephony menus relating to telephony system and device set up. For example, this level of user cannot define trunks.
Basic	Has access limited to changing DN record information.
Debug	

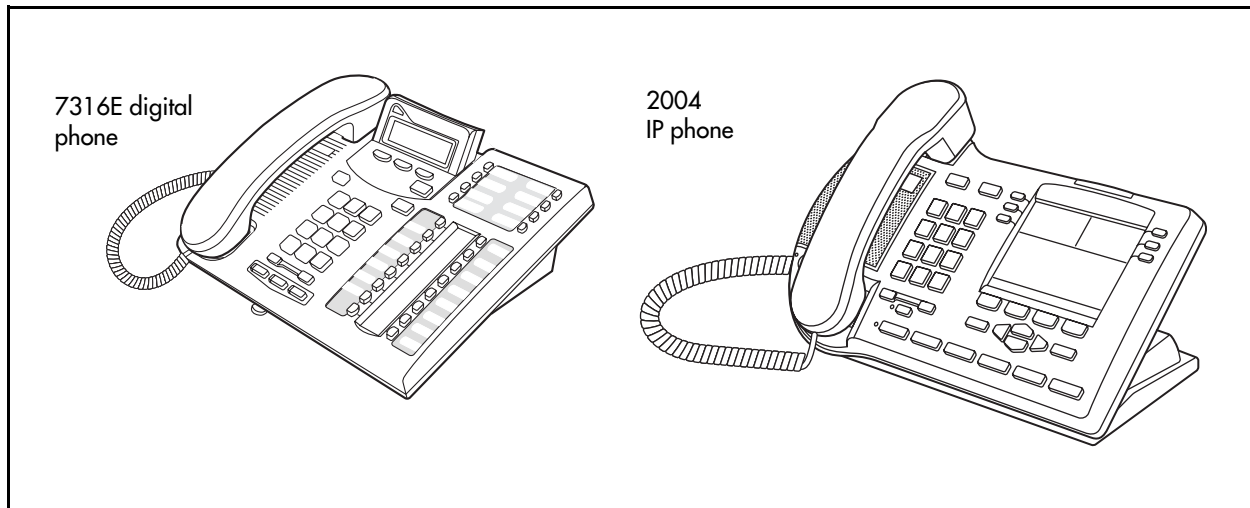
In addition, there are two default telset access passwords for the voicemail and call center telset menus. Refer to the *BCM 4.0 Administration Guide* for details.

Programming telephones

To access and use the telset configuration menus, you require a digital or IP telephone with a two-line display.

Both the 7316E digital phone and the 2004 IP phone, shown in [Figure 7](#), can be used for this purpose.

Figure 7 Digital phone and IP phone



Navigating the telset menus

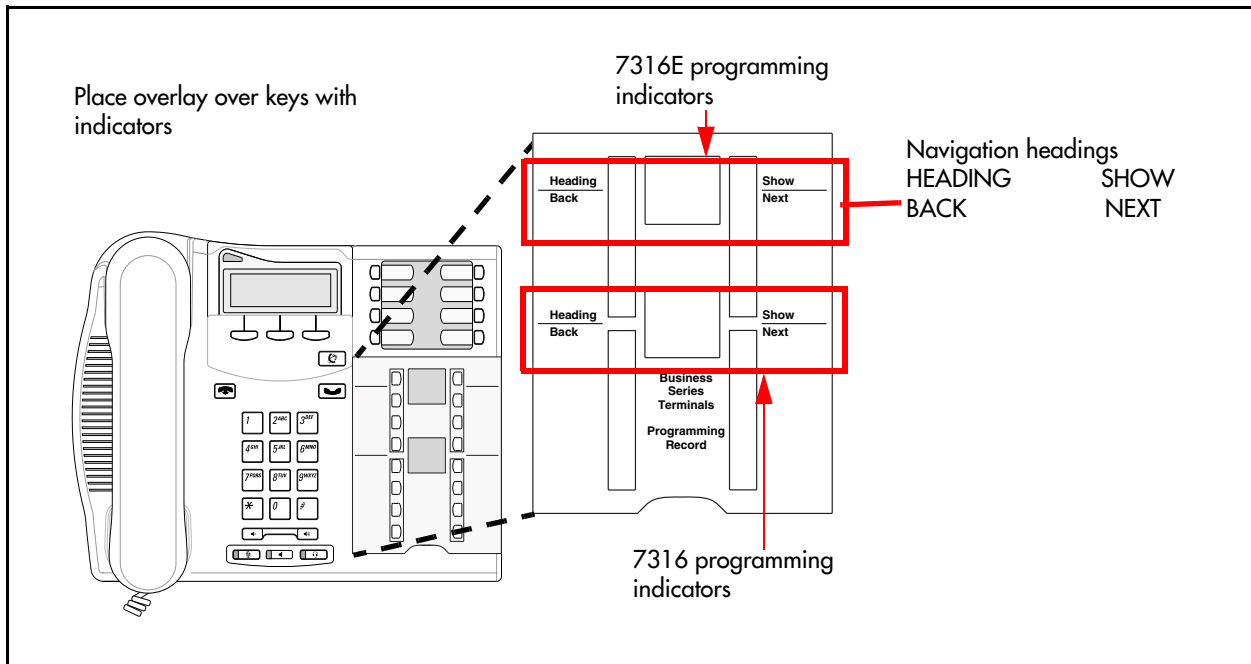
Digital and IP phones use slightly different methods of navigating through the telset menus. This section contains the following information:

- [“Using a digital phone to navigate” on page 21](#)
- [“Using an IP phone to navigate the menus” on page 22](#)
- [“What the navigation headings and directions mean” on page 23](#)
- [“Activating menu prompts” on page 23](#)

Using a digital phone to navigate

When you use a 7316 or 7316E digital phone for telset programming, a group of buttons on the telephone are used to move through programming headings and settings. The programming overlay is used to relabel the four buttons used during programming. The overlay is supplied with each telephone.

Figure 8 7316E digital phone with programming overlay

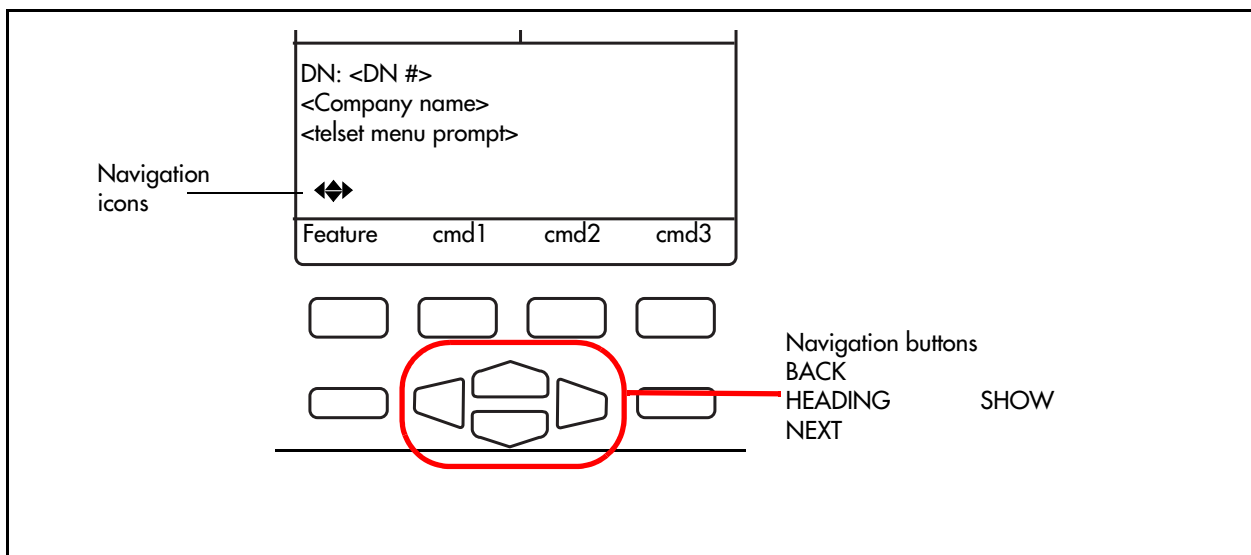


Using an IP phone to navigate the menus

IP telephones use the telephone directional buttons to move through the menu. The active navigation buttons are shown as a small icon on the far left beside the message prompt.

See [Figure 9](#).

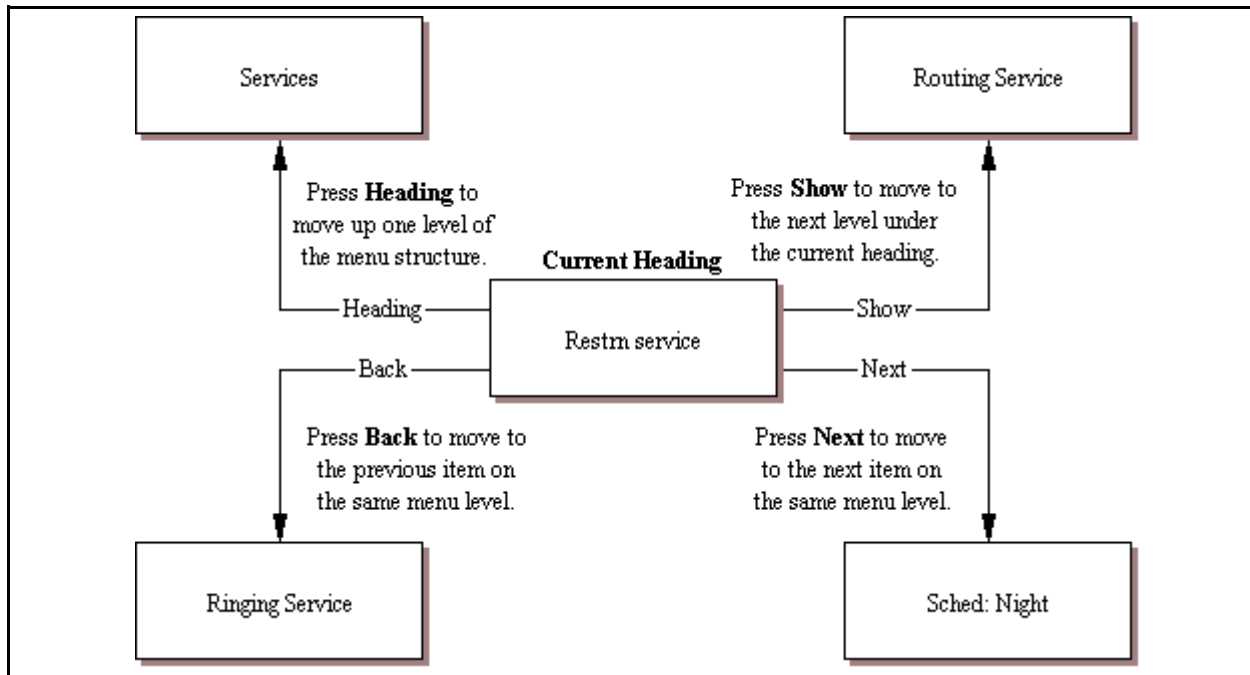
Figure 9 Display and buttons, IP phone



What the navigation headings and directions mean

Figure 10 shows how the headings on the overlay and the navigational buttons on the IP phone are used to navigate the programming menus.

Figure 10 How the navigation buttons work



Programming buttons are active or inactive at different stages of programming. On the digital phone, a button is active (meaning you can use that option), when the indicator next to it is lit (or).

On the IP phone, the navigation icons display the directional arrows that are active.

Activating menu prompts

Both telephones display the same menu prompts and action prompts that require the user to press the display buttons to perform actions related to the current menu choice. Refer to Figure 11 and Figure 12 for examples of each type of display.

Figure 11 Display and buttons, digital phone

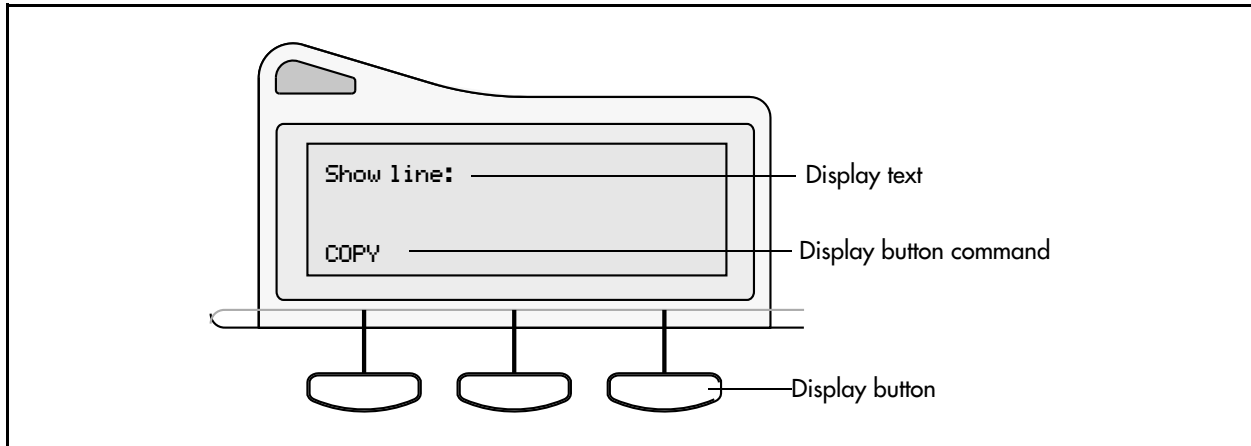
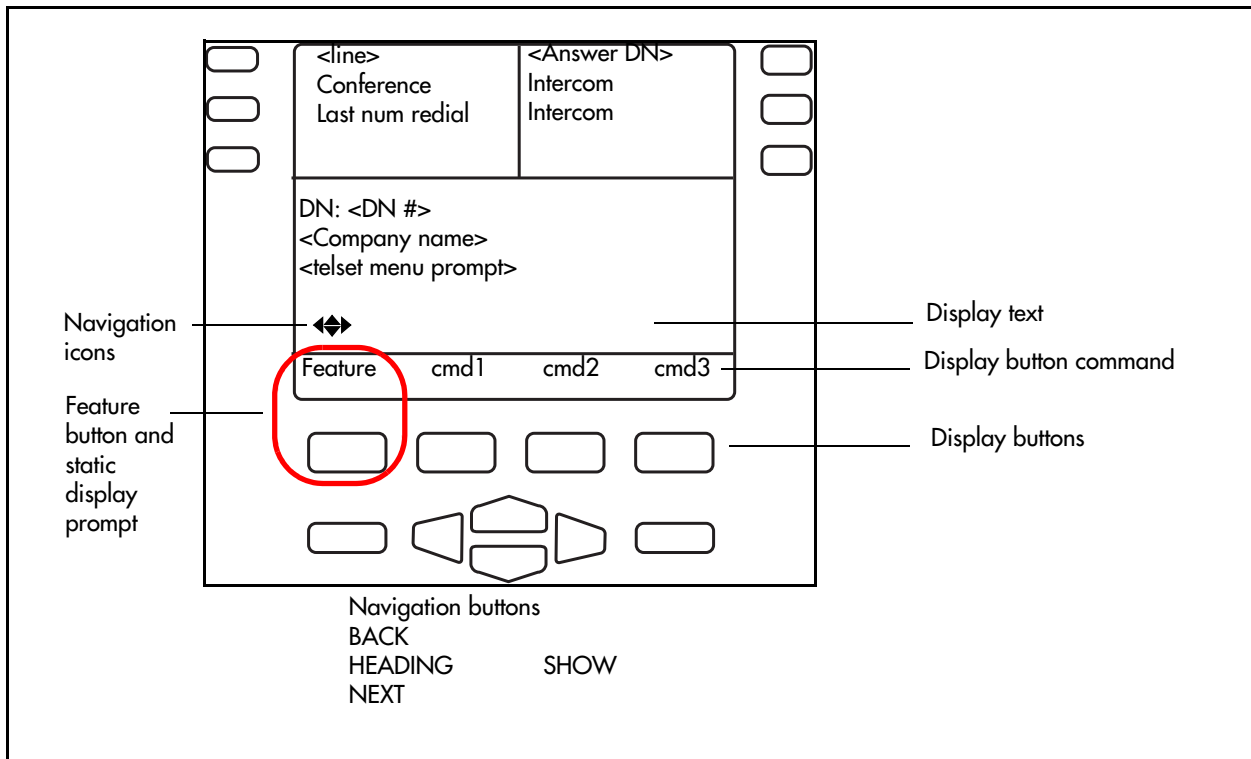


Figure 12 Display and buttons, IP phone

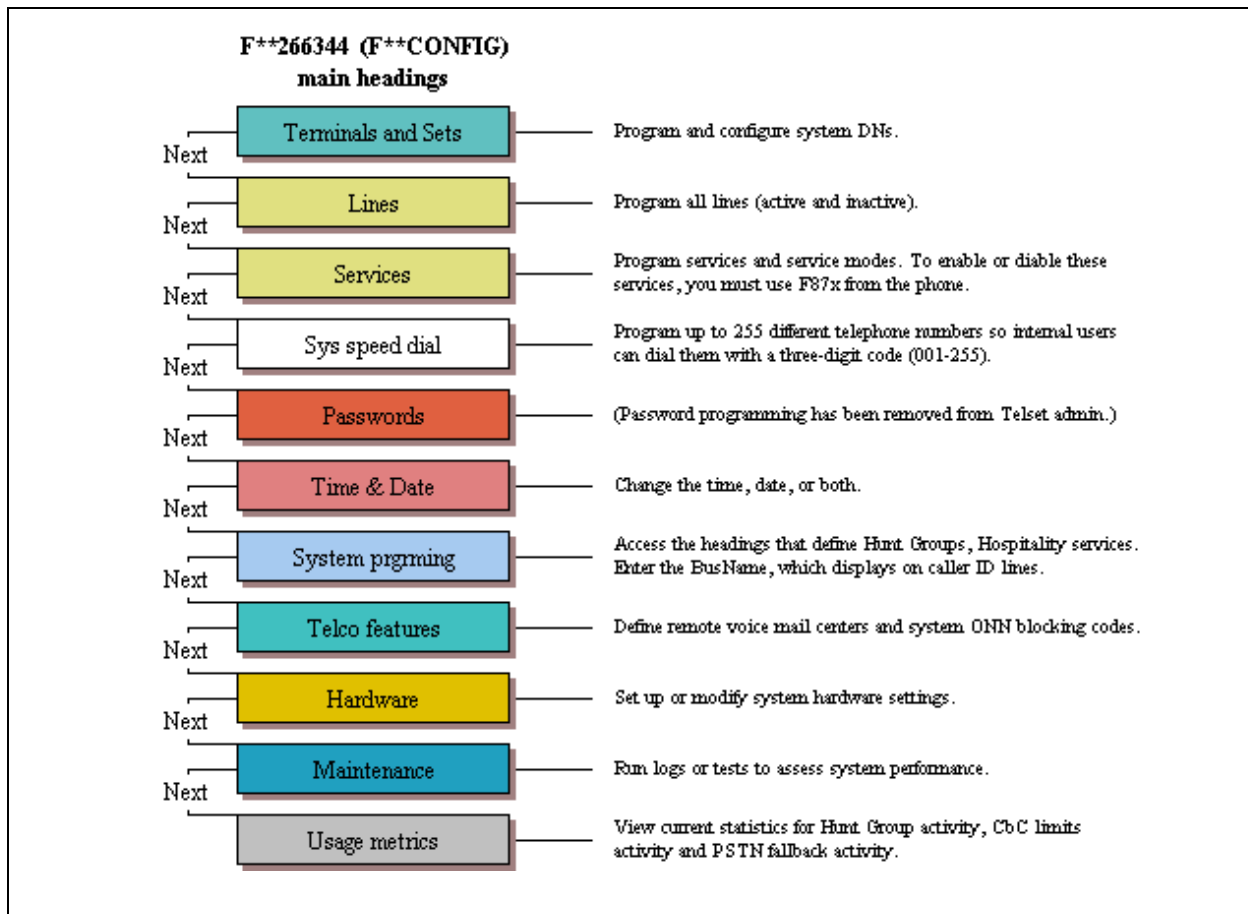


Top-level menu of the telset telephony configuration tree

Figure 13 describes the contents of each top-level menu on the FEATURE **266344 (**CONFIG) telephony configuration tree. Use the navigation buttons to move through the levels of the tree.

In this section, main headings and their menus are color-coded.

Figure 13 Top-level menus of **CONFIG telset interface



About the FEATURE **CONFIG menu system

The following pages provide a number of flow charts that show the various levels of the telset configuration tree. Note that the arrows indicate which navigation button is required to move to the next level.

- “Terminals and Sets” on page 26
- “Lines” on page 31
- “Services” on page 33

- [“System speed dials” on page 36](#)
- [“Time and Date” on page 38](#)
- [“System programming” on page 39](#)
- [“Telco features” on page 46](#)
- [“Hardware” on page 47](#)
- [“Maintenance” on page 49](#)
- [“Usage metrics” on page 51](#)

Terminals and Sets

[Figure 14](#) through [Figure 17](#) show the headings under the **Terminals and Sets** menu. These records are used to set up System DN's for Telephones, and system devices.

Figure 14 Terminals and Sets (Sheet 1 of 4)

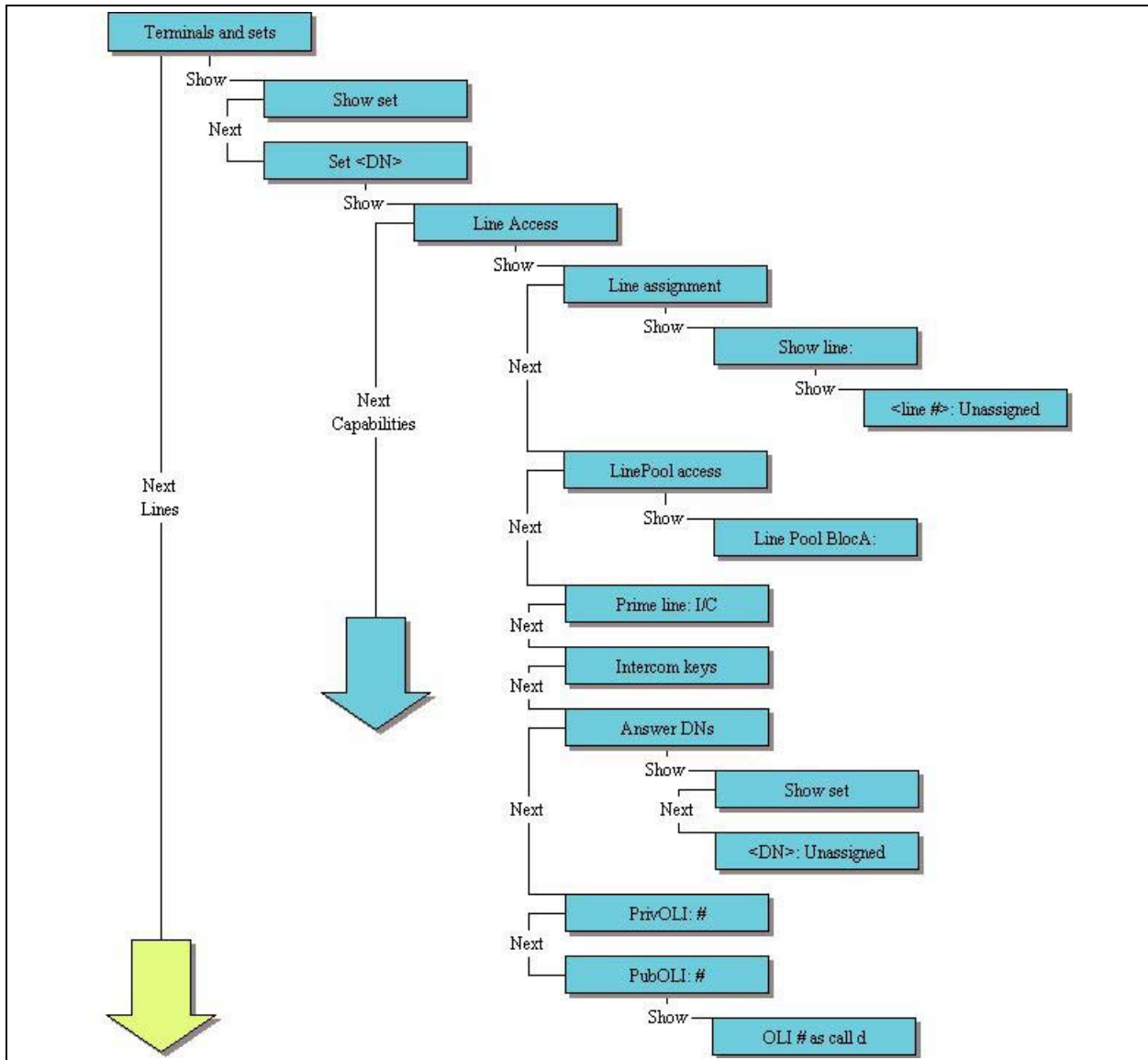


Figure 15 Terminals and Sets (Sheet 2 of 4)

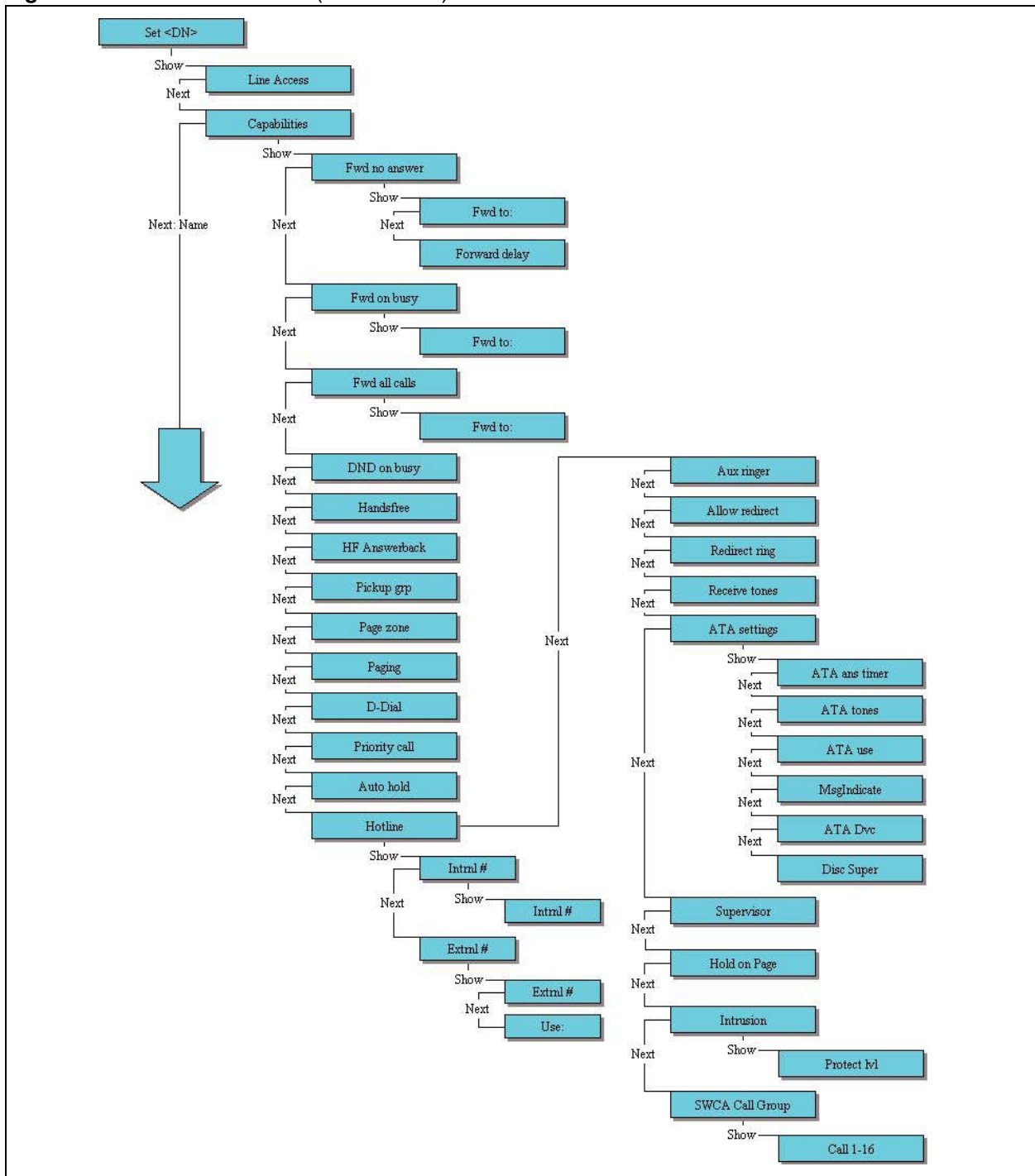


Figure 16 Terminals and Sets (Sheet 3 of 4)

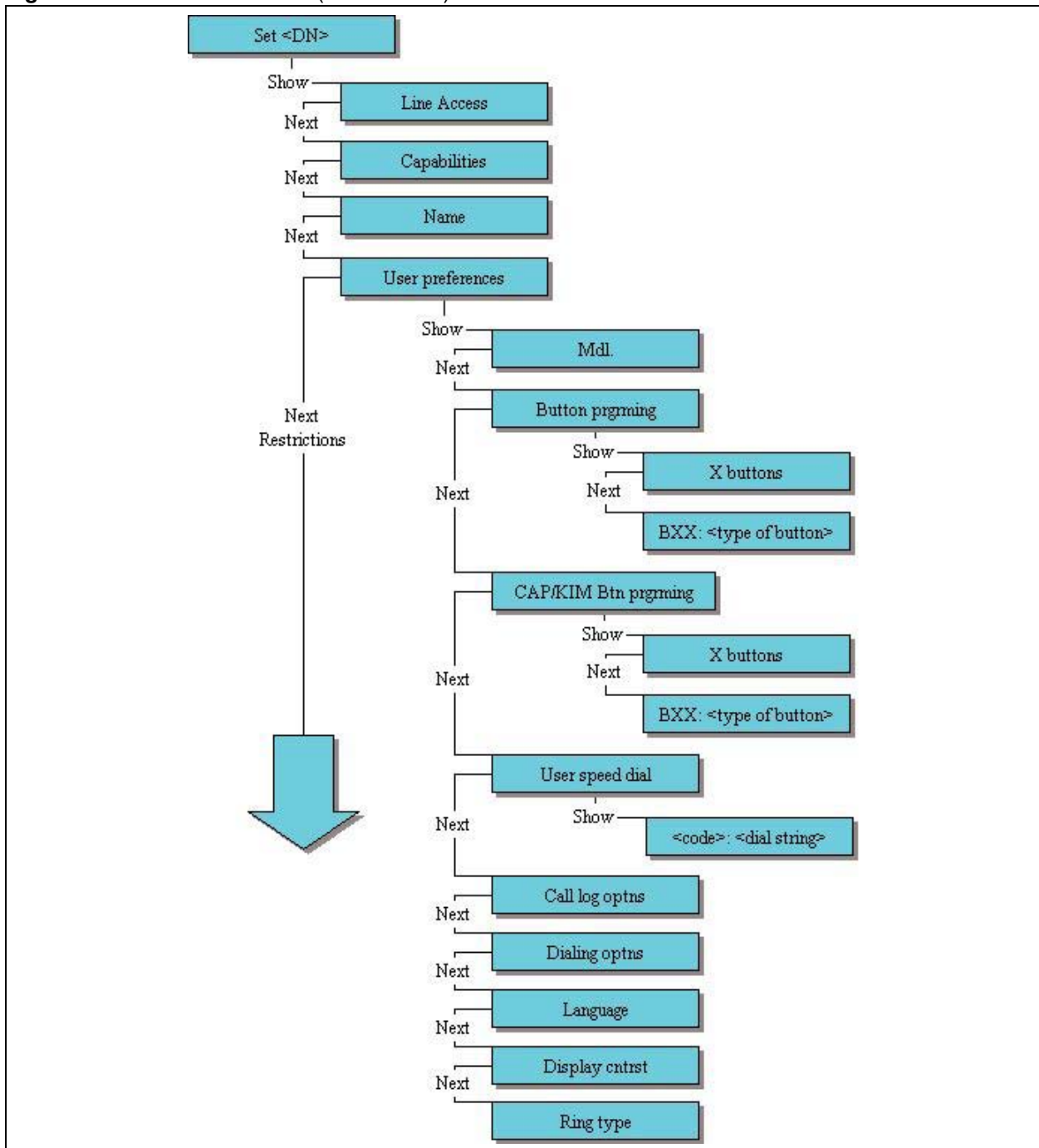
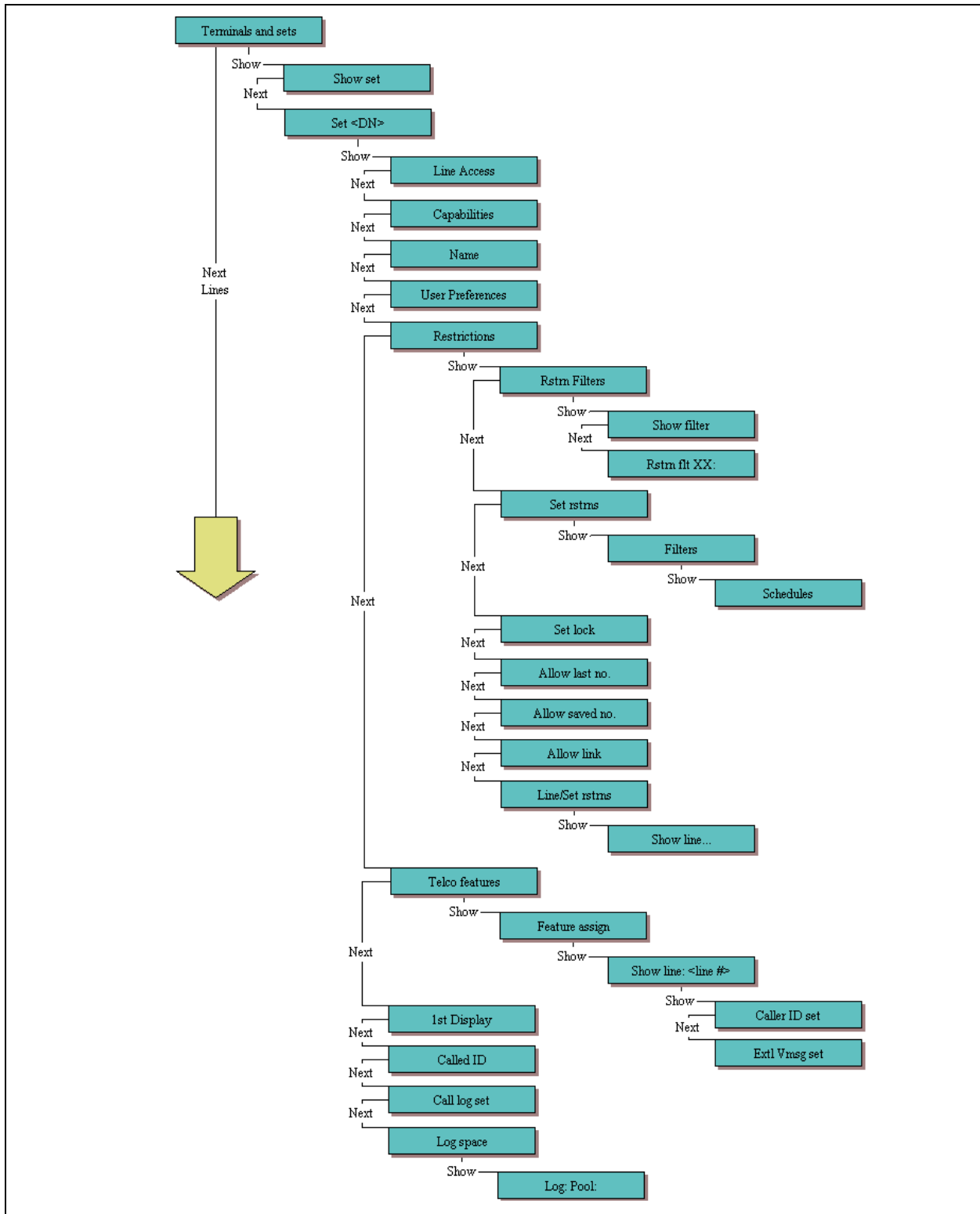


Figure 17 Terminals and Sets (Sheet 4 of 4)



Lines

Figure 18 and Figure 19 show the headings under the telset interface **Lines** heading. These records are used to set up individual lines that connect to the system from an external source.

Figure 18 Lines (Sheet 1 of 2)

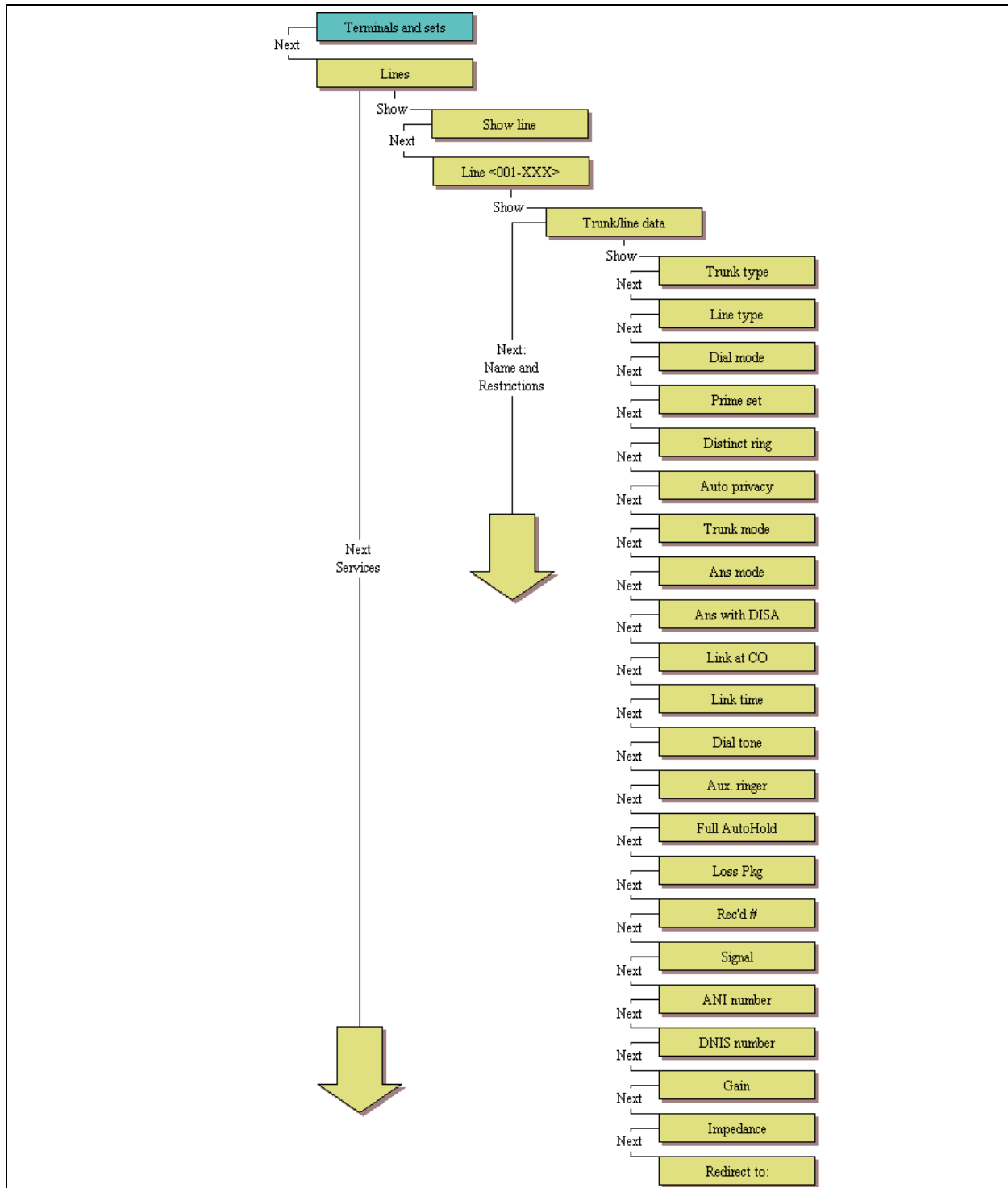
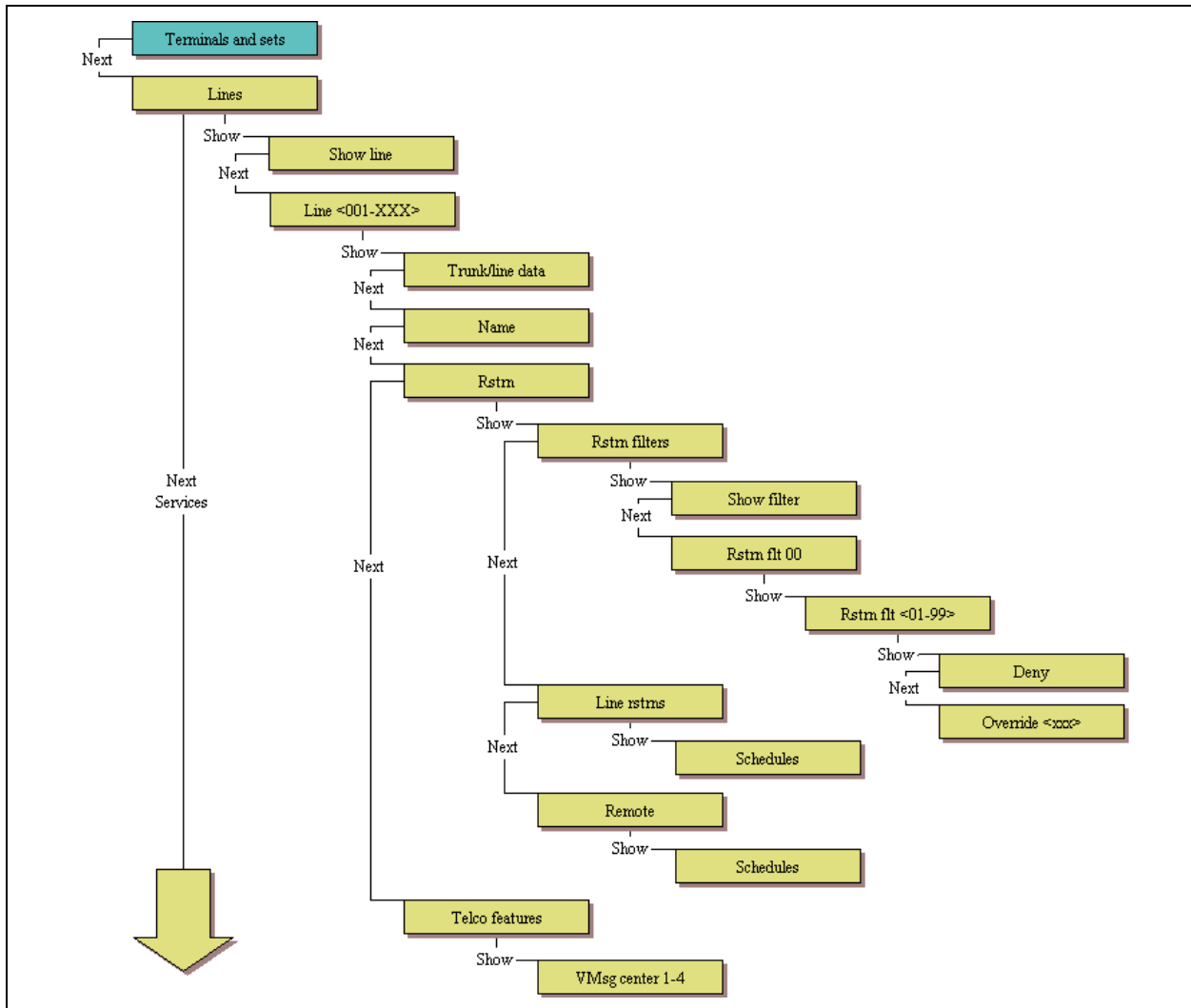


Figure 19 Lines (Sheet 2 of 2)



Services

Figure 20, Figure 21 and Figure 22 show the headings under the telset interface **Services** heading. These records are used to set up scheduling for ring groups, restrictions, and routing. The ring groups also are set up under this heading.

Figure 20 Services (Sheet 1 of 3)

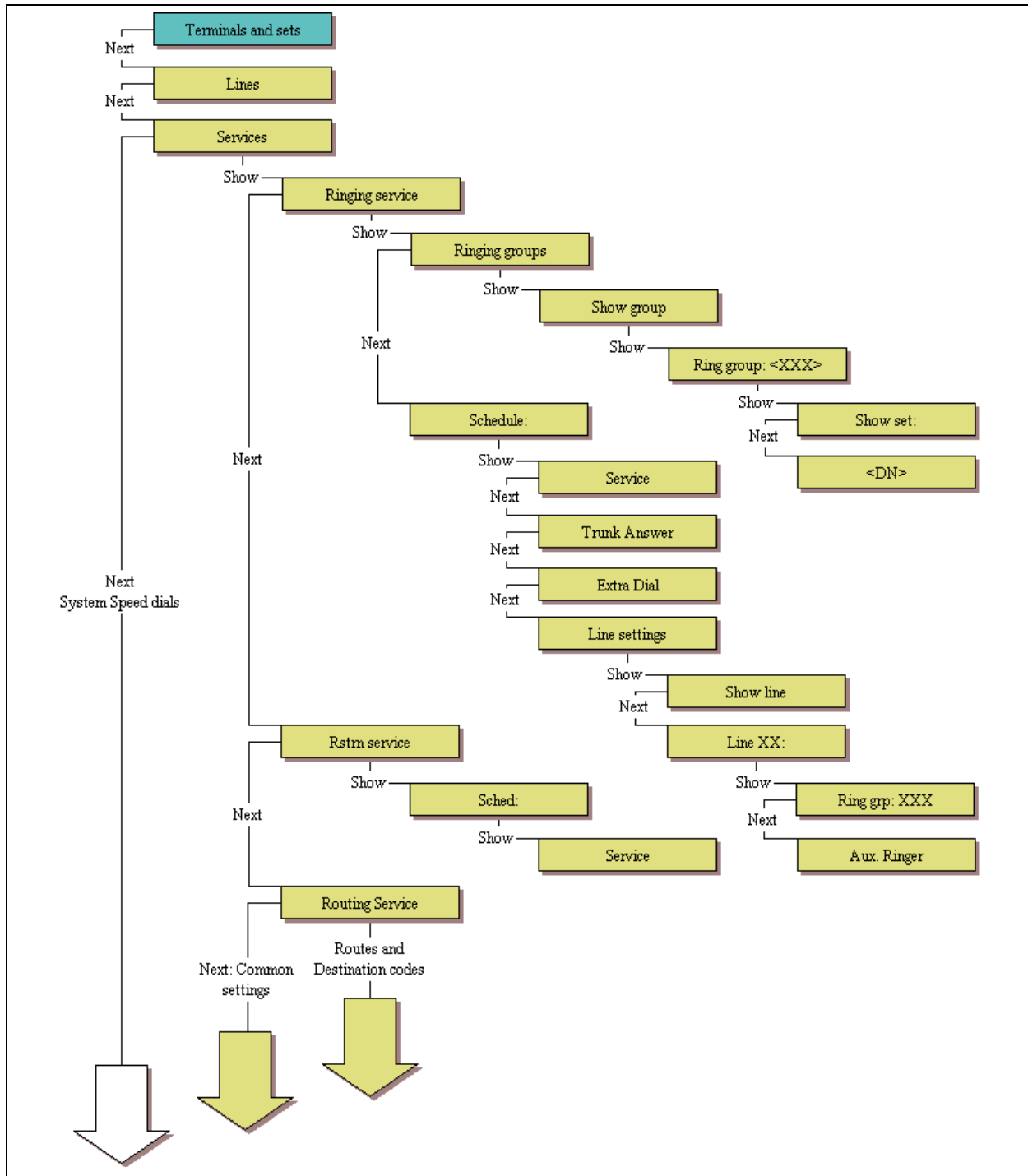


Figure 21 Services (Sheet 2 of 3)

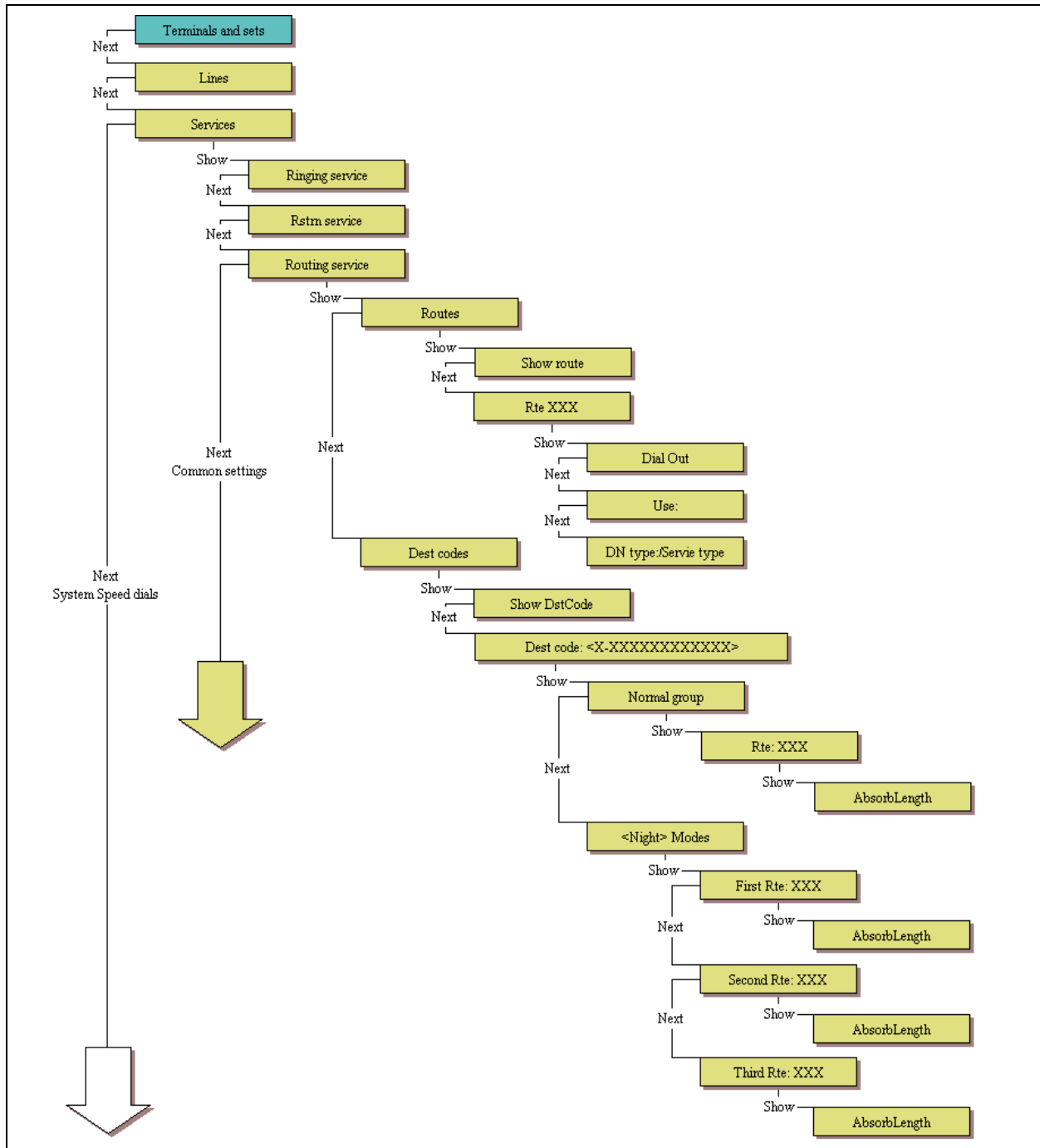
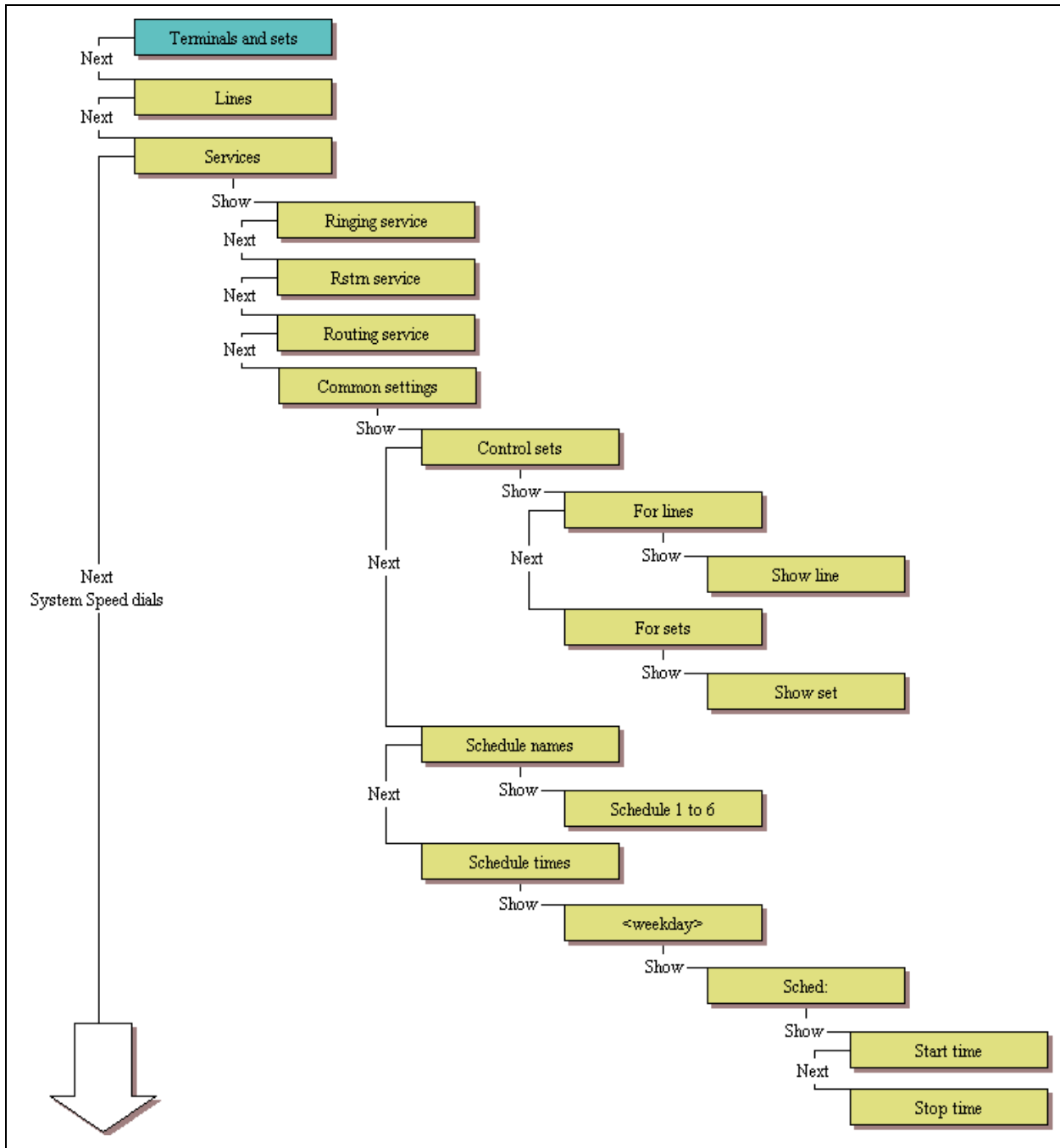


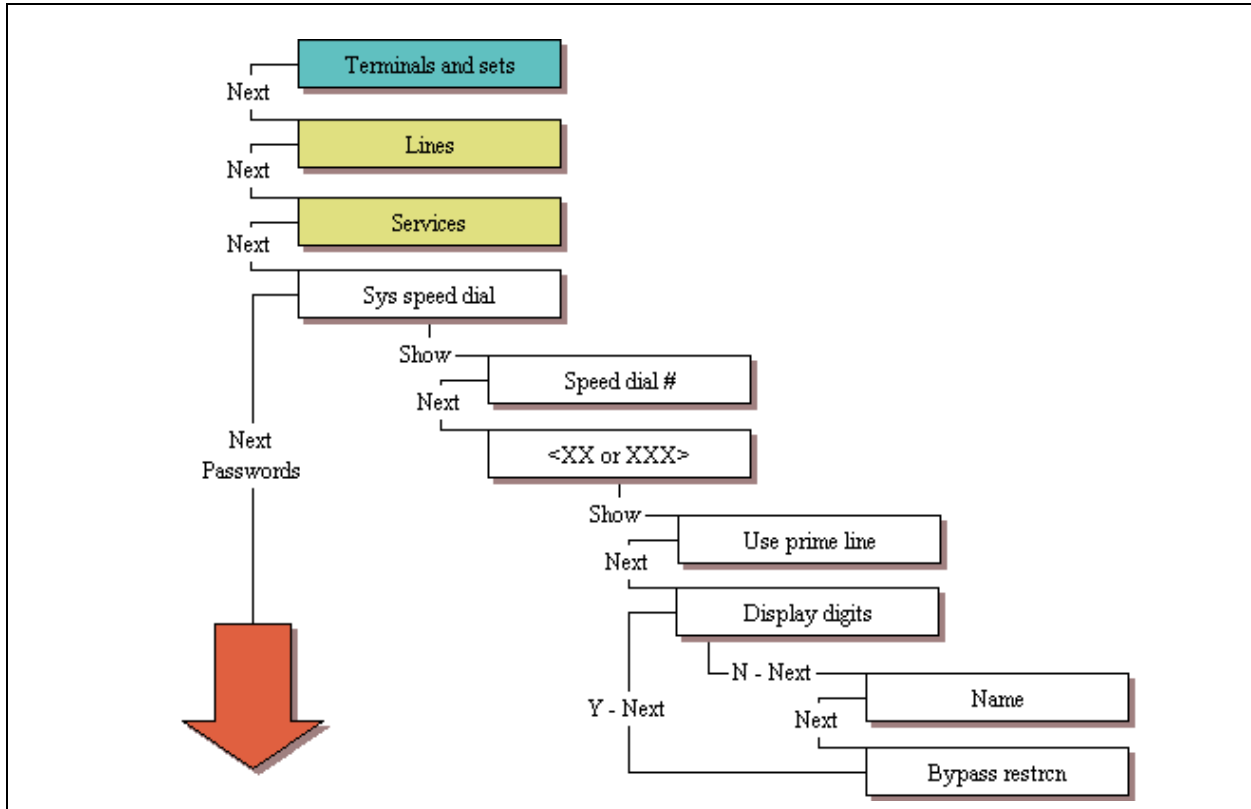
Figure 22 Services (Sheet3 of 3)



System speed dials

Figure 23 shows the headings under the telnet interface **System speed dials** heading. These records are used to set up lists of numbers that are accessed through a two- or three-digit code.

Figure 23 System speed dials

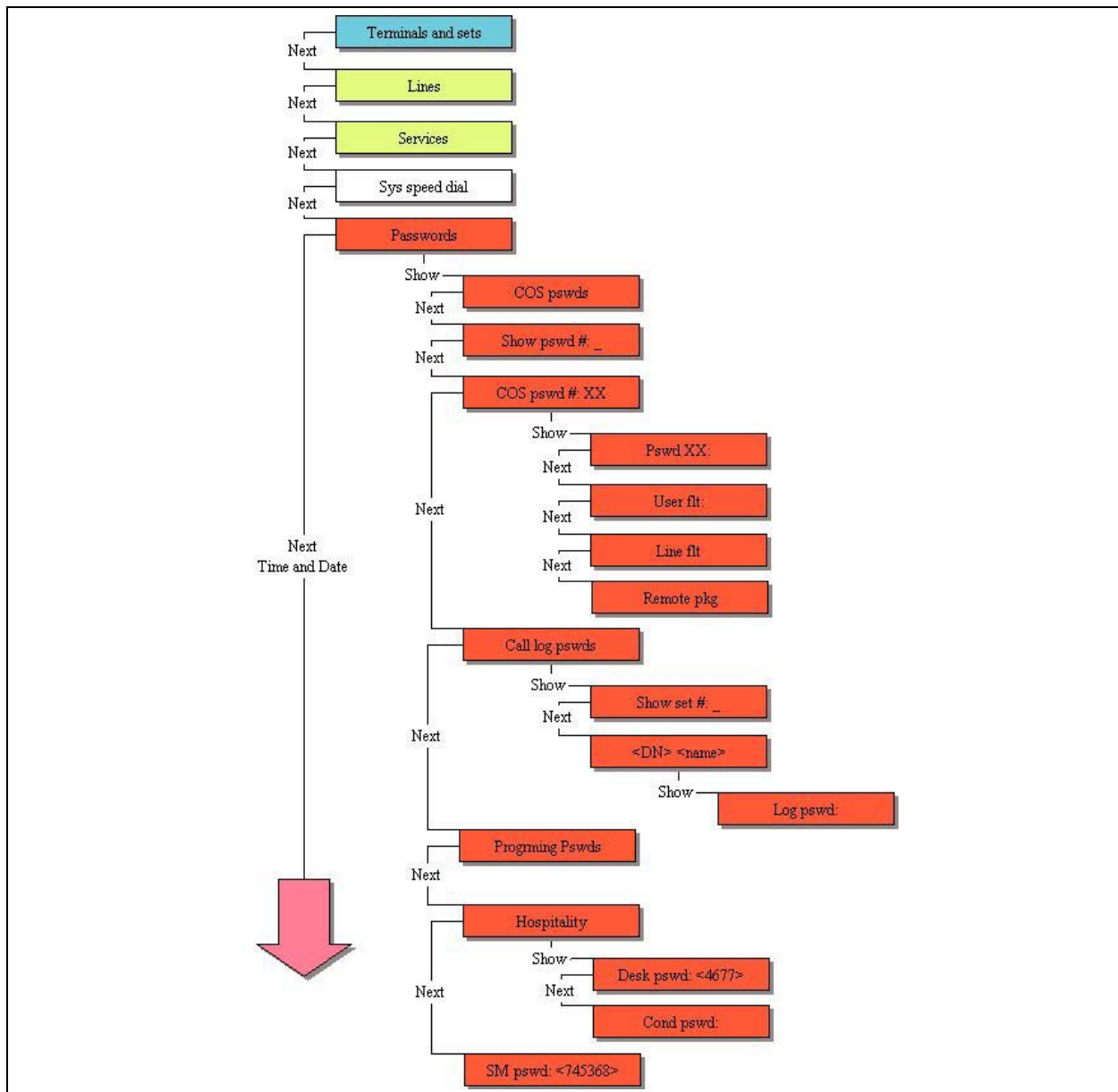


Passwords

Figure 24 shows the headings under the telset interface **Passwords** heading. These records are used to adjust the passwords for the following system features:

- COS passwords
- Call log passwords
- Hospitality passwords
- SM (silent monitor) password

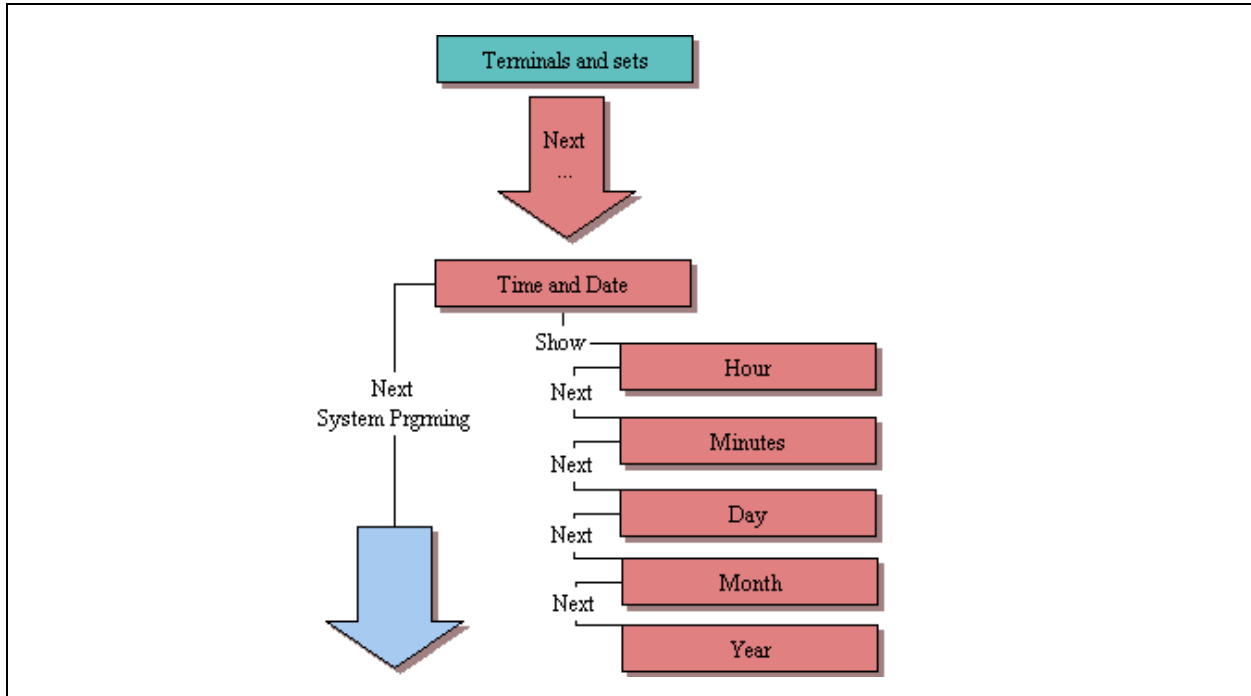
Figure 24 Feature passwords



Time and Date

Figure 25 shows the headings under the telset interface **Time and Date** heading. These records are used to adjust the time and date for the system. This is the time and date that appears on each telephone.

Figure 25 Time and Date



System programming

Figure 26 through Figure 32 shows the headings under the telset interface **System prgrming** heading. These records are used to program global telephony settings. This includes the special features for Hunt groups and Hospitality services.

Figure 26 System prgming (Sheet 1 of 7)

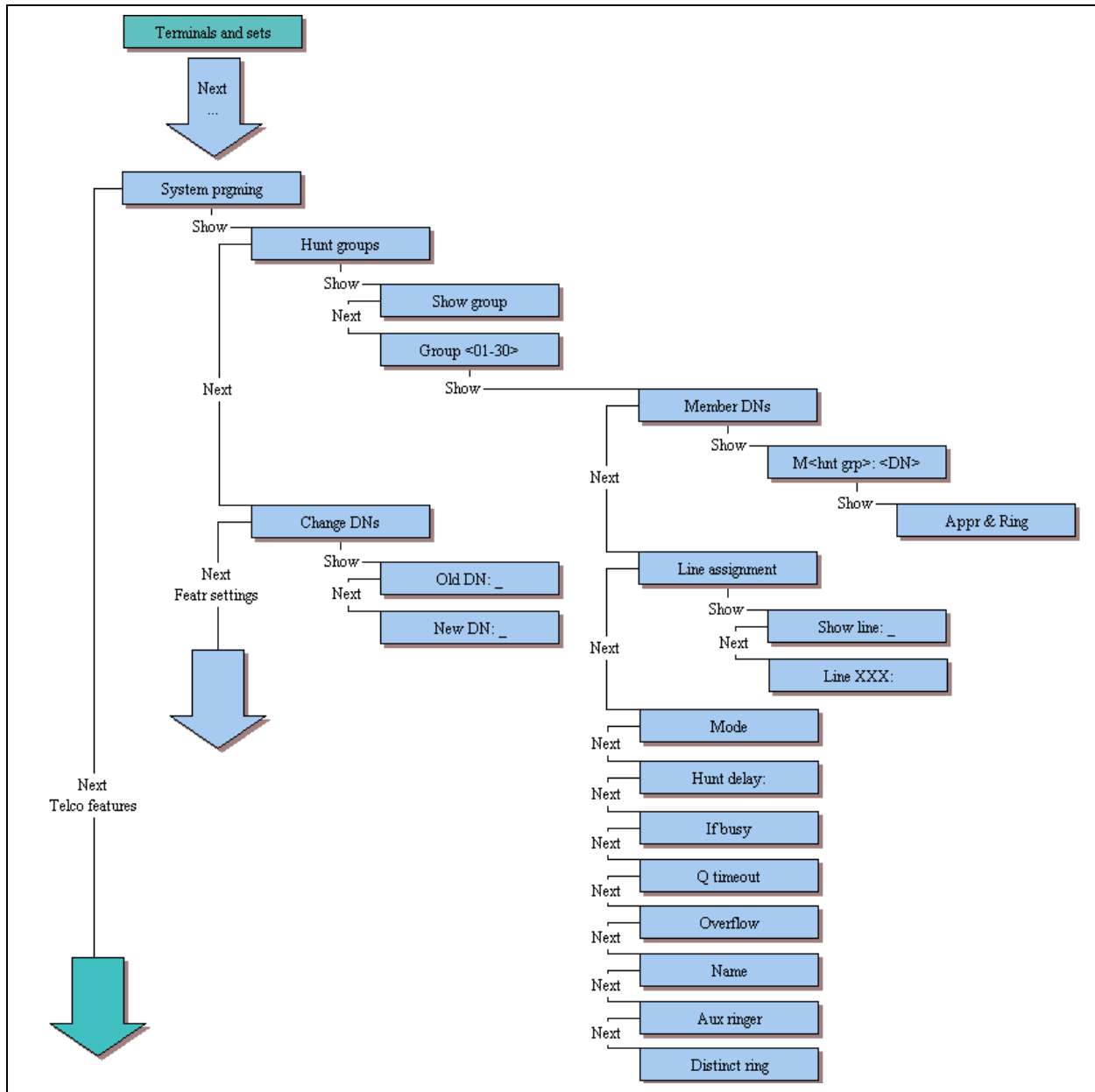


Figure 27 System prgming (Sheet 2 of 7)

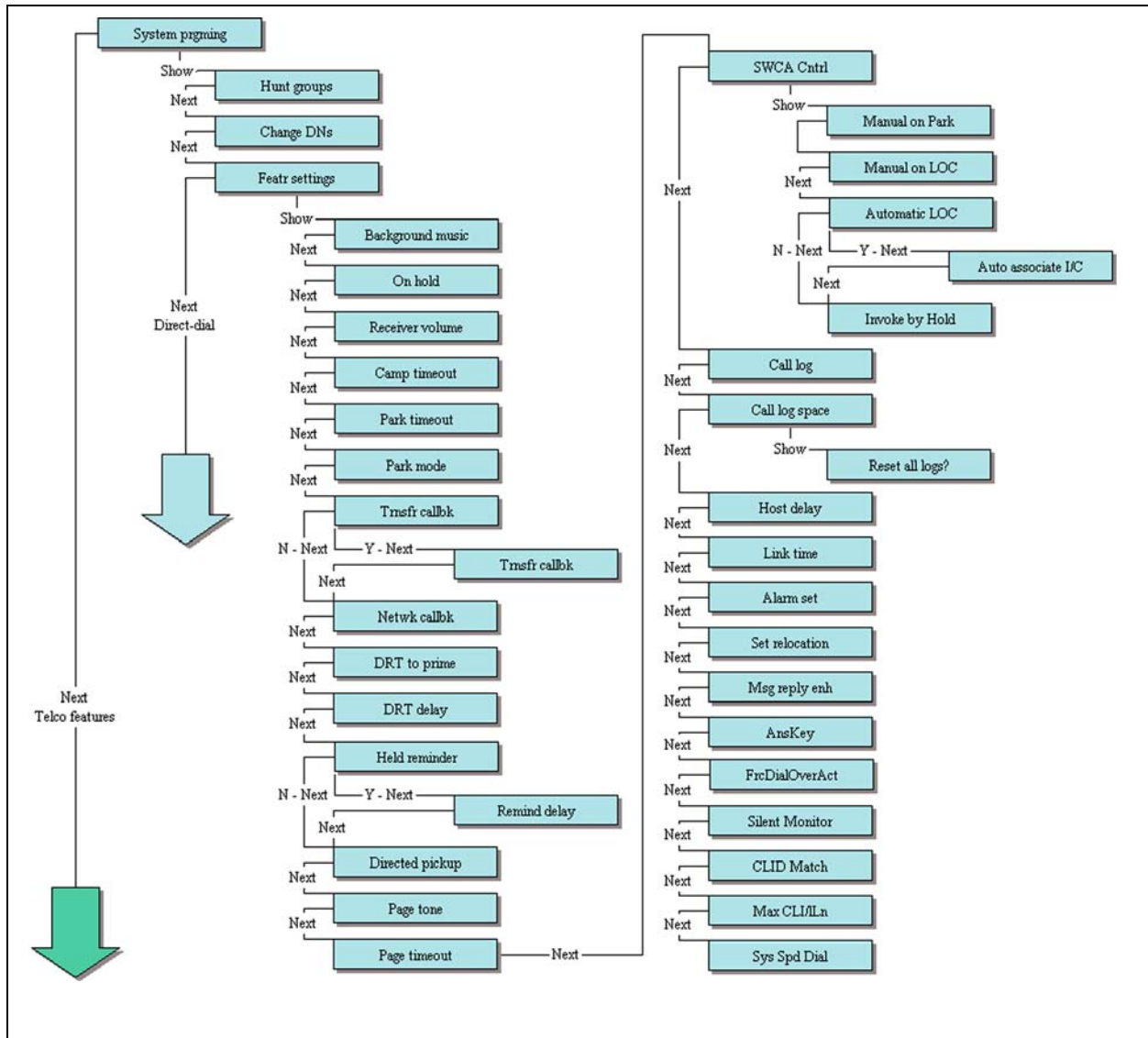


Figure 28 System prgming (page 3 of 7)

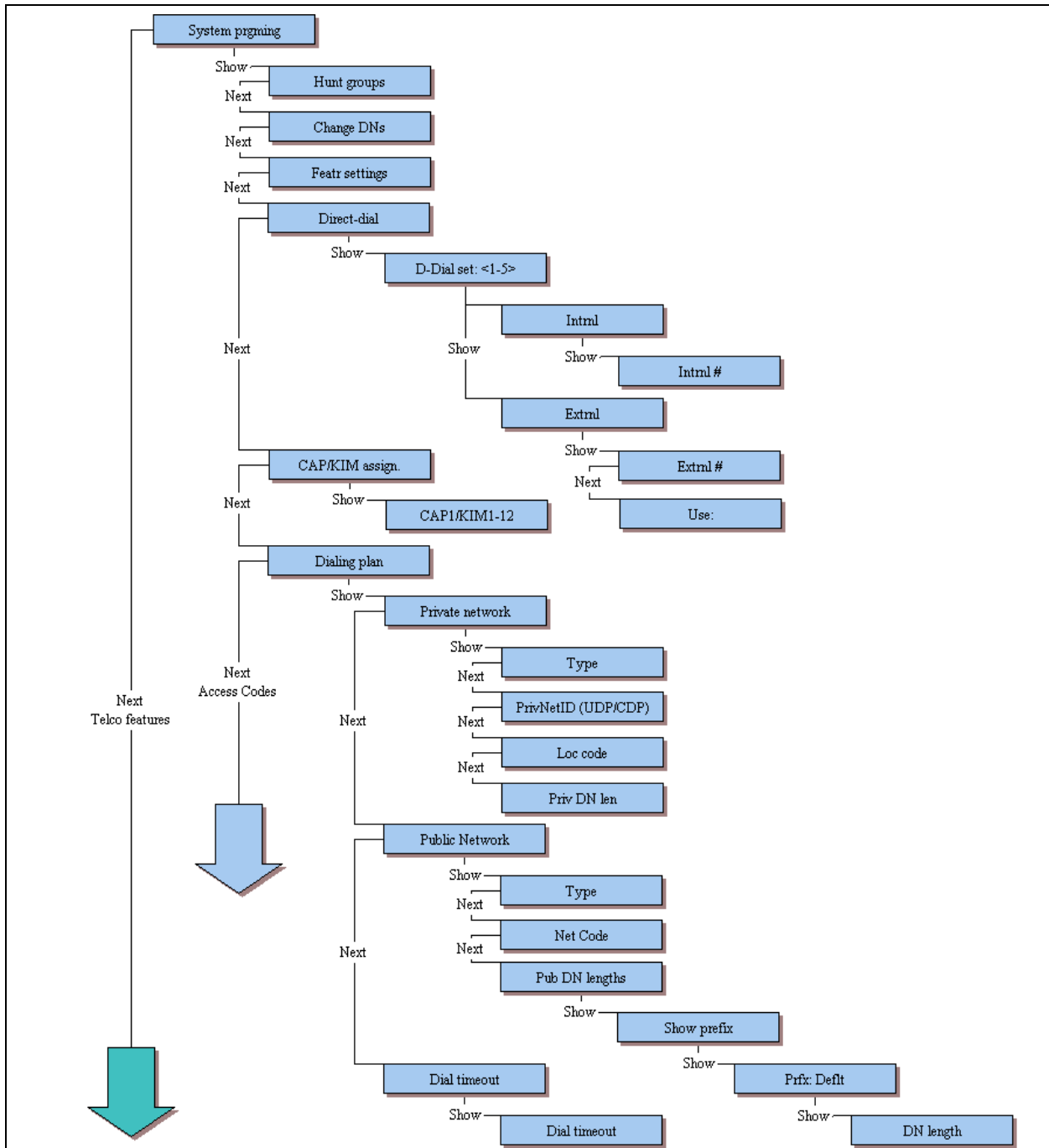


Figure 29 System prgming (Sheet 4 of 7)

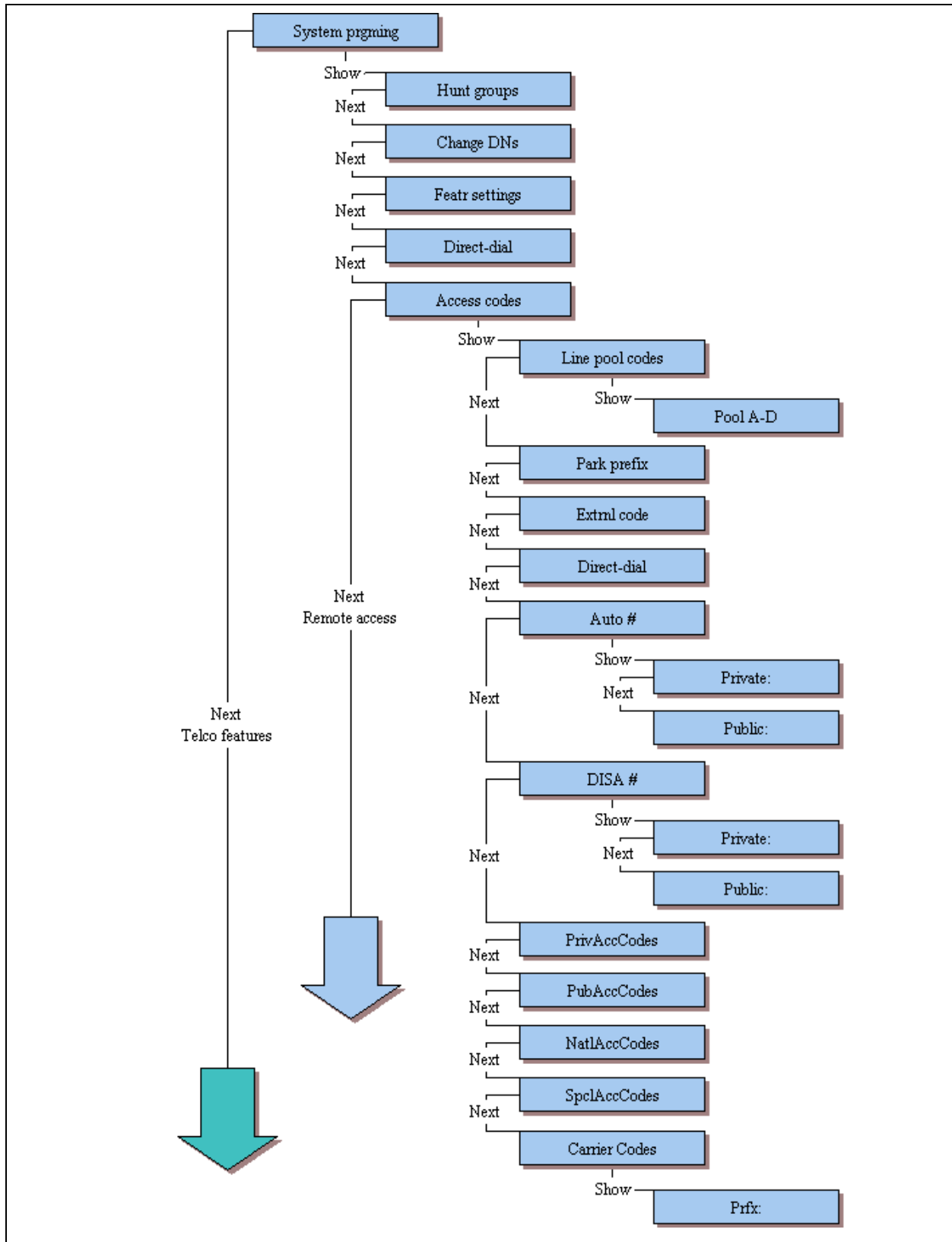


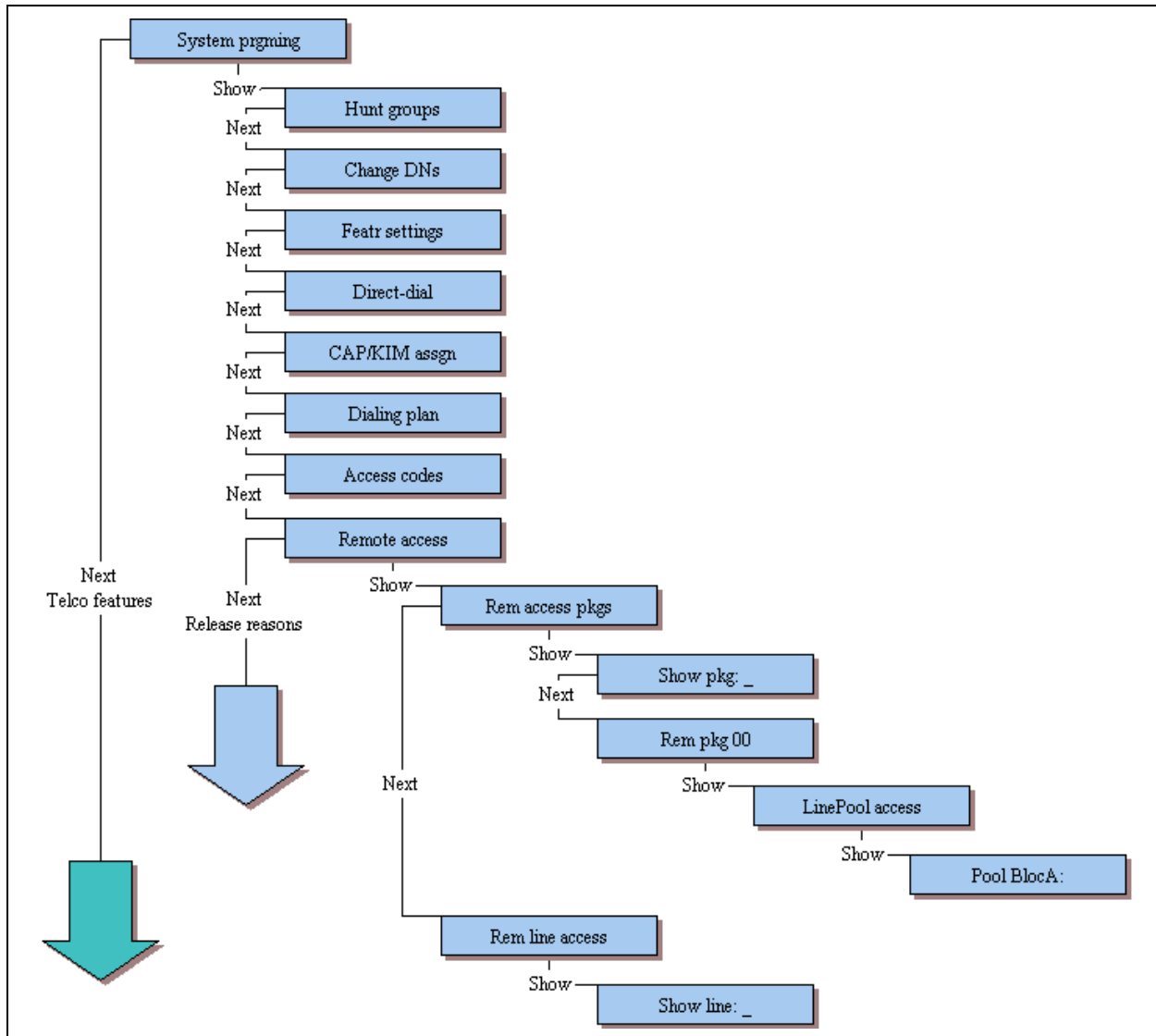
Figure 30 System prgming (page 5 of 7)

Figure 31 System prgming (Sheet 6 of 7)

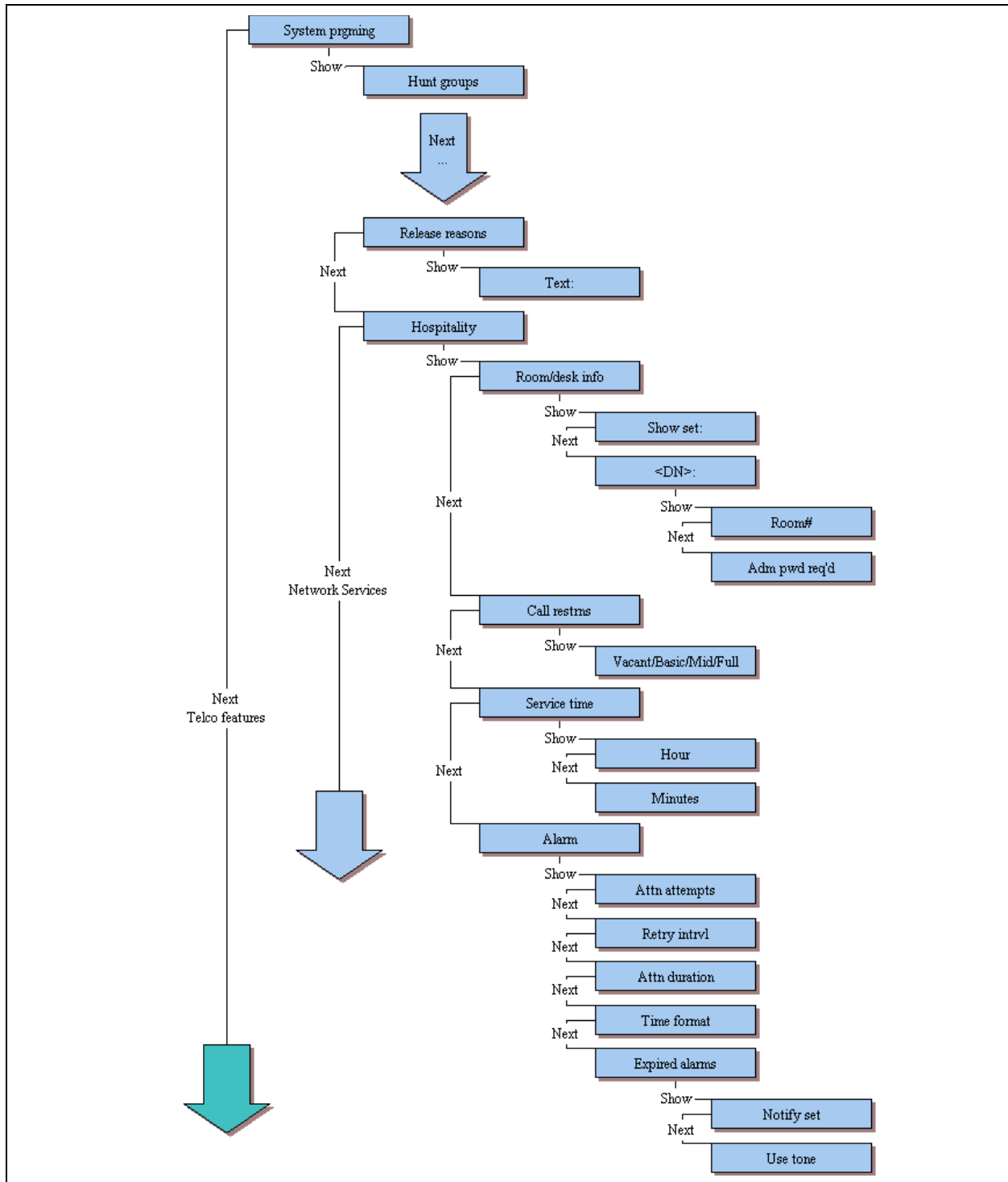
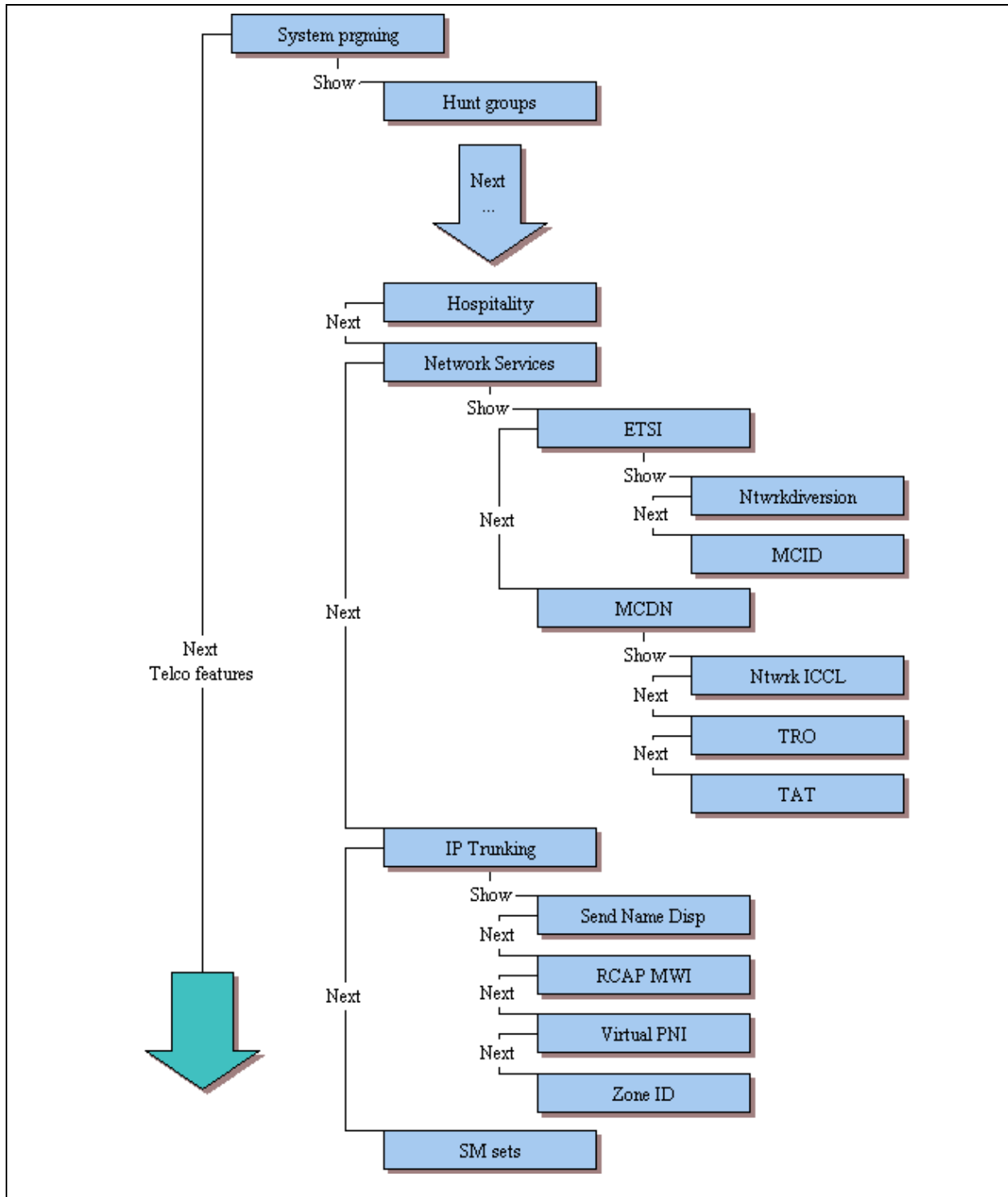


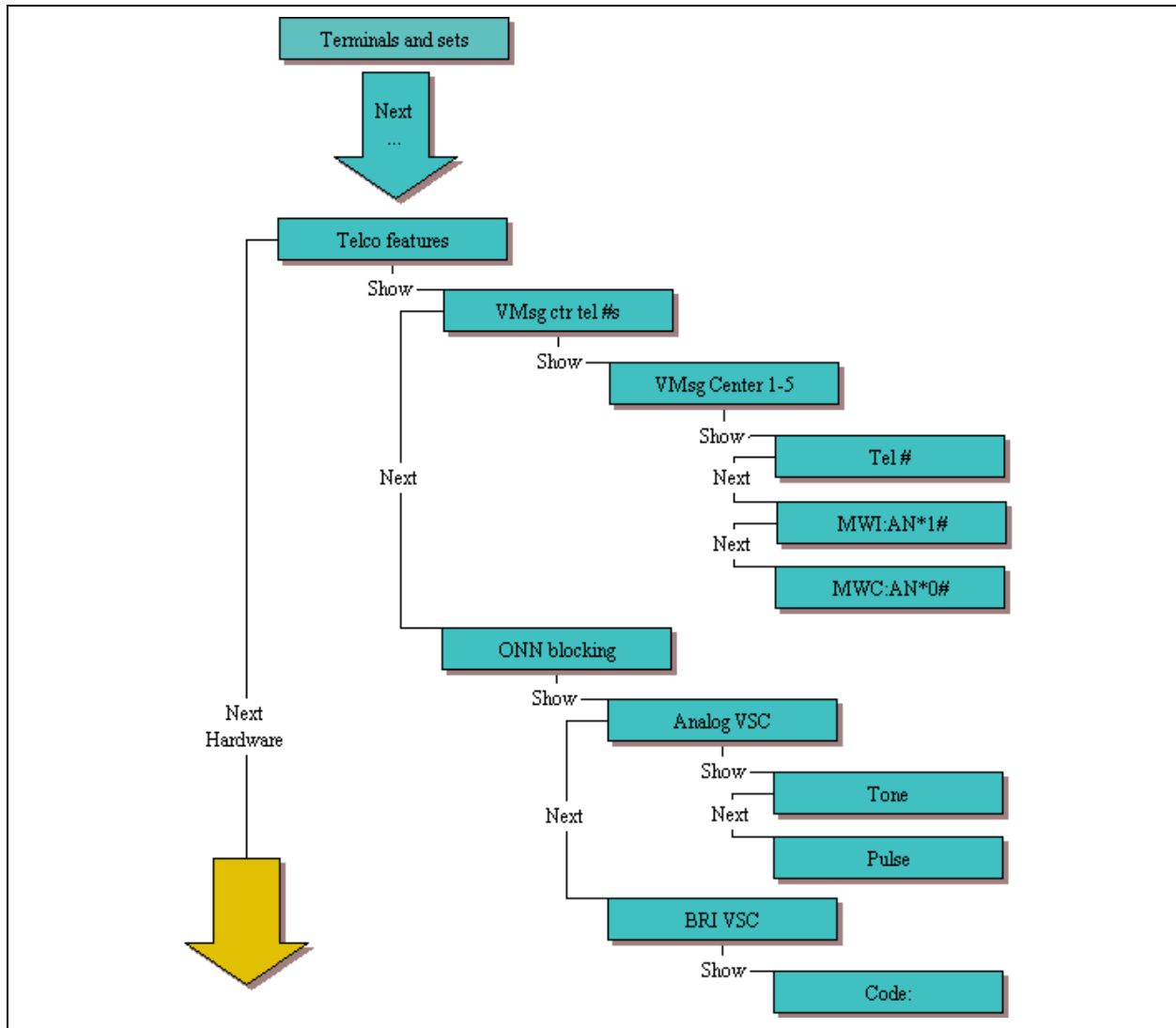
Figure 32 System prgming (Sheet 7 of 7)



Telco features

Figure 33 shows the headings under the telset interface **Telco features** heading. These records are used to program external voicemail numbers, and to program the outgoing name and number (ONN) blocking for analog and BRI trunks.

Figure 33 Telco features



Hardware

Figure 34 and Figure 35 show the headings under the telset interface **Hardware** heading. These records are used to program the ports on the main unit and any modules connected to the system through the expansion units.

Figure 34 Hardware (Sheet 1 of 2)

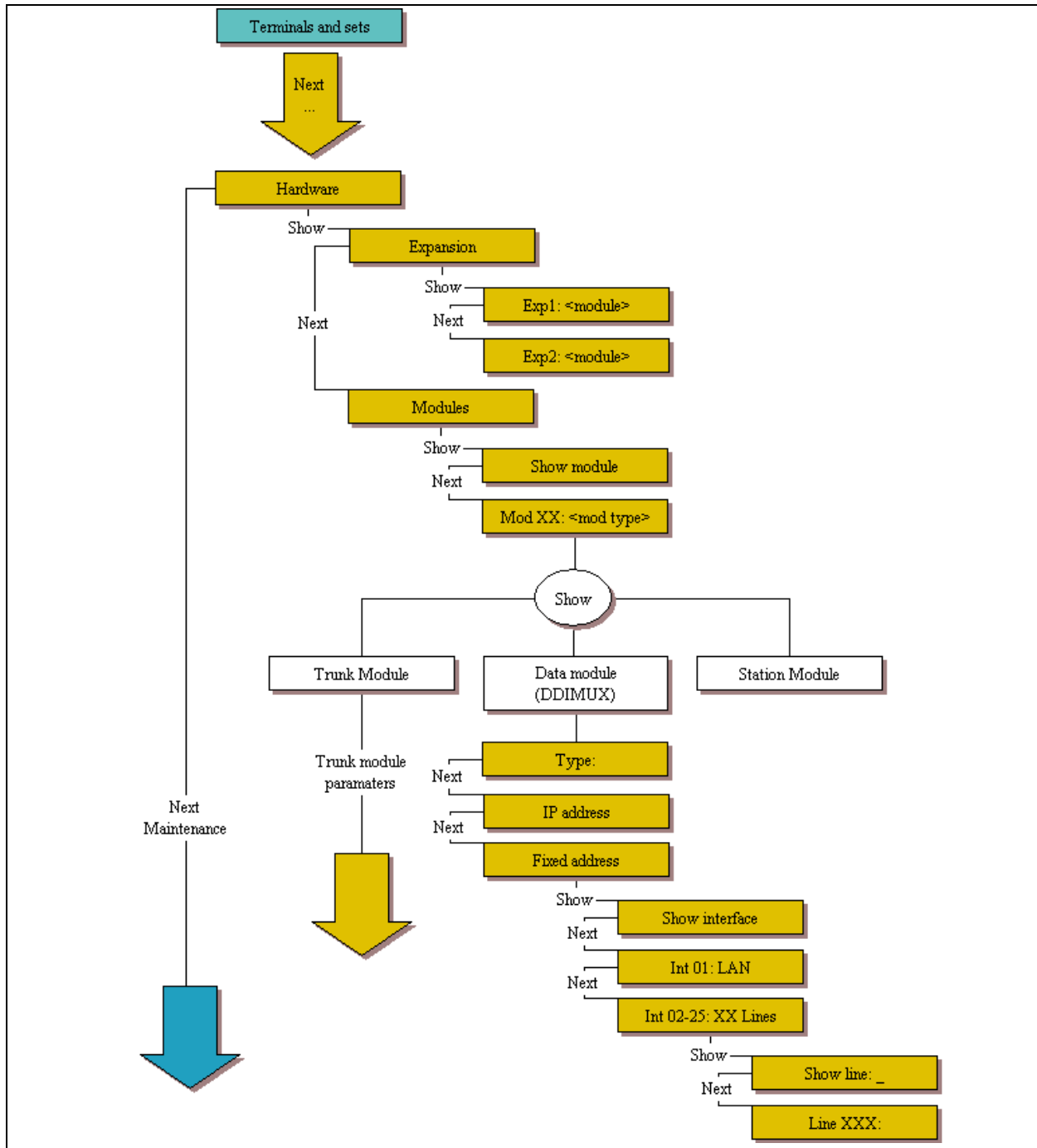
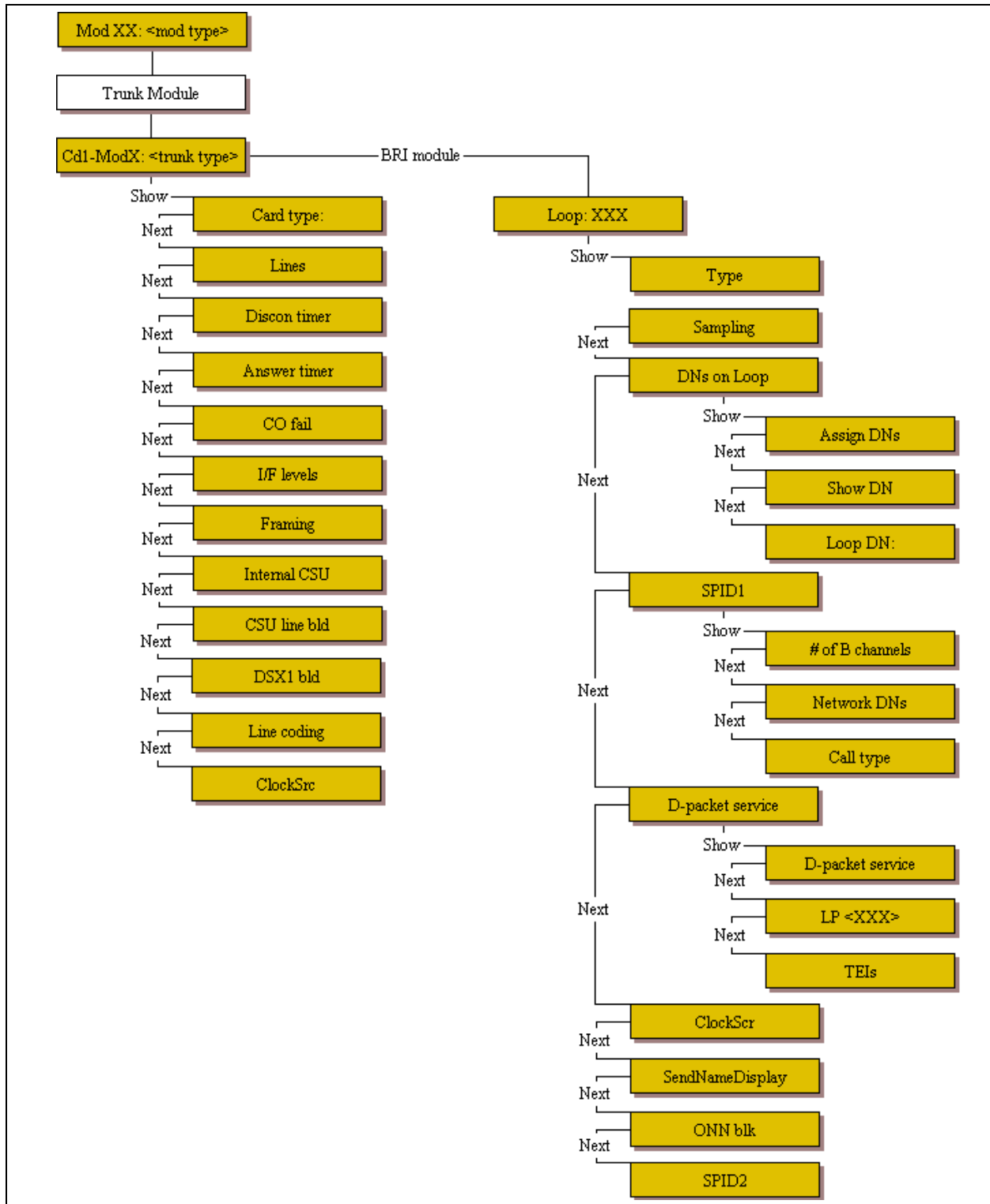


Figure 35 Hardware (page 2 of 2)



Maintenance

Figure 36 shows the headings under the telset interface **Maintenance** heading. These records are used to test or view statistics about the telephony system.

Figure 36 Maintenance (Sheet 1 of 2)

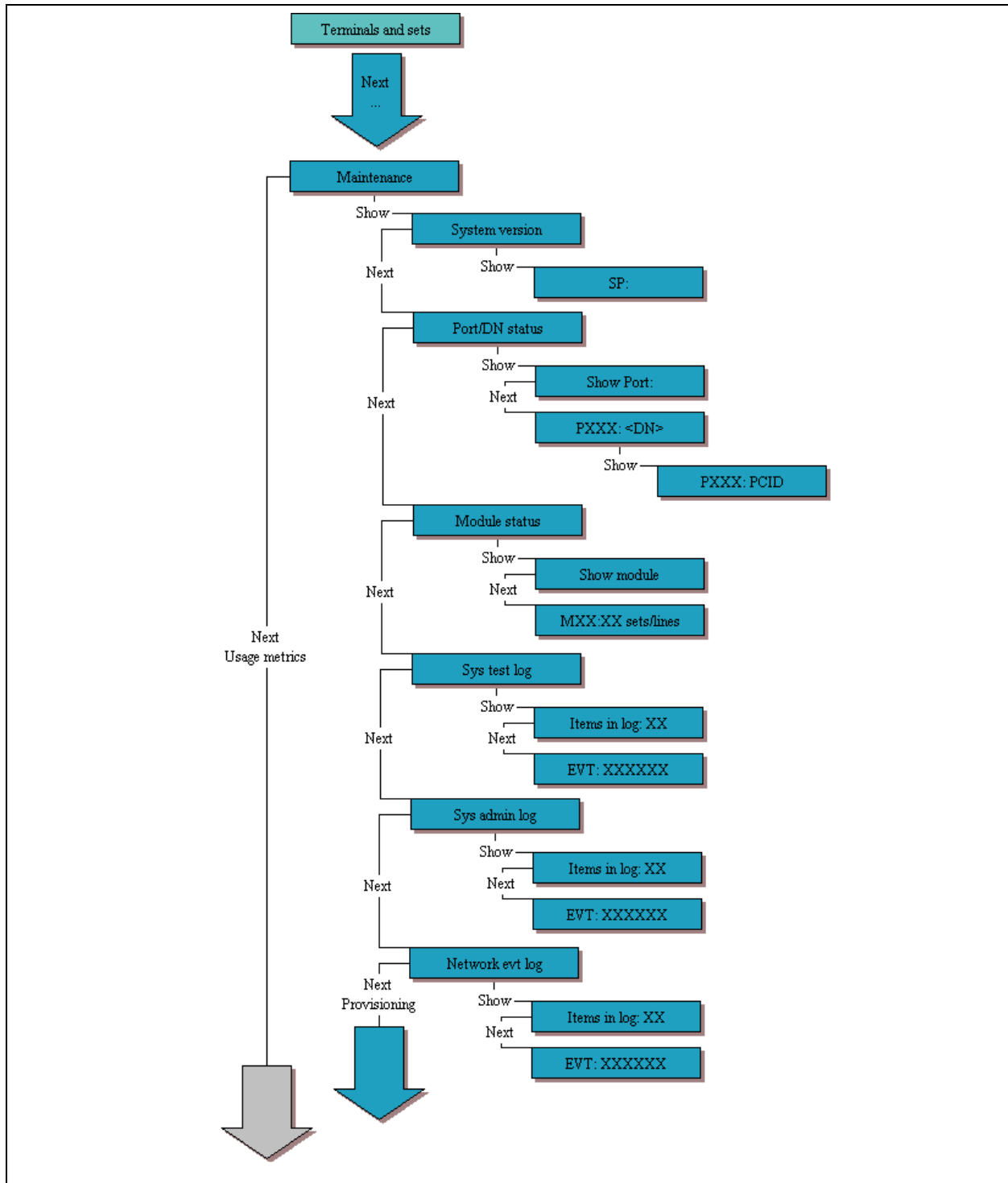
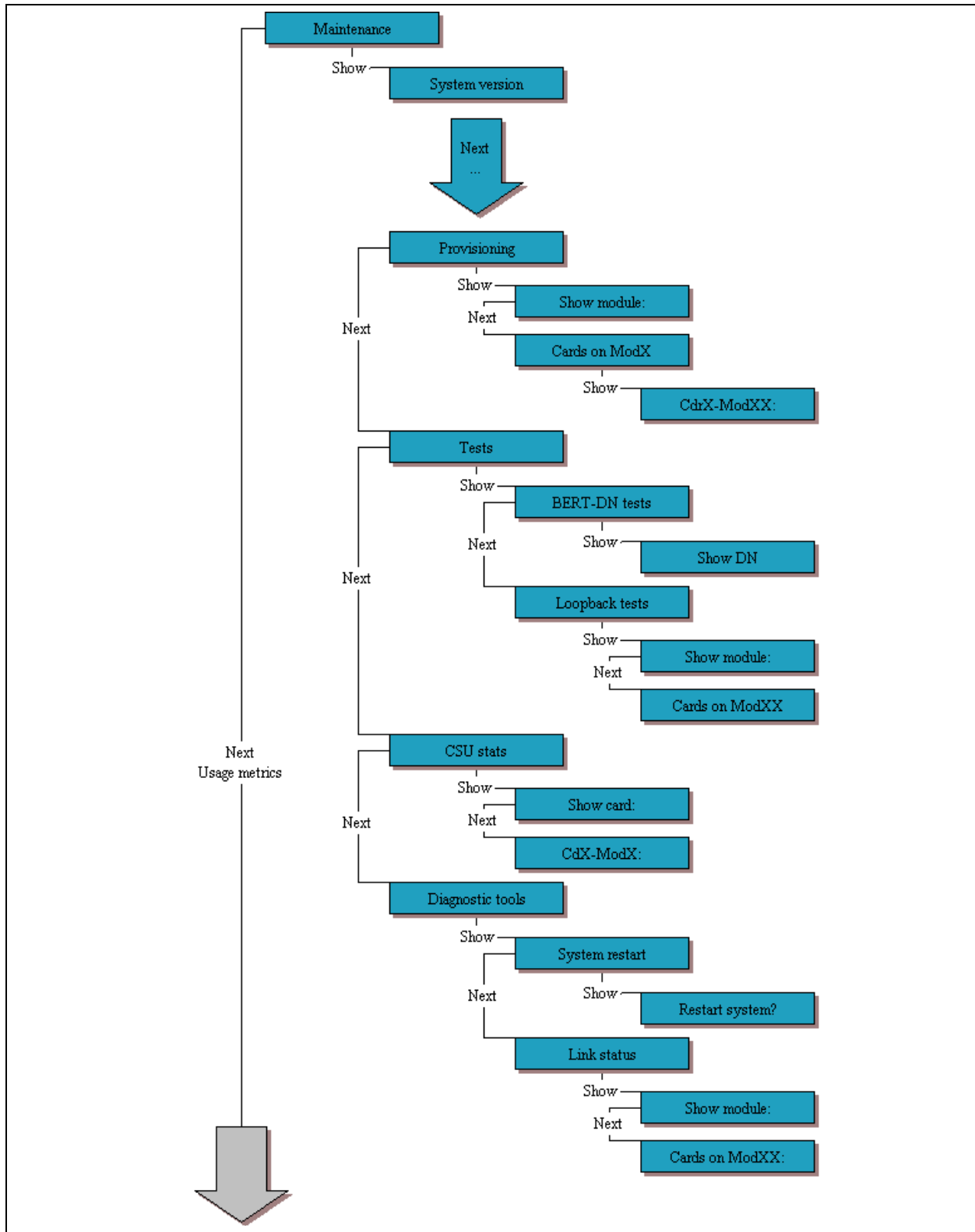


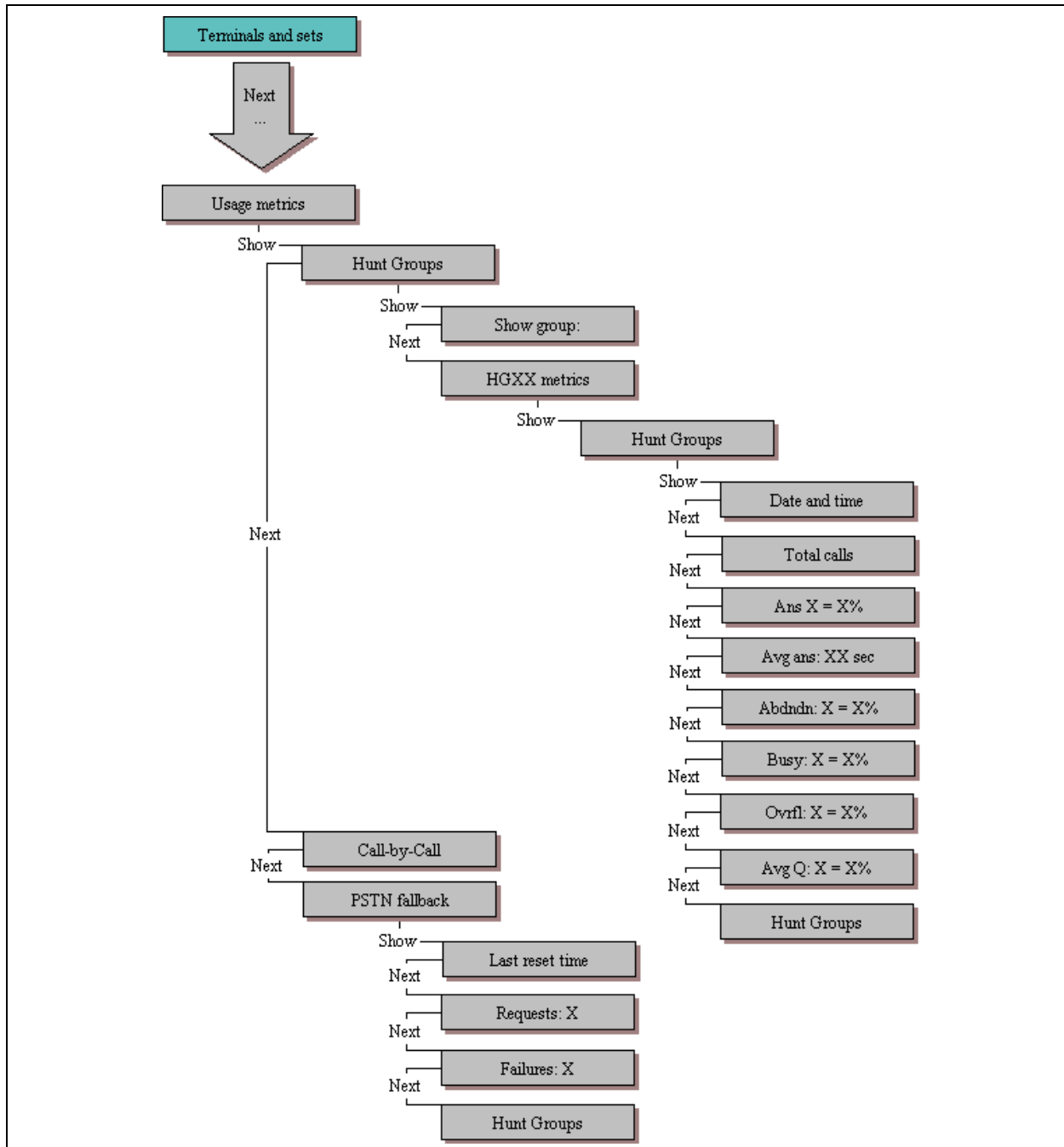
Figure 37 Maintenance (Sheet 2 of 2)



Usage metrics

Figure 38 shows the headings under the telset interface **Usage Metrics** heading. These records are used to display performance records.

Figure 38 Usage Metrics



Index

Numerics

7316E overlay 22

C

Conventions, guide 6

 button options 6

 buttons 6

 command line 6

copyright 2

D

Display 6

I

installer programming 19

O

overlay 21

P

personal programming 20

programming

 customizing your system 19

 installer programming 19

 personal programming 20

 programming indicator^a 23

 programming indicator^o 23

 programming overlay 21

R

regulatory information 2

related publications 8

S

Symbols 6

T

trademarks 2

U

user programming 20

