

Call Center Management Information System

CCMIS  
Release

5.2

# *CC MIS Maintenance & Admin*

---

Preliminary 297-2671-545.05.05



Maintenance Interface  
User's Guide

**NORTEL**  
NETWORKS™

## CC MIS Maintenance and Administration Guide

---

### Maintenance Interface

CC MIS Release 5.2

NTP: 297-2671-545.05.05

Status: Preliminary

Date: January 2002

---

### © 1991-2002 Nortel Networks Corporation

All rights reserved.

---

### NORTEL NETWORKS CONFIDENTIAL:

The information contained in this document is the property of Nortel Networks (formerly Northern Telecom, Inc.). Except as specifically authorized in writing by Nortel Networks, the holder of this document shall keep the information contained herein confidential and shall protect same in whole or in part from disclosure and dissemination to third parties and use same for evaluation, operation, and maintenance purposes only.

Information is subject to change without notice. Nortel Networks reserves the right to make changes in design or components as progress in engineering and manufacturing may warrant.

DMS and Meridian are trademarks of Nortel Networks. HP, HP RuggedWriter, and HP LaserJet are trademarks of Hewlett-Packard Corporation. GRAFSMAN is a trademark of Soft-tek International. Reflection 4+ is a trademark of Walker, Ritchie & Quinn, Inc. System V/88 and Veritas are trademarks of Motorola Corporation. Windows, Windows 95, and Windows NT are trademarks of the Microsoft Corporation. Other trademarks, product names, and servicemarks contained in this guide are property of their respective companies or owners.

### European Regulatory Compliance and CE Marking:

The equipment is CE marked, identifying compliance with the relevant EU Directives, 89/336/EEC for ElectroMagnetic Compatibility and 73/23/EEC for Safety.

This product is intended for deployment in a light industrial, non-domestic environment and complies with the relevant EMC standards, EN55022 (class A) and EN50082-1. Since this is class A equipment, in a domestic environment this equipment may cause radio interference in which case the user may be required to take adequate measures.

Printed in the United States of America.

---

# *Publication History*

---

## **January 2002**

Preliminary version for Testing Group and VO Sites Release 5.2.



---

# Contents

---

<b>About this Guide .....</b>	<b>intr-1</b>
Acronyms .....	intr-4
Terms .....	intr-5
Networked CC MIS .....	1-1
<b>Introduction .....</b>	<b>1-1</b>
Features Added in Release 4 .....	1-3
Features Added in Release 5.0 .....	1-6
Features Added in Release 5.1 .....	1-6
Features Added in Release 5.2 .....	1-6
SNMP feature .....	1-7
Operating System Configuration command .....	1-7
Required Database Information .....	1-8
Modes of Operation .....	1-8
Introduction to Release 5 .....	2-1
<b>Installing CC MIS Release 5 .....</b>	<b>2-1</b>
Installing Release 5 .....	2-2
Configurable Intervals .....	2-9

<b>Installing Release 5 on New System</b> .....	<b>2-10</b>
New system .....	2-10
<b>Upgrade 3.x to 5.x</b> .....	<b>2-11</b>
<b>Re-calculating data storage parameters</b> .....	<b>2-11</b>
<b>Database upgrades</b> .....	<b>2-11</b>
<b>Preparing supervisor interface to CC MIS</b> .....	<b>2-11</b>
<b>Introduction to maintenance interface</b> .....	<b>3-1</b>
<b>Maintenance and administration menus</b> .....	<b>3-1</b>
Selecting menu items .....	3-1
User interface screens .....	3-1
<b>Accessing maint functions</b> .....	<b>3-1</b>
Accessing pop-up menus .....	3-2
Paging through a screen or menu .....	3-2
Selecting a menu item .....	3-2
Control commands .....	3-2
The role of the input/output line .....	3-2
PF keys and commands .....	3-2
<b>Menu map</b> .....	<b>3-3</b>
<b>Effect of the CC MIS operating state on the menu system</b> .....	<b>3-3</b>
<b>Setting up a new CC MIS system (overview)</b> .....	<b>3-4</b>
<b>Logging in</b> .....	<b>3-5</b>
Constraints .....	3-5
Guidelines .....	3-6
<b>Accessing on-line help</b> .....	<b>3-7</b>
<b>Accessing help in menus</b> .....	<b>3-7</b>
Accessing the help in screens .....	3-8
<b>Changing your password</b> .....	<b>3-9</b>
Guidelines .....	3-9
<b>Logging out</b> .....	<b>3-11</b>
Guidelines .....	3-11
<b>Maintenance menus and screens</b> .....	<b>3-12</b>
Maintenance and administration main menu .....	3-12
Configuration menu .....	3-12
System upgrade utility menu .....	3-13
Backup and restore menu .....	3-13
Run state utilities menu .....	3-14
Diagnostics menu .....	3-14
<b>Introduction</b> .....	<b>4-1</b>
<b>Shut down CC MIS</b> .....	<b>4-1</b>
<b>Shutdown, Startup, and Power down</b> .....	<b>4-1</b>
<b>Start up CC MIS</b> .....	<b>4-2</b>
Start up/shut down partitions .....	4-2
Power down CC MIS .....	4-2
<b>Shut down CC MIS</b> .....	<b>4-2</b>
<b>Start up CC MIS</b> .....	<b>4-4</b>
<b>Power down CC MIS</b> .....	<b>4-5</b>
<b>Power up the CC MIS system</b> .....	<b>4-6</b>
<b>Power failures</b> .....	<b>4-7</b>
CC MIS was not running .....	4-7
CC MIS was running .....	4-7
<b>Introduction</b> .....	<b>5-1</b>

---

<b>Backing up and Restoring data</b> .....	<b>5-1</b>
<b>Using the DAT drive for backups</b> .....	<b>5-2</b>
Write-protecting your DAT .....	5-3
<b>Backing up customer data</b> .....	<b>5-4</b>
Automatic backups .....	5-5
Manual backups .....	5-5
Backup screen commands .....	5-6
Constraints .....	5-7
Guidelines .....	5-8
<b>Restoring customer data from tape</b> .....	<b>5-9</b>
Constraints .....	5-9
<b>Introduction</b> .....	<b>6-1</b>
<b>Configuring the CC MIS system</b> .....	<b>6-1</b>
<b>Accessing the Configuration main menu</b> .....	<b>6-2</b>
Guidelines .....	6-2
<b>System Configuration</b> .....	<b>6-3</b>
Guidelines .....	6-4
Field descriptions .....	6-4
<b>Port Allocation</b> .....	<b>6-6</b>
Constraints .....	6-6
Guidelines .....	6-7
<b>Switch link configuration</b> .....	<b>6-8</b>
Guidelines .....	6-8
Command menu options .....	6-9
Live link .....	6-9
Simulator link .....	6-10
<b>Terminal Server Configuration</b> .....	<b>6-11</b>
Guidelines .....	6-11
Adding a Terminal Server .....	6-12
Configuring a Terminal Server .....	6-12
Editing a field .....	6-13
<b>SNMP configuration</b> .....	<b>6-14</b>
Field descriptions .....	6-15
Guidelines .....	6-16
<b>System configuration reports</b> .....	<b>6-17</b>
<b>Introduction</b> .....	<b>7-1</b>
<b>Partitions (local)</b> .....	<b>7-1</b>
Operating modes .....	7-2
Requirements for a running state .....	7-3
Partition configuration commands .....	7-3
Partition configuration options .....	7-4
Adding a Partition .....	7-5
Guidelines .....	7-5
Deleting a Partition .....	7-6
<b>Partition options</b> .....	<b>7-7</b>
Guidelines .....	7-12
<b>Disk Allocation</b> .....	<b>7-13</b>
Guidelines .....	7-14
<b>Storage calculator</b> .....	<b>7-16</b>
Guidelines .....	7-16

<b>Changing data storage parameters</b> .....	<b>7-17</b>
Guidelines .....	7-17
<b>Interval Configuration</b> .....	<b>7-18</b>
Issues Concerning Interval Lengths .....	7-18
<b>Connection parameters</b> .....	<b>7-19</b>
Guidelines .....	7-20
<b>Serial Terminals</b> .....	<b>7-21</b>
Add, Delete, or Change .....	7-21
Guidelines .....	7-22
<b>Printers</b> .....	<b>7-23</b>
Constraints .....	7-23
Guidelines .....	7-24
<b>Changing a printer definition</b> .....	<b>7-25</b>
Guidelines .....	7-25
<b>Removing a printer from the system</b> .....	<b>7-26</b>
Guidelines .....	7-26
<b>Wallboards</b> .....	<b>7-27</b>
Constraints .....	7-27
Guidelines .....	7-28
Changing a wallboard's configuration .....	7-28
Removing a wallboard from the system .....	7-28
<b>LAN Terminals</b> .....	<b>7-29</b>
Adding LAN Terminals .....	7-30
Deleting LAN Terminals .....	7-30
<b>Supervisor Privileges</b> .....	<b>7-31</b>
Guidelines .....	7-31
Display privileges .....	7-32
Report privileges .....	7-32
Configuration control privileges .....	7-33
Supervisor privileges .....	7-34
Administration privileges .....	7-34
Data Access Priviledges .....	7-35
Supervisor override privileges .....	7-35
<b>Partition Startup/Shutdown</b> .....	<b>7-37</b>
Guidelines .....	7-38
<b>Configuring a PC to receive data export files</b> .....	<b>7-39</b>
<b>Introduction to Networked CC MIS</b> .....	<b>8-1</b>
<b>Networked CC MIS</b> .....	<b>8-1</b>
<b>Overview of a Network</b> .....	<b>8-2</b>
<b>Views in the Network</b> .....	<b>8-2</b>
<b>Steps for Establishing a Network</b> .....	<b>8-3</b>
<b>System Configuration</b> .....	<b>8-4</b>
Guidelines .....	8-5
Field descriptions .....	8-5
<b>Physical Network Configuration</b> .....	<b>8-7</b>
<b>Adding a node to the physical network</b> .....	<b>8-9</b>
<b>Deleting a node from the physical network</b> .....	<b>8-10</b>
<b>Switch Link Configuration</b> .....	<b>8-11</b>
<b>Partition Configuration</b> .....	<b>8-11</b>
Guidelines .....	8-15
Deleting a Partition .....	8-16
Partition configuration options .....	8-17



<b>Disk Allocation</b> .....	<b>8-18</b>
<b>Virtual Network Configuration</b> .....	<b>8-19</b>
Partition options .....	8-22
Guidelines .....	8-25
<b>Introduction</b> .....	<b>9-1</b>
<b>Monitoring system functions</b> .....	<b>9-1</b>
Accessing the diagnostics menu .....	9-2
<b>Displaying free disk space</b> .....	<b>9-3</b>
<b>File transfer</b> .....	<b>9-4</b>
<b>Testing the input/output ports</b> .....	<b>9-6</b>
<b>Test individual I/O ports</b> .....	<b>9-7</b>
<b>Logs</b> .....	<b>9-8</b>
Viewing a log .....	9-10
Monitoring a log .....	9-11
Printing a log .....	9-12
Cancelling the log printout .....	9-12
<b>View system monitor</b> .....	<b>9-13</b>
Program status .....	9-13
Lock status .....	9-17
Partition status .....	9-19
Port status .....	9-21
CPU utilization status .....	9-23
Additional System Monitor Screens .....	9-25
Physical Node Status .....	9-25
Virtual Node Status .....	9-25
Resetting the modem port .....	9-26
<b>Link trace</b> .....	<b>9-27</b>
Starting / Stopping the link trace .....	9-30
Viewing the link trace .....	9-30
Viewing the translated link trace .....	9-31
Using the Search function .....	9-31
Search Instructions .....	9-32
Printing the link trace .....	9-33
Printing the translated link trace .....	9-33
Cancelling link trace printing .....	9-34
Select different link .....	9-34
<b>TCP / IP Switch Link Diagnostics</b> .....	<b>9-36</b>
Checking a switch link .....	9-36
<b>X.25 Diagnostics</b> .....	<b>9-37</b>
Checking an X.25 link .....	9-37
Disabling an X.25 link .....	9-38
Enabling an X.25 link .....	9-38
Cancel X.25 link check .....	9-39
Initializing an X.25 link .....	9-39
<b>Physical Network Login</b> .....	<b>9-40</b>
<b>Introduction</b> .....	<b>10-1</b>
<b>Configuration Updates</b> .....	<b>10-1</b>
<b>Introduction</b> .....	<b>11-1</b>
<b>CC MIS software upgrades</b> .....	<b>11-1</b>

Software upgrades .....	11-2
<b>Load new software version .....</b>	<b>11-2</b>
.....	11-5
<b>Installing a New Keycode on CC MIS 5.0 System .....</b>	<b>11-6</b>
<b>Introduction .....</b>	<b>12-1</b>
<b>SNMP transfer .....</b>	<b>12-1</b>
Guidelines .....	12-2
<b>Changing OS configuration .....</b>	<b>13-1</b>
<b>Operating System Config .....</b>	<b>13-1</b>
Adding a Unix printer .....	13-2
Deleting a Unix printer .....	13-4
Adding disk(s) command .....	13-4
Changing Time Zone settings .....	13-5
Making direct changes to the OS configuration .....	13-6
Getting help .....	13-7
<b>Preventive maintenance .....</b>	<b>14-1</b>
Check filter .....	14-1
<b>Preventive maintenance .....</b>	<b>14-1</b>
Tape rotation .....	14-2
DAT head cleaning .....	14-2
<b>Technical specifications .....</b>	<b>A-1</b>
Real-time performance .....	A-1
Reliability .....	A-1
Consistent configuration data .....	A-1
Automatic backup .....	A-2
Power failure .....	A-2
Personal computer support .....	A-2
<b>System Log Messages .....</b>	<b>B-1</b>
<b>Installing the operating system .....</b>	<b>C-1</b>
<b>Historical database .....</b>	<b>D-1</b>
Historical database equations .....	D-4
Introduction .....	E-1
<b>System Configuration Reports .....</b>	<b>E-1</b>
System configuration report .....	E-3
Port allocation report .....	E-4
Switch link configuration report .....	E-5
Partition configuration report .....	E-6
Disk allocation report .....	E-7
Connection parameters report .....	E-8
Partition options report .....	E-9
Terminal server report .....	E-10
StaticLAN terminal report .....	E-11
Serial terminal report .....	E-12

---

<b>Printer configuration report .....</b>	<b>E-13</b>
<b>Wallboard configuration report .....</b>	<b>E-14</b>
<b>Storage parameters report .....</b>	<b>E-15</b>
<b>Interval Configuration Report .....</b>	<b>E-16</b>
<b>Simulator configuration report .....</b>	<b>E-17</b>
<b>SNMP configuration report .....</b>	<b>E-18</b>
<b>Physical network configuration report .....</b>	<b>E-19</b>
<b>Virtual network configuration report .....</b>	<b>E-20</b>
<b>Master privilege Override report .....</b>	<b>E-21</b>
<b>Master privilege definition report .....</b>	<b>E-22</b>



---

# Figures

---

Figure 3.1	Maintenance and Administration menus	3-3
Figure 3.2	Maintenance main menu (CC MIS operating)	3-5
Figure 3.3	Maintenance and Administration menu	3-12
Figure 3.4	Configuration menu	3-12
Figure 3.5	System upgrade utility menu	3-13
Figure 3.6	Backup and restore menu	3-13
Figure 3.7	Run state utilities menu	3-14
Figure 3.8	Diagnostics menu	3-14
Figure 4.1	Run state utilities menu	4-1
Figure 5.1	Backup and restore menu	5-1
Figure 5.2	DAT drive unit	5-2
Figure 5.3	Digital audio tape	5-3
Figure 5.4	Backup screen	5-6
Figure 5.5	Restore screen	5-10
Figure 6.1	Configuration main menu	6-2
Figure 6.2	System configuration screen	6-3
Figure 6.3	Port Allocation screen	6-6
Figure 6.4	Switch link configuration screen - Initial	6-8

---

Figure 6.5	Switch link configuration screen - live link	6-9
Figure 6.6	Switch link configuration screen - Simulator link	6-10
Figure 6.7	Terminal Server screen	6-11
Figure 6.8	Adding a Terminal Server	6-12
Figure 6.9	Configuring a Terminal Server	6-12
Figure 6.10	Editing a field on the Terminal Server screen	6-13
Figure 6.11	SNMP configuration	6-14
Figure 7.1	Configuration menu	7-1
Figure 7.2	Partition Configuration screen	7-2
Figure 7.3	Partition options screen	7-7
Figure 7.4	Disk Allocation screen	7-13
Figure 7.5	Storage calculator screen	7-16
Figure 7.6	Interval Configuration screen	7-18
Figure 7.7	Connection Parameters screen	7-19
Figure 7.8	Serial terminals screen	7-21
Figure 7.9	Printer Configuration screen	7-23
Figure 7.10	Wallboard Configuration screen	7-27
Figure 7.11	LAN Terminals screen (with add text)	7-29
Figure 7.12	Master Privilege Definition screen	7-32
Figure 7.13	Display Privileges screen	7-32
Figure 7.14	Report Privileges screen	7-33
Figure 7.15	Configuration Control Privileges screen	7-33
Figure 7.16	Supervisor Privileges screen	7-34
Figure 7.17	Administration Privileges screen	7-34
Figure 7.18	Data Access Privilege screen	7-35
Figure 7.19	Supervisor Override screen	7-35
Figure 7.20	Maintenance and Administration menu	7-37
Figure 7.21	Run state utilities screen	7-37
Figure 7.22	Partition startup and shutdown screen	7-38
Figure 8.1	Network Overview	8-2
Figure 8.2	Configuration menu	8-3
Figure 8.3	System Configuration screens	8-4
Figure 8.4	Physical Network Configuration screen	8-7
Figure 8.5	Add Node menu	8-9
Figure 8.6	Add Node Commands menu	8-9
Figure 8.7	Delete Node menu	8-10
Figure 8.8	Partition Configuration screen	8-11
Figure 8.9	Add Partition options menu	8-13
Figure 8.10	Add Partition and Commands menus	8-14
Figure 8.11	Configuration Options menu	8-17
Figure 8.12	Virtual Network Configuration screen	8-19
Figure 8.13	Add Partition to Network screen	8-20
Figure 8.14	Delete Partition from Network screen	8-21
Figure 8.15	Delete Partition from Network confirmation screen	8-21
Figure 8.16	Partition options screen	8-22
Figure 9.1	Diagnostics menu (when software is running)	9-1

---

Figure 9.2	Display Free Disk Space screen	9-3
Figure 9.3	File Transfer screen	9-4
Figure 9.4	Test individual I/O screen	9-7
Figure 9.5	CC MIS system logs screen	9-8
Figure 9.6	Program Status screen with Commands menu	9-13
Figure 9.7	Lock Status screen	9-17
Figure 9.8	Partition Status screen	9-19
Figure 9.9	Port Status screen	9-21
Figure 9.10	CPU Utilization Status screen	9-23
Figure 9.11	Physical Node Status screen	9-25
Figure 9.12	Virtual Node Status screen	9-25
Figure 9.13	Link Trace screen (multiple links)	9-27
Figure 9.14	CC MIS Link Trace menu screen	9-28
Figure 9.15	CC MIS Message Translator Filter screen	9-28
Figure 9.16	Untranslated Link Trace file example	9-29
Figure 9.17	Translated Link Trace file example	9-29
Figure 9.18	Search function key	9-31
Figure 9.19	Search screen	9-32
Figure 9.20	Search options pop-up	9-32
Figure 9.21	TCP / IP Switch Link Diagnostics	9-36
Figure 9.22	CC MIS X.25 Diagnostics screen (with Commands menu)	9-37
Figure 9.23	Physical Network Login screen	9-40
Figure 0.1	Run State Utilities menu	10-1
Figure 0.2	Configuration update prompt screen (multiple links)	10-2
Figure 0.3	Configuration update prompt screen (single link)	10-3
Figure 11.1	System Upgrade Utilities menu	11-1
Figure 11.2	Install License Keycode	11-6
Figure 11.3	System Serial Number	11-6
Figure 11.4	Entering Keycode	11-7
Figure 11.5	Confirm Settings	11-7
Figure 11.6	Continue Keycodes	11-8
Figure 12.2	Sample SNMP transfer session	12-2
Figure 3.2	OS Configuration menu	13-2
Figure 3.3	Adding a Unix printer	13-2
Figure 3.4	Specifying the name	13-3
Figure 3.5	Adding the printer	13-3
Figure 3.6	Delete printer screen	13-4
Figure 3.7	Adding disk(s)	13-4
Figure 3.8	Time Zone	13-5
Figure 3.9	Direct OS Configuration	13-6
Figure 3.10	Help screen	13-7
Figure 4.1	Location of filter	14-2
Figure 4.2	DAT drive unit	14-3
Figure E.1	Configuration menu	E-1
Figure E.2	System configuration report	E-3
Figure E.3	Port allocation report	E-4

---

Figure E.4	Switch link configuration report	E-5
Figure E.5	Partition configuration report	E-6
Figure E.6	Disk allocation report	E-7
Figure E.7	Connection parameters report	E-8
Figure E.8	Partition options report	E-9
Figure E.9	Terminal server report	E-10
Figure E.10	Static LAN terminals report	E-11
Figure E.11	Serial terminal report	E-12
Figure E.12	Printer configuration report	E-13
Figure E.13	Wallboard configuration report	E-14
Figure E.14	Storage Parameters report	E-15
Figure E.15	Interval configuration report	E-16
Figure E.16	Simulator configuration report	E-17
Figure E.17	SNMP configuration report	E-18
Figure E.18	Physical network configuration report	E-19
Figure E.19	Virtual network configuration report	E-20
Figure E.20	Master Privilege Override report	E-21
Figure E.21	Master Privilege Definition report	E-22



---

# Tables

---

Table 1:	Typographical conventions	intr-2
Table 2:	Conventions used in procedures	intr-3
Table 2-1:	Data storage parameters	2-3
Table 3-1:	Functions requiring CC MIS to be shut down	3-4
Table 5-1:	Backup screen commands	5-7
Table 6-1:	System configuration field descriptions	6-4
Table 6-2:	SNMP field descriptions	6-15
Table 7-1:	Partition configuration function commands	7-3
Table 7-2:	Partition configuration options	7-4
Table 7-3:	Partition options screen fields	7-8
Table 7-4:	Disk allocation screen parameters	7-14
Table 7-5:	Connection parameter screen fields	7-19
Table 7-6:	Supervisor Override field descriptions	7-36
Table 8-1:	System configuration field descriptions	8-5
Table 8-2:	Physical Network screen definitions	8-8
Table 8-3:	Physical Network Function keys	8-8
Table 8-4:	Add Node commands	8-10
Table 8-5:	Function key commands	8-12

---

Table 8-6:	Add Partition commands menu	8-14
Table 8-7:	Partition configuration options	8-18
Table 8-8:	Virtual Network Configuration field descriptions	8-19
Table 8-9:	Virtual Network Configuration function keys	8-20
Table 8-10:	Partition options screen fields	8-23
Table 9-1:	Logs screen fields	9-9
Table 9-2:	Program status screen fields	9-14
Table 9-3:	Lock status screen fields	9-17
Table 9-4:	Partition status screen fields	9-19
Table 9-5:	Port status screen fields	9-21
Table 9-6:	CPU Utilization status fields	9-23
Table D-1:	Historical database tables	D-1
Table D-2:	Historical database values	D-2

---

# *Steps*

---

- Step 2-1: Installing Release 5 on a new system 2-10
- Step 2-2: Preparing PCs to display CC MIS 2-12
- Step 3-1: Logging into maint 3-6
- Step 3-2: Accessing on-line help in maintenance menus 3-7
- Step 3-3: Accessing on-line help in user interface screens 3-8
- Step 3-4: Changing the maint password 3-9
- Step 3-5: Logging out of maint 3-11
- Step 4-1: Shutting down CC MIS 4-3
- Step 4-2: Starting CC MIS 4-4
- Step 4-3: Power down CC MIS 4-5
- Step 4-4: Powering up CC MIS 4-6
- Step 4-5: Recovering from a power failure 4-7
- Step 5-1: Accessing the backup and restore menu 5-2
- Step 5-2: Inserting a DAT tape into the tape drive 5-4
- Step 5-3: Ejecting a DAT tape from the tape drive 5-4
- Step 5-4: Backing up customer data 5-8
- Step 5-5: Restoring customer data 5-11
- Step 6-1: Accessing the Configuration menu 6-2
- Step 6-2: Accessing the System Configuration screen 6-4
- Step 6-3: Accessing the Port Allocation screen 6-7

- 
- Step 6-4: Accessing the Switch Link Configuration screen 6-8
  - Step 6-5: Accessing the Terminal Server screen 6-11
  - Step 6-6: Accessing the SNMP Configuration screen 6-16
  - Step 7-1: Adding a partition 7-5
  - Step 7-2: Deleting a partition 7-6
  - Step 7-3: Accessing the Partition Options screen 7-12
  - Step 7-4: Assigning a disk 7-14
  - Step 7-5: Reviewing database parameters 7-16
  - Step 7-6: Changing data storage parameters 7-17
  - Step 7-7: Accessing the Connection Parameters screen 7-20
  - Step 7-8: Adding a serial terminal 7-22
  - Step 7-9: Adding a printer 7-24
  - Step 7-10: Changing a printer definition 7-25
  - Step 7-11: Removing a printer definition 7-26
  - Step 7-12: Adding a wallboard 7-28
  - Step 7-13: Accessing LAN terminals 7-29
  - Step 7-14: Adding LAN terminals 7-30
  - Step 7-15: Deleting LAN terminals 7-30
  - Step 7-16: Accessing the Master Privilege screen 7-31
  - Step 7-17: Accessing Partition Startup and Shutdown screen 7-38
  - Step 7-18: Setting up a PC to receive data export files 7-39
  - Step 8-1: Accessing the System Configuration screen 8-5
  - Step 8-2: Adding a NAP 8-15
  - Step 8-3: Deleting a partition 8-16
  - Step 8-4: Accessing the Partition Options screen 8-25
  - Step 9-1: Accessing the Diagnostic menu 9-2
  - Step 9-2: Displaying free disk space 9-3
  - Step 9-3: Performing a file transfer 9-5
  - Step 9-4: Testing all ports 9-6
  - Step 9-5: Testing an individual port 9-7
  - Step 9-6: Selecting a log 9-9
  - Step 9-7: Viewing a log 9-10
  - Step 9-8: Monitoring a log 9-11
  - Step 9-9: Printing a log 9-12
  - Step 9-10: Cancelling a log printout 9-12
  - Step 9-11: Accessing the View System Monitor screen 9-14
  - Step 9-12: Resetting a modem port 9-26
  - Step 9-13: Starting/stopping link trace 9-30
  - Step 9-14: Starting/stopping link trace 9-30
  - Step 9-15: Viewing a translated link trace file 9-31
  - Step 9-16: Printing a link trace file 9-33
  - Step 9-17: Printing a translated link trace file 9-34
  - Step 9-18: Cancelling link trace printing 9-34
  - Step 9-19: Selecting a different link for link trace 9-35
  - Step 9-20: Checking a TCP / IP link 9-36
  - Step 9-21: Checking an X.25 link 9-37
  - Step 9-22: Disabling an X.25 link 9-38
  - Step 9-23: Enabling an X.25 link 9-38
  - Step 9-24: Cancelling an X.25 link check 9-39
  - Step 9-25: Physical network login screen 9-40
  - Step 10-1: Accessing the configuration update screen 10-2
  - Step 10-2: Running a configuration update 10-3
  - Step 11-1: Load new CC MIS software version 11-3
  - Step 12-1: Accessing SNMP transfer screen 12-2

Procedure C-1: Installing the SVR4 OS C-1  
Procedure C-2: Installing the AIX OS C-6  
C-8



## About this Guide

---

This document is an operations guideline for the systems maintenance engineer of a Call Center Management Information System (CC MIS) linked to an MSL-100 (Meridian 1 Options 111-211), DMS-500, or a DMS-100 supporting the 32 or 35 protocol version and ACD-MIS Interface Specification, Version 6 and 9.



The switch supporting CC MIS, the MSL-100 or the DMS-100, is called a DMS-ACD throughout this book.



It is recommended that your switch be at BCS35 when the Networking feature is enabled for your CC MIS system.

### *Related documents*

The following Nortel Networks Publications (NTP) contain additional information to supplement this document:

ACD MIS Interface Specifications, Version 9 (NT MIS-Q209-2)

DMS-100 Common Customer Data Schema (NTP 297-1001-451)

MDC Customer Data Schema (NTP 297-2001-451)

Call Center MIS System Description (NTP 297-2671-150)

Meridian SL-100 ACD General Description (NTP 555-4101-100)

Meridian SL-100 ACD Load Management (NTP 555-4101-102)

Meridian SL-100 ACD Management Information Interface (NTP 555-4101-103)

Meridian SL-100 ACD Feature Operation and Testing (NTP 555-4101-300)

Meridian SL-100 ACD MMI and Feature Implementation (NTP 555-4101-310)

Meridian SL-100 Network ACD General Description (NTP 555-8101-100)

For more information on ACD, refer to the following Northern Telecom Publications (NTPs):

ACD Product Guide (NTP 297-2041-010)

ACD Server Product Guide (NTP 297-2041-011)

ACD Planning and Engineering Guide (NTP 297-2041-101)

ACD Planning and Engineering Guide - Canada (NTP 297-2041-104)

ACD Administration Guide (NTP 297-2041-301)

ACD Translations (NTP 297-2041-350)

ACD Maintenance Guide (NTP 297-2041-500)

ACD Trouble Locating and Clearing Procedures (NTP 297-2041-503)

M5212 ACD Set General Description (NTP 297-2041-900)

ACD End-User Load Management (NTP 297-2041-901)

Network ACD General Description (up to BCS 34) (NTP 555-8101-100)

The following typographic conventions are used throughout this user guide.

**Table 1: Typographical conventions**

Key Sequence	Function
<Return>	Words in angled brackets represent a specific key on your keyboard that you should press.
[Commands]	Words in square brackets represent one of the keys available to you from the function key menu.





The PF keys associated with a command are listed on the lower portion of the appropriate screen. Procedures in this guide provide the name of the function key. The screens in this guide show examples of PF keys with associated commands. The actual PF number is dependent on the type of terminal and emulation mode being used. Refer to the program screen for the actual function key to press to select the desired command.

The following typographic conventions are used in the procedural tables in this user guide.

**Table 2: Conventions used in procedures**

Key Sequence	Function
Enter <i>n</i>	Letters in italics represent the key that you press in the action part of the procedure. Enter means that you press <Return> after you press the key.
<i>Notice</i>	Words in italics represent a system response to the actions in the procedure.
<b>Did you</b>	Words in bold represent the text of a specific message on a screen.

## Acronyms

This document uses the following acronyms:

Acronym	Meaning
ACD	Automatic Call Distribution
CC MIS	Call Center MIS
DAT	Digital Audio Tape
DB	Database
LAN	Local Area Network
LOB	Line-of-Business
MAR	Message Arrival Rate
MIB	Management Information Base
MIS	Management Information System
MSR	Message Service Rate
NAP	Network Access Partition
NMS	Network Management System
NOS	Network Operation Services
PC	Personal Computer
SNMP	Simple Network Management Protocol

## Terms

This document uses the following terms:

direct connect printer	A printer that is physically connected to the host machine.
local partition	A partition that provides access to local data only.
NAP	Network Access Partition. A partition that provides access to other partitions in the network. NAPs can only exist on a network node.
network node	A physical node that has Networked CC MIS capabilities.
Network	A collection of nodes. The nodes may be the actual host systems or partitions depending on the type of network (physical or virtual).
PC-attached printers	Printers that are directly connected to a supervisor terminal.
physical network	A network of CC MIS systems. The IP addresses of the host systems are specified in the Physical Network screen.
physical node (node)	The physical host machine on which the CC MIS maintenance and administration software is installed. This node may also be referred to as the VME, host, node, PowerPC, VME 8420, or XR VME.
PowerPC platform	Denotes that the information provided is applicable to nodes that are PowerPC-based running the AIX operating system.
system	The host platform (computer) on which CC MIS is installed.
virtual node	A partition in a CC MIS virtual network. This is a local partition.
virtual network	A network comprised of local partitions that can be accessed by the NAP.
88K-based platform	Denotes that the information provided is applicable to nodes that are 187 or 197 processor-based systems (VME 8420 or XR VME).



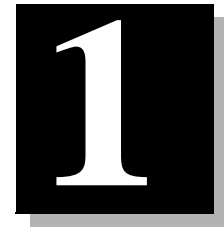

# Section 1: Introduction



 *Description of CC MIS*

 *Required database information*

 *Features of Software  
Release 5.0*

 *CC MIS modes of operation*

## *Description of CC MIS*

Call Center Management Information System (CC MIS) is a tool for managing the agents who handle ACD calls. It helps supervisors plan, manage, and monitor their ACD operation by collecting statistics on the performance of equipment and personnel.

### **Networked CC MIS**

The Networked CC MIS feature is available in Release 4. This feature must be purchased and enabled in customer options. When enabled, the Configuration menu in the Maintenance Interface contains commands for defining a CC MIS network. Refer to Section 8 in this guide for information on setting up CC MIS nodes for network access.

### **System Sizes**

CC MIS is available in different configurations: from 8 ports to 64 ports (128 on PowerPC).

### **Minimum upgrade requirements**

The minimum requirements for upgrade for an existing 88K platform from CC MIS Release 2.x to 5.x are as follows:

- at least 32 Mbyte RAM
- approximately 460 Mbytes space for Operating System and CC MIS software
- new version of UNIX Operating System, SVR4.3 (NTOS 2.x)

CC MIS consists of two types of interfaces: supervisor terminals and a maintenance console.

## **Supervisor terminals**

Supervisors manage their agents through menus accessed at a supervisor terminal. The terminal is a personal computer running Windows 95 or Windows NT 4.0 defined as a supervisor terminal linked to a Host system (VME 8420, XR VME or the PowerPC [AIX]). CC MIS Online Help contains procedures to assist supervisors in using CC MIS.

## **Maintenance console**

Engineers maintain CC MIS through the maintenance console. The console used must have VT220 emulation capability. Through this console, engineers can perform the following functions:

- diagnostics
- adjust CC MIS configuration and logon parameters to the switch
- add and delete partitions
- view and print logs
- routine backup, restore, and software upgrade functions for the CC MIS system
- establish and modify CC MIS network parameters

The maintenance console is a system console attached to the host. Maintenance functions are menu driven and are accessible only on the maintenance console or by maintenance dial-up. This document contains procedures to assist system engineers in maintaining the CC MIS system.

Supervisors can display information on wallboards. The wallboard is a Silent Radio Wall Display LED message board or Nortel wallboards. It is designed to be mounted on the wall of an ACD group office. Supervisors use the wallboard to notify agents of statistical and administrative information.

*Changes to the  
Maintenance Interface  
in Release 4.0*

## Features Added in Release 4

The following enhancements and changes were made to the Maintenance Interface in Software Release 4 and are present in Release 5.1.

General changes to the Maintenance Interface include:

- **Physical Node Status** - The Physical Node Status in View System Monitor has been added to assist the user in diagnosing CC MIS networking problems.
- **System Identification** - Maintenance menus now include the system name in the title, to ease identification of the system.
- **Login Support** - The new Physical Network Login screen provides access for logging into other nodes in the CC MIS physical network.
- **Backup and restore** - The Backup and Restore functions were modified to reflect the change in the name of the System Database to the Definitions Database.
- In Release 4.1, support was added for the PowerPC running the AIX operating system.

The changes made to Configuration section of Maintenance include:

- **Networked CC MIS Configuration** - Two new customer options were added to the install tape to indicate whether or not a physical node is a Network Node and the maximum number of Network Access Partitions (NAPs) that may be configured on the node.
- **Network Name** - This field was added to System Configuration for defining and securing the network.
- **New Configuration Commands** - The Configuration screen was updated to include the Physical Network Configuration command.
- **Physical Network Definition** - The nodes that comprise a CC MIS physical network are defined using the new Physical Network Configuration screen.
- **Switch Link Configuration** - The maximum number of X.25 links was increased to four (4). (The maximum is 12 for the PowerPC in Release 4.1.) The Connection to Switch parameter was added to the link definition to indicate whether a live link uses modems or direct connection to connect to the switch. This parameter does not apply to simulator links. New fields on this screen include: Sync with Switch and Time Zone Adjustment.

- **Network Access Partitions (NAP)** - The Partition Configuration supports Network Access Partition (NAP) configuration. The NAP must be defined on a network node. The number of NAPs allowed is controlled by the value entered in the Maximum NAPs field (when setting the tape options). NAPs are used to access local partitions in a CC MIS network.
- **Virtual Network Configuration** - The Virtual Network Configuration screen was added to define the nodes that comprise a virtual network associated with a NAP.
- **Master Privilege Definition** - Supervisor privileges may be restricted on a per partition basis using the new Master Privilege and supervisor Override screens and a master supervisor privilege definition.
- **Configurable Intervals** - The interval period for each hour of the day can be configured in the Interval Configuration screen which is accessed from the Storage Calculator screen. (On NAPs, the Interval screen is accessed from the Configuration Options menu.) Valid intervals are 5, 10, 15, 30, and 60 minutes. The value of zero ( 0 ) is entered to turn off data collection for that hour.
- **Configuration Reports** - Several configuration reports were added and existing ones updated to reflect the changes to the Configuration section. The new or modified reports include:
  - New:*
    - Master Privilege Definition
    - Master Privilege Override
    - Virtual Network Configuration
    - Physical Network Configuration
    - Interval Configuration
    - Terminal Server Configuration
  - Modified:*
    - Partition Options
    - Partition Configuration
    - Port Allocation
    - System Configuration
    - Switch Link configuration
    - Storage Calculator
    - LAN Clients changed to LAN Terminals
    - Port Configuration changed to Serial Terminals, Wallboards, Printers



Summary of changes and enhancements were made to CC MIS in Release 4.1:

- Support for the PowerPC (AIX) platform was added.
- The Switch Code field was added to Switch Link Configuration to handle duplicate DNs that are datafilled on multiple switches in a private network when using the CC MIS Networking feature. (Added in Release 4.01.)
- Added support for PVC (Permanent Virtual Circuit) X.25 connections to the switch for increased link throughput. These changes allow CC MIS to connect to the switch by means of the new IOM-based high speed X.25 interface. (The following port parameters were added for X.25 links: Line Type, Clock, and Virtual Circuit Type. Enhanced the direct switch connection capability to allow a clock rate to be specified. Note that on the PowerPC, the DTE/DCE setup for a port is determined from the hardware and cannot be changed in the Switch Link Configuration screen as it can on the 88K platform. These changes provide enhanced support for direct X.25 connections to the switch and to new IOM-based high speed (512KBps) X.25 switch interface.)
- An Analyze Configuration function was added to the storage calculator. Pressing this function key allows the storage calculator to analyze the values for your system based on data received from the switch and your system configuration.

### Features Added in Release 5.0

The following enhancements and changes were made to the Maintenance Interface in Software Release 5.0.

- DHCP feature that allows LAN-based supervisor terminals to connect to CC MIS without their IP address being defined in the CC MIS Maintenance Interface. This feature is configured on the Partition Options screen.

IP addresses for static LAN terminals are still defined in the Static LAN Terminals screen. Terminology change on the Partition Configuration screen in the Maintenance Interface (LAN Terminals changed to Static LAN Terminals). This change is in conjunction with the DHCP feature.

- Two additional fields were added to the Storage Calculator (Agent Trace Data and Disk Space for Agent Trace) in the CC MIS Maintenance Interface.
- The Key Code feature was added to allow customer software to be upgraded remotely using a key code.

### Features Added in Release 5.1

The following enhancements and changes were made to the Maintenance Interface in Software Release 5.1.

- A TCP/IP switch link connection was added for LAN connection from the switch to CC MIS. This change is implemented in the Switch Link Configuration screen.
- Expanded the Time Zone Management feature to allow multiple time zones per CC MIS node. Time zones are set using the Partition Options screen.

### Features Added in Release 5.2

The following enhancements and changes were made to the Maintenance Interface in Software Release 5.2.

- Support for the new data access options from Privilege Level definition required corresponding changes to Master Privilege Definition so that these options could be enable/disabled on a partition-wide basis.

## SNMP feature

The Simple Network Management Protocol (SNMP) feature was added to CC MIS in Maintenance Release 3.2. This feature was added to allow certain CC MIS systems to automate the monitoring of both the CC MIS system and the ACD call center operation.

The SNMP feature is configured by selecting SNMP Configuration from the Configuration main menu (Chapter 6). The SNMP Configuration screen allows you to set up three communities and to specify addresses of SNMP managers. The SNMP feature is enabled for a partition through the Partition Configuration menu by accessing the Partition Options screen for a selected partition (Chapter 7). The SNMP feature has a reporting option that allows you to print a system report for SNMP configuration (Appendix E). This is accessed through the Reports command on the Configuration main menu (Chapter 6).

The Transfer SNMP MIB Definitions command on the System Upgrade Utility menu (Chapter 11) transfers CC MIS system MIB and CC MIS Partition MIB definition files to selected Network Management Systems (NMS).



Due to the technical nature of the SNMP feature, a background in network management and the SNMP protocol is recommended for administrators and users of this feature.

## Operating System Configuration command

The main Maintenance and Administration menu contains the Operating System Configuration command that can be used on AIX platforms to configure the base operating system.



This command does not appear on the main menu for Motorola 88K-based platforms.

This command is explained in Section 13 of this guide.

## Required Database Information

The CC MIS database needs information from the DMS-ACD tables to setup

- the interface to the DMS-ACD
- the pools and subpools of the ACD

CC MIS must have the same definitions used by the DMS-ACD for

- new and existing pools and subpools
- X.25 links
- Network Operations Services protocol

You cannot change, add, or delete information in these ACD tables through CC MIS. The CC MIS X.25 and Network Operation Services (NOS) logon information must match the information in the DMS-ACD tables to establish a connection to the DMS-ACD.

These DMS-ACD tables include

- NCSAPPL
- ACDMISPL
- ACDMISSP
- NOPADDR
- NOPAPPLN

## ACD data link

In order for CC MIS to communicate with the DMS-ACD, the CC MIS must establish datalink connections with the DMS-ACD over which agent and call event messages can pass. An ACD datalink is associated with one and only one ACD pool.

## Modes of Operation

In Release 4, the data disks are divided into partitions, with each partition having its own database. Operation modes are separate for each partition and apply to local nodes. Partitions can operate in a training mode, precut mode, or product mode. When the CC MIS system is first installed, the partition is in a setup mode. Using multiple partitions allows one partition to run in training mode while another partition is in product mode.

**Training mode**

When a partition is in training mode, supervisors train on the product without affecting live calls. In training mode, there is no connection between the partition and the DMS-ACD, and only training data is collected and reported.

When a partition is in training mode, CC MIS interacts with the simulator to provide training data. The simulator uses call scenarios and configuration control typical to the ACD environment. During training, supervisors can adjust load management values and move position assignments through the configuration control capability of CC MIS. As a result, the simulator generates ACD switch responses identical to ACD processing in a live environment.

**Precut mode**

Precut mode allows system engineers to enter all administration data into the partition's new databases in preparation for transition to product mode. During precut mode the following information is established:

- custom report definitions, display definitions, and schedules
- ACD group names, agent names, and threshold values
- supervisor profiles
- printer and supervisor terminals
- link and pool parameters
- database storage parameters

**Product mode**

In product mode, CC MIS establishes a connection between the CC MIS and the DMS-ACD and begins collecting live data based on the configuration of its ACD groups and agents. The information it stores is based on the configuration database.



## Section 2: Installing CC MIS Release 5



*Introduction to Release 5*



*Upgrading from 3.x to 5.0*



*Data storage parameters*



*Preparing Windows-based PCs for CC MIS*



*Installing Release 5.0 on a new system*

*New OS for  
upgrades  
from 1.x or 2.x*

### Introduction to Release 5

If you are upgrading from 1.x or 2.x to 3.x then to CC MIS Release 5, the installation of a new version of the operating system is required. Upgrades from 3.x or 4.x to 5.1 do not require this OS installation and can be performed from the Load New Software Version command.

The installation of the new operating system will remove all pre-existing software and data. Therefore, an upgrade from Release 1.x or 2.x to Release 3.x will be performed from the UNIX prompt rather than the "Load New Software Version" command found in the Maintenance Interface. Instructions for installing the new OS are provided in Appendix C.

**Note:** ALL user data must be backed up before the operating system upgrade and then restored.



**CAUTION**

The initial installation of CC MIS Release 5.2 should be performed by installation engineers. CC MIS releases older than Release 3.1 cannot be converted to Release 5 until they have been converted to at least Release 3.1.

Upgrades from Release 3.1 (or later) to 5.x can be performed using the options in the System Upgrade Utility menu - see Chapter 11.



The minimum requirements for upgrade from CC MIS Release 2.x to 5.x are as follows: at least 32 Mbytes RAM, and 460 Mbyte additional disk space for the new version of the UNIX Operating System and CC MIS software, and the SVR4 (NTOS 2.x) version of UNIX Operating System.

## Installing Release 5

There are two types of CC MIS systems for Release 5: Networked and Stand-alone.

If you are installing CC MIS Release 5 software for the first time, the order is: perform installation (procedures for upgrades from 3.x to 5.x and new installations of 5.2 are in this chapter), configure system (Chapter 6), and establish partitions (Chapter 7). Networked CC MIS systems need to establish physical nodes and virtual nodes for network access partitions (NAPs) as described in Chapter 8. Procedures for upgrades from 4.x to 5.x are presented in Chapter 11.

### Preparing for installation

This procedure gathers the information needed to configure the historical database for each partition (excluding training partitions and network access (NAP) partitions). The table below defines the Data Storage Worksheet parameters and gives their limits.



These parameters are used solely for computing disk storage and do not affect the operation within CC MIS. The exception is the storage duration (time and date intervals) parameters which also affect when data is deleted from the disk.

### Automated Calculations

In Release 4.x, a new Analyze Configuration function key was added to the Storage Calculator screen. Pressing this function key allows the storage calculator to analyze the values for your system based on data received from the switch and your system configuration.



Table 2-1: Data storage parameters

Parameter	Defines
Number of ACD groups	<p>The average number of ACD groups that can be datafilled to the pool assigned to the CC MIS system.</p> <p>Limits: 1 - number of ACD groups configured in the partition options screen, inclusive.</p> <p>Note: The installation tape defines the maximum number of groups and positions supported at a particular installation based on purchased options. CC MIS does not allow these maximums to be exceeded.</p>
Avg source ACD-DNs/group	<p>Enter the average number of source supplementary DNs that may provide calls for each ACD group.</p> <p>Limits: 1 - 9999, inclusive.</p> <p>Note: This field specifies the average number of supplementary DNs that will provide calls for each ACD group in this partition. Supplementary DNs that can overflow to other ACD groups should be counted once for the ACD group in which they are configured, plus once more for each possible ACD group to which they can overflow.</p>
Avg active positions	<p>The average number of positions that may be active at any time.</p> <p>Limits: 1 - number of posns configured in the partition options screen, inclusive.</p> <p>Note: The installation tape defines the maximum number of groups and positions supported at a particular installation based on purchased options. CC MIS does not allow these maximums to be exceeded.</p>
Avg agents per day	<p>The average number of agents that log in to CC MIS each day.</p> <p>Limits: 1-9999, inclusive.</p>

**Table 2-1: Data storage parameters**

Parameter	Defines
Avg agent events/agent/ day	<p>The expected number of agent events that may occur per agent per day. An agent event is defined as a log in, log out, walk-away, or return from walkaway.</p> <p>Limits: 2 - 9999, inclusive.</p>
Average LOB code/group	<p>The expected number of line-of-business (LOB) codes that will be used by an ACD group within any 30-minute interval.</p> <p>Limits: 0-100, inclusive.</p>
Average walk codes/group	<p>The expected number of walkaway codes that will be used by an ACD group within any 30-minute interval.</p> <p>Limits: 0-100, inclusive.</p>

Table 2-1: Data storage parameters

Parameter	Defines
Avg source groups/ dest group	<p>The expected number of combinations of source ACD groups and destination ACD groups for which calls either overflow or are transferred.</p> <p>Limits: 1-9999, inclusive.</p> <p>If there is no overflow or transfer, set this value to 1. When there are no transfers and no overflow abilities except for enhanced overflow, each group can overflow to four groups and itself, a total of 5. In this case, set this value to 5. If it is known that each group does not overflow to all groups on the average, this value can be decreased. If there are transfer calls and other overflow mechanisms in addition to enhanced overflow, increase this number. Use a conservative number to avoid filling up the database.</p> <p>Note 1: This parameter is just a guide to the system to set the database storage to allow for the number of records determined by the factor. The system does not check that this guideline has been exceeded. If the system has not been engineered to match the actual requirements, the database storage could be exceeded.</p> <p>Note 2: This parameter is used strictly to determine the number of records in the INTERVAL overflow table. The system has a hard-coded factor of 60 percent to compute the number of records in the daily, weekly, and monthly tables. For example, if the inter-flow is set to five (and there are 21 groups), then 105 records are allocated for each interval overflow table. For the daily, weekly, and monthly tables, 105 multiplied by 1.6 (or 168) records are allocated. This is due to the fact that some source/destination combinations may not occur during an interval but may occur some time during a day. If the 60 percent value is low based on expected call patterns, the inter-flow parameter should be increased to cover this.</p>

**Table 2-1: Data storage parameters**

Parameter	Defines
Position moves per day	The expected number of agent position reassignments that may occur in a day. This value is expressed as a percentage of the number of active positions.  Limits: 0-100, inclusive.
ACD-DN reassigns per day	The expected number of supplementary DN reassignments that may occur in a day. This value is expressed as a percentage of the number of active SDNs.  Limits: 0-100, inclusive.
Disk Space for Agent Trace	The amount of disk space that is reserved for storing Agent Trace data.  Values: Specified in Mega Bytes (MB).
Walkaway Statistics	This parameter indicates whether or not Walkaway Statistics data will be stored. If "none" is chosen for this parameter, there will be no data stored in the Walkaway Statistics group and there will be no data to report on for any of the standard Walkaway by Group Reports. If "by agent" is selected, the statistics are gather for the agent, and if "by group" is selected, the data for the group is stored.  Values: None, By Agent, or By Group.
ACD-DN Statistics	This parameter indicates whether or not data will be stored by ACD-DN. If "none" is chosen for this parameter, there will no data stored in the ACD-DN Statistics group and there will be no data to report on for any of the Standard ACD-DN reports. If "by agent" is selected, the statistics are gather for the agent, and if "by group" is selected, the data for the group is stored.  Values: None, By Agent, or By Group.

**Note:** The By Agent selection requires a significantly larger amount of disk space than does By Group or None.

In some cases, especially for ACD-DN statistics, collecting data on a per agent basis can cause excessively large data files to be created by the system. The storage calculator will provide a warning when these conditions arise and provide suggestions to help reduce the amount of data collected.

Table 2-1: Data storage parameters

Parameter	Defines
LOB Statistics	<p>This parameter indicates whether or not LOB Statistics data will be stored. If "none" is chosen for this parameter, there will be no agent data stored in the LOB Statistics group and there will be no agent data to report on for any of the standard LOB by Agent Reports. The "By Agent" setting collects LOB statistics at the agent level. The "By Group" setting collects LOB statistics at the group level.</p> <p>Values: None, By Agent, or By Group.</p> <p>Note: If this is set to "By Group" LOB statistics will not be collected at the agent level of detail.</p>
Interval data stored for	<p>The number of days for which interval storage should be kept. Interval storage is historical data with a granularity of 30 minutes.</p> <p>Note: Keep in mind that shift reports are generated from interval data. If a supervisor requests a shift report requiring data that extends beyond the time interval data is stored, no data will be found for the report.</p> <p>Limits: 0-9999, inclusive.</p>
Daily data stored for	<p>The number of days for which daily storage should be kept. Daily storage is historical data with a granularity of 24 hours (midnight to midnight).</p> <p>Note: Keep in mind that period reports use daily data to complete the period statistics. If a supervisor requests a period report requiring data that extends beyond the time daily data is stored, no data will be found for the report.</p> <p>Limits: 0-9999, inclusive.</p>

**Table 2-1: Data storage parameters**

Parameter	Defines
Weekly data stored for	The number of weeks for which weekly storage should be kept. Weekly storage is historical data with a granularity of 7 days.  Limits: 0-9999, inclusive.
Monthly data stored for	The number of months for which monthly storage should be kept. Monthly storage is historical data with a granularity of one calendar month.  Limits: 0-9999, inclusive.
Agent event data stored for	The number of days for which agent log events should be kept. Agent log events are events such as agent login or logouts and are reported on the agent log reports.  Limits: 0-9999, inclusive.
Agent trace data stored for	The number of days for which agent trace log events should be kept. Agent trace log events are events reported on the agent trace event log reports.  Limits: 0-9999, inclusive.
Number of shifts	The number of agent shifts that occur in a 24-hour period.  Limits: 1-5, inclusive.
Operational days per week	The number of days (out of 7) in which there will be some group active in the partition pool being monitored by CC MIS.  Limits: 1-7, inclusive.
Operational hours per day  (Not used if Flexible Intervals are enabled)	The number of hours (out of 24) in which there will be some group active in the partition pool being monitored by CC MIS.  Limits: 1-24, inclusive.

### Configurable Intervals

The Interval Configuration screen is displayed by selecting the Interval Configuration function key on the Storage Calculator screen. (For NAPs, the Interval Configuration option is selected from the Configuration Options menu.)

The amount of disk space available and the amount required to store data for the selected intervals is displayed on the screen. The storage calculator initially sets the amount of space required based on the default setting (30 minutes) for intervals.

**Note:** If you intend to use more frequent intervals (5, 10, or 15 minutes), additional disk space will be required.

For additional information concerning Interval Configuration, refer to Chapter 7 in this guide.

*Installing  
Release 5.x  
on a new  
system*

## Installing Release 5 on New System

Use this procedure to install CC MIS Release 5.x on a new system on the VME.

It is highly recommended that the initial installation of CC MIS Release 5 be performed by installation engineers.

Installation procedures use a DAT tape (described in Chapter 5).

### New system

Perform the steps in the procedure below to install CC MIS Release 5.x on a new system.

## Step 2-1: Installing Release 5 on a new system

1. Ensure that the system is down.
2. Install the SVR4 operating system (187 or 197 platforms) or the AIX operating system (PowerPC platform). (See Appendix C for information on loading the operating system.)
3. Login as root and enter root password.
4. Load the CC MIS Release 5.x.

```
type: cd /mis
type: pwd (verify that the current directory is /mis)
```

Then depending on the system (187, 197, or PowerPC) type:

```
cpio -iBcdmu < /dev/rmt/m187_c0d5 (MVME187 / DATs)
-or-
cpio -iBcdmu < /dev/rmt/m197_c0d5 (MVME197 / DATs)
-or-
tar xp (PowerPC platform)
```

5. Run the install script.

```
type: cd /mis/install
type: pwd (verify that the current directory is /mis/install)
type: ./install
```

A series of prompts are displayed during the installation process. The system messages displayed include prompts for the following:

```
maint password
date and time
Do you want to start the system now?
```

6. Type exit, then refer to Step 3-1 for logging on the Maintenance interface.



## Upgrade 3.x to 5.x

Refer to Chapter 11 for information on upgrading from Release 3.1 (or later) to 5.x. (You must be running at least Release 3.1 to upgrade to 4.1.)

### Re-calculating data storage parameters

After conversion from 3.x to 5.x is complete, you must access the Configuration menu in maintenance. Then, under the Partition Configuration option, examine and save the data storage parameters. This is necessary to ensure that the space allocated is correctly calculated for the new Release 5.x configuration. After the parameters are saved, you can start the partition. Refer to Chapter 7 for information on data storage and starting partitions.

### Database upgrades

The upgrade script upgrades all three databases to a Release 5.x level.

The upgrade script upgrades the configuration database (such as terminals, printers, and links) and the customer's definitions database (such as formula definitions, report definitions, and supervisor definitions).

## Preparing supervisor interface to CC MIS

After the CC MIS host has Release 5.x installed, the supervisor PCs can be upgraded using the procedures in this section.

This procedure prepares PCs to display the supervisor interface to CC MIS. The standard (English) version of Microsoft Windows NT 4.0 or Windows 95 software must have already been installed prior to performing this procedure.



The term "Windows" used throughout this guide refers to a version of Microsoft Windows and is a trademark of the Microsoft Corporation.

Perform the steps in the procedure below to prepare PCs to display the supervisor interface to CC MIS.

## Step 2-2: Preparing PCs to display CC MIS

### Materials required

CC MIS supervisor interface installation floppy.

**Note:** The PC must be running Windows 95, 98, 2000 or Windows NT.

### Installing on PCs with CC MIS Release 3.2 or greater

No installation from diskette is required when installing 5.x on a PC already running 3.2 or greater.

To upgrade to 5.x on the PC, simply start your current version of CC MIS, and the system will prompt you to upgrade your PC version to Release 5.x

This automated upgrade is performed after the Host has been upgraded.



Only installation engineers, not supervisors or system administrators, should perform this procedure.

1. Ensure that the Microsoft Windows software has been installed. Without Windows, this procedure cannot be completed.
2. At the PC (n Windows), access the Start menu and select the Run command.
3. Put the CC MIS Windows PC supervisor interface software distribution diskette in the floppy disk drive.
4. Use the following sequence to access the run command window:

At the command box, enter <drive>:setup. where <drive> is the drive letter of the drive containing the CC MIS Windows floppy. The install initialization window appears during initialization. After the initialization is complete, the welcome window appears.
5. Click on the Continue button. The install window appears.
6. Verify that the information in the Install To box is correct (the default location is c:\wccmis). If it is correct, skip to step 9.
7. Click on the Set Location button. The installation location window appears.
8. Enter the correct location and click on the OK button.
9. In the install window, click on the install button. The Windows supervisor interface to CC MIS is installed. After installation is completed, the installation complete window appears.
10. Click on the Launch CC MIS field to start CC MIS.
11. The CC MIS Main window is displayed. To verify the CC MIS version, select the Session/About CC MIS... option. Verify the version number in the dialog box, then click on the OK button to close the dialog.

## Section 3: Accessing maint functions

---



*Introduction to maintenance interface*



*Accessing on-line help in maintenance menus*



*Setting up a new CC MIS system (overview)*



*Changing your maintenance password*



*Logging into CC MIS maintenance interface*



*Maintenance menus and screens*

---

### **Introduction to maintenance interface**

The maintenance console allows you to access the maintenance functions of the CC MIS system. It also permits dial-up access to maintenance functions.

This chapter contains the following information and procedures:

- CC MIS Maintenance and Administration menus
- logging into and out of CC MIS Maintenance and Administration
- accessing the online help
- changing the maintenance password

#### **Maintenance and administration menus**

Maintenance and administration functions are available through a series of menus and user interface screens. Figure 3.1 shows how the menus branch.

#### **Selecting menu items**

You select items from a menu by typing the letter associated with the selection and pressing the <Enter> key.

#### **User interface screens**

User interface screens are different from the regular maintenance menu as they employ the same interface as the text supervisor interface from previous CC MIS releases. Selections on these screens are made using the function keys, arrow keys, and page up/down keys.

### Accessing pop-up menus

The various screens have pop-up menus associated with them. The pop-up menus list options available to you. Access a pop-up menu by pressing its associated function key listed at the bottom of the menu. Function keys, sometimes called soft keys, operate as toggles. The key that selects the function is the same key that deselects that function.

### Paging through a screen or menu

In some instances, a menu may have many options from which you select. Use the following commands to move to the top or bottom of the menu or screen:

- 0-PgUp (or Up arrow) - to page to the top of the menu
- 0-PgDn (or Down arrow) - to page to the bottom of the menu

### Selecting a menu item

To select a menu item in the Text interface, you may highlight the option using the up/down arrow keys. Or, you may type the number of the option and press the <Enter> key.

### Control commands

There are several control commands you can use at terminals using the Text interface. These commands are:

- Ctrl-R - redraws a screen (only in full-screen modes)
- Ctrl-T - allows you to select a new terminal type (only in full-screen modes and applies to either text interface)

### The role of the input/output line

The input/output line at the bottom of the screen displays error messages and anything typed. You can easily correct typing mistakes on the input/output line by using the <Backspace> and other keys just as you would while typing. Your input is not accepted by the system until you press <Enter>.

### PF keys and commands

The PF keys associated with a command are listed on the lower portion of the appropriate screen. Procedures in this guide provide the name of the function key. The screens in this guide show examples of PF keys with associated commands. The actual PF number is dependent on the type of terminal and emulation mode being used. Refer to the program screen for the actual function key to press to select the desired command.

### Menu map

The figure below shows the overall structure of the menus and screens found in the Maintenance Interface. The actual menu commands displayed on your system are dependent on which features are enabled.

Figure 3.1 Maintenance and Administration menus

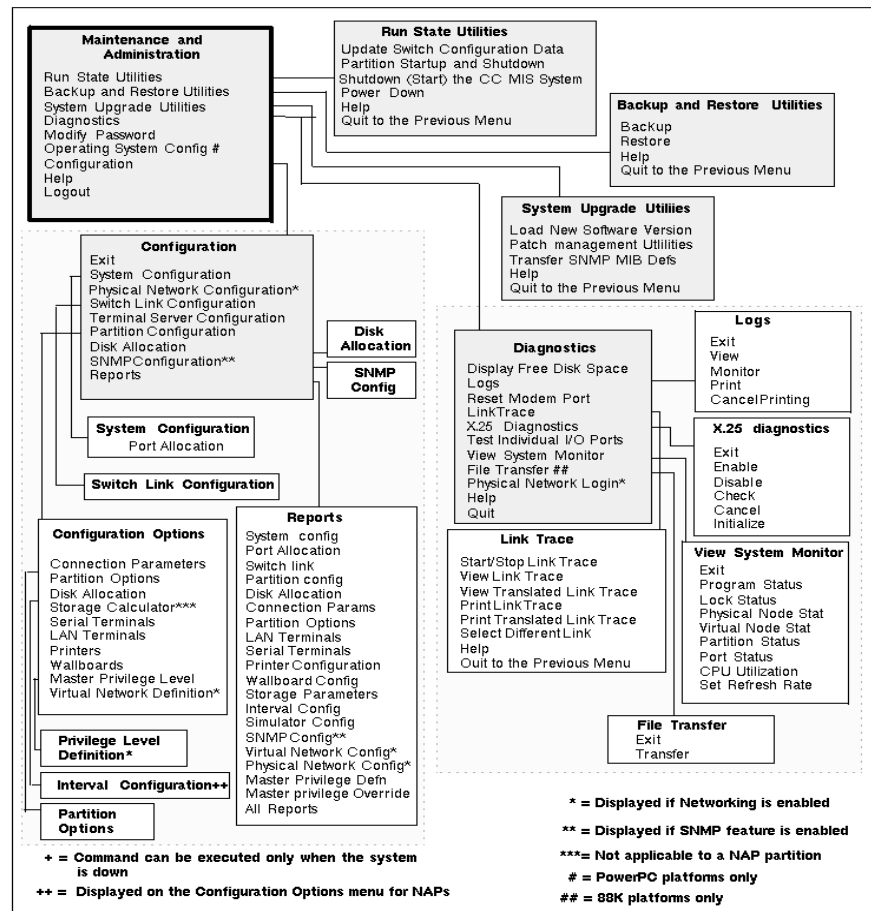

### Effect of the CC MIS operating state on the menu system

While the majority of the functions are available at all times, some functions can be performed only when CC MIS is shut down, while other functions can be performed only when CC MIS is operating.

Partitions can be running or stopped. Stopping one partition does not affect the running status of other partitions.

CC MIS can be running or shut down. For the most part, shutdown of CC MIS is automatic. When you request such a function, the software requires you to confirm CC MIS shutdown. The confirmation gives you control over the state of CC MIS. Table 3-1 identifies the functions that require CC MIS to shut down and if the shut down is automatic.

**Table 3-1: Functions requiring CC MIS to be shut down**

Function	Manual shutdown	Automatic shutdown
Test all the input/output ports automatically	X	
Load new software version		X
Change CC MIS Network Name in System Configuration screen	X	

The Maintenance and Administration system takes into account the state of CC MIS, and alters its menus accordingly. For example, the File Transfer option on the Diagnostics menu is only available when logged in through the dial-up modem port.

**Setting up a new CC MIS system (overview)**

To setup a new system proceed through the menus to access the Configuration menu. After the system has been installed and a successful login is achieved, select the Configuration option from the Maintenance and Administration Main menu. This causes the Configuration menu to be displayed. After the Configuration menu is displayed, proceed as follows:

*Non-network*

1. Configure the system - (Refer to Chapter 6)
2. Configure the switch links - (Refer to Chapter 6)
3. Configure partitions (local) - (Refer to Chapter 7)
4. Allocate disks - (Refer to Chapter 7)
5. (Optional) Define custom intervals - (Refer to Chapter 7)

*Network*

1. Configure the system - (Refer to Chapter 6 & 8)
2. Configure the switch links - (Refer to Chapter 8)
3. Configure physical network - (Refer to Chapter 8)
4. Configure partitions -(local in Chapter 7 and NAPs in Chapter 8)
5. Configure virtual network - (Refer to Chapter 8)
6. (Optional) Define custom intervals - (Refer to Chapter 7)

## Logging in

Log into CC MIS Maintenance and Administration in order to:

- monitor system performance
- configure hardware and software
- install software upgrades

After a successful login, the system displays the CC MIS Maintenance and Administration menu. The menu options reflect the state of the CC MIS. The figure below shows the main menu for CC MIS.

Figure 3.2 Maintenance main menu (CC MIS operating)

```

Call Center MIS Maintenance and Administration [LINUX]
Release 5.1.0.BNR.39

Run State Utilities
Backup and Restore Utilities
System Upgrade Utilities
Diagnostics
Modify Password
Configuration
Help
Logout

Press r,b,s,d,m,c,h or l and RETURN:

```

The Operating System Configuration command is displayed on PowerPC platforms only.

## Constraints

When logging into Maintenance and Administration, you are logging into UNIX. This is not the same as a supervisor logging into CC MIS from a supervisor terminal.



### Unauthorized use of console

Anyone can change your password through the Modify Password function of the main menu. This terminal provides direct access to CC MIS configuration. Improper use of this tool can cause system outage.

Be cautious about leaving your maintenance console logged on. This terminal provides direct access to CC MIS configuration.



### Password Expiration Prompt

If the date and time on the CC MIS host is set back more than six or more months from the current date and time, and you log in as root or maint, the system prompts you to enter a new password.

You must already know the root or maint password in order to log on and receive the prompt for entering the new password.

### Guidelines

Perform the steps below to log into CC MIS Maintenance and Administration.

## Step 3-1: Logging into maint

1. Verify that the system and maintenance console are on.

The system displays the following prompt:

**Console Login:**

2. Enter maint

The system displays the following prompt:

**Password:**

3. Enter password.

The system displays the Maintenance and Administration menu.

-or-

The system displays the following message:

**Login incorrect  
login:**

Repeat steps 1-3 or contact your system administrator for the password.



## Accessing on-line help

On-line help is available from all Maintenance and Administration menus. The help facility explains the menu choices available to you from the screen. While the help system displays on your console, the Maintenance and Administration menus and functions are not available to you.

### Accessing help in menus

Perform the steps below to access the help facility in menus.

## Step 3-2: Accessing on-line help in maintenance menus

1. From a menu, press h.

The system displays information about the menu options.

Note: User interface screens in the Maintenance interface have help that is accessed through the <HELP> key (or appropriate function key). Press the <HELP> key to access the help text for these screens. (See step 3-3.)

2. Use the space bar or <Return> to page down the help text.

To go back to the previous page, enter -1 and press <Return>.

Note: The help screens for menu windows are presented on screen using the UNIX pg command. (The pg command is transparent to the user). Type h to view a list of possible pg commands. Press <Return> to exit this list and return to the help text.

3. Type q to exit help.

## Accessing the help in screens

Perform the steps in Procedure 3-3 to access the help facility in user interface screens.

### Step 3-3: Accessing on-line help in user interface screens

1. User interface screens in the Maintenance interface have help that is accessed using the Help command (shown in the lower portion of the screen as <Help>=Help, F9=Help, or another designated function key xx=Help).

Press the HELP key (or appropriate function key) to access the help screen.

2. Depending on your terminal type, you can use one of the following to scroll through the help text.

Prev - Returns to the previous screen.

Scrn - Moves to the next screen.

- or -

Page Up - Returns to the previous screen.

Page Down - Moves to the next screen

-or-

Up arrow - Returns to the previous line of text.

Down arrow - Moves to the next line of text.

Note: Key names depends on terminal type.

3. Press the <Help> key (or function key) again to exit help.

## Changing your password

Your password protects access to maintenance functions. You can change the password to maintain secured access to these system functions, and ultimately to the system configuration.



**The user ID maint, and the password are case sensitive.**

The password SUPR1 is not the same as supr1.

### Guidelines

Perform the steps below to change your password.

## Step 3-4: Changing the maint password

1. Access the Maintenance and Administration menu.
2. Enter *m* to change the password. The system displays the following prompt:  
**Do you want to change the maint user id password? (yes/no)**
3. Enter *y* to change the password or enter *n* to keep the existing password and return to the Maintenance and Administration menu.

When *y* is entered, the system displays the following prompt:

**Enter a new password.**

**New password:**

4. Enter a new password (minimum of one character). The system displays the following prompt:  
**Re-enter new password:**
5. Re-enter the password to confirm your change. The system returns to the Maintenance and Administration menu.



If you fail to confirm the new password, the system (after three attempts) will cancel the password change and will send you back to the Main menu.



---

**Do not leave you console logged in and unattended.**

Anyone can change your password through the Modify Password function of the main menu. This terminal provides direct access to CC MIS configuration. Improper use of this tool can cause system outage.

If you log out of the maintenance console without knowing that your password has been changed, you won't be able to log on to Maintenance and Administration without obtaining the new password from the person who changed it.

---

## Logging out

You log out of Maintenance and Administration after you have completed your work. By logging out, you protect the system configuration.

### Guidelines

Perform the steps in the procedure below to log out of CC MIS Maintenance and Administration.

## Step 3-5: Logging out of maint

1. Access the Maintenance and Administration menu.
2. Enter l to log out from the menu.

The system displays the console login prompt.



### Unauthorized use of console

Anyone can change your password through the Modify Password function of the main menu. This terminal provides direct access to CC MIS configuration. Improper use of this tool can cause system outage.

Be cautious about leaving your maintenance console logged on. This terminal provides direct access to CC MIS configuration.

## Maintenance menus and screens

### Maintenance and administration main menu

The main menu for the Maintenance interface is displayed upon successful login to CC MIS.

Figure 3.3 Maintenance and Administration menu

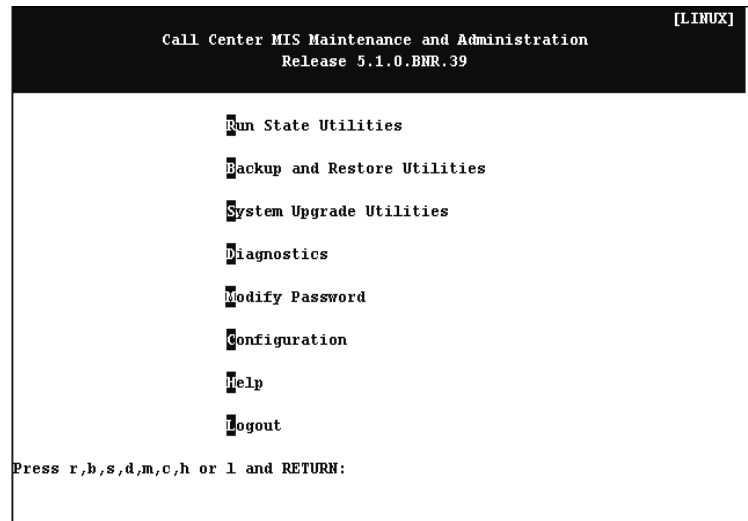

The Operating System Configuration command is displayed on PowerPC platforms only.

### Configuration menu

The configuration menu is the first menu accessed from the main menu to configure the system, establish switch links, and define partitions. The CC MIS system must be running in order to use the configuration utility to add or delete partitions, change data storage parameters, and change disk allocation.

Figure 3.4 Configuration menu

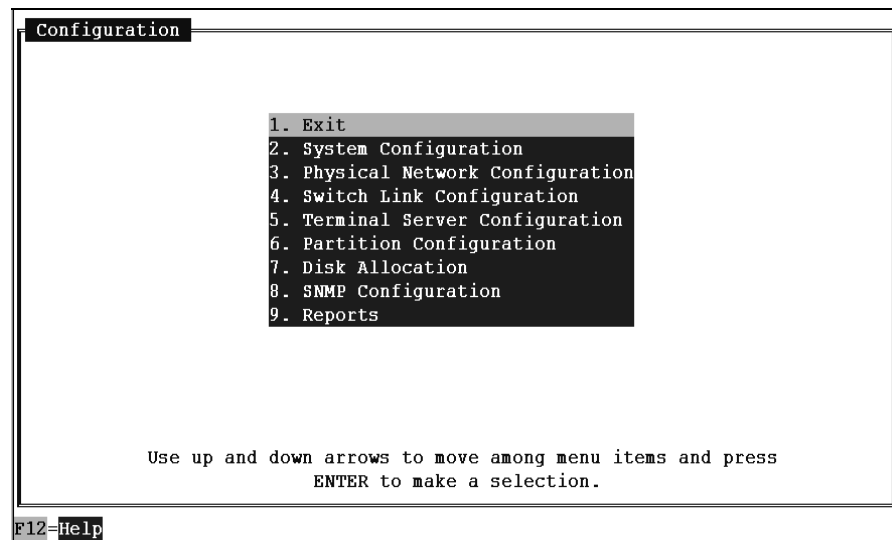

### System upgrade utility menu

The system upgrade utility menu provides access to commands used for upgrading software versions.

Figure 3.5 System upgrade utility menu

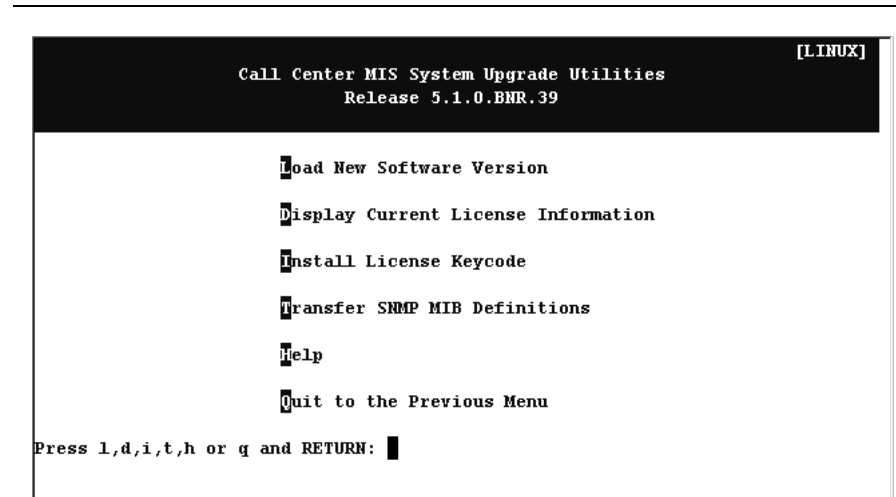

### Backup and restore menu

The backup and restore menu provides access to commands used for customer backup of data. It provides for the restoration of data in the event of data corruption.

Figure 3.6 Backup and restore menu

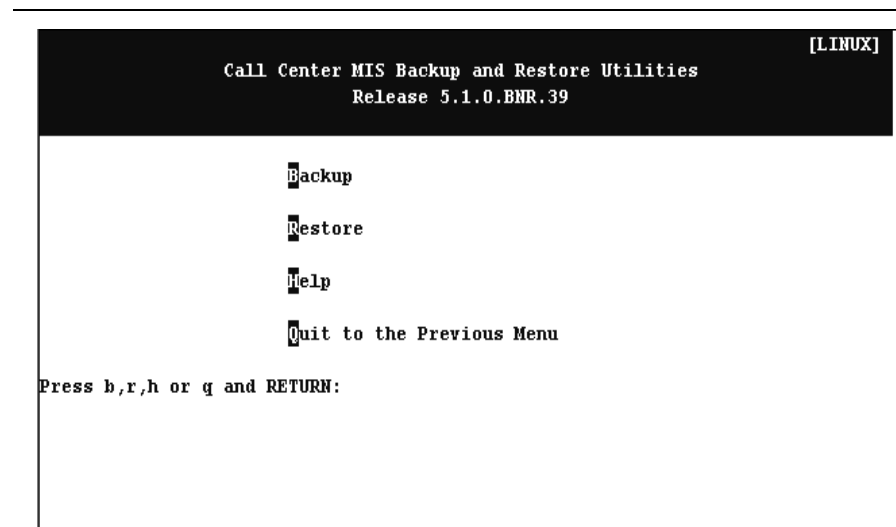

### Run state utilities menu

The run state utilities menu provides access to commands used for start-up and shutdown of the CC MIS system and individual partitions, and contains the update switch configuration data command (formerly available in the Supervisor interface).

Figure 3.7 Run state utilities menu

```

Call Center MIS Run State Utilities [LINUX]
Release 5.1.0.BNR.39

Update Switch Configuration Data
Partition Startup and Shutdown
Shutdown the CC MIS System
Power Down
Help
Quit to the Previous Menu

Press u,p,s,d,h or q and RETURN:

```

### Diagnostics menu

The diagnostics menu provides access to diagnostic programs for CC MIS.

Figure 3.8 Diagnostics menu

```

Call Center MIS Diagnostics [MISVME5]
Release 5.1.0.BNR.40

Display Free Disk Space      Test Individual I/O Ports
Logs                         View System Monitor
Reset Modem Port
Link Trace
X.25 Diagnostics
TCP/IP Switch Link Diagnostics
Help                          Quit

Press d,i,l,v,r,t,x,s,h or q and RETURN:

```





The File Transfer command is available only and displayed on this menu if you are logged in through the maintenance modem. This command is not available on the PowerPC platform.





## Section 4: Shutdown, Startup, and Power down



 *Shut down CC MIS*

 *Power up CC MIS*

 *Start up CC MIS*

 *Power failures*

 *Power down CC MIS*

### Introduction

This chapter contains procedures for the following commands and functions: shut down, start up, and power down CC MIS.

### Shut down CC MIS

CC MIS must be manually shut down before certain functions are performed through the maintenance console. (CC MIS is automatically shutdown for functions requiring shutdown.) The shutdown command leaves the operating system and other non-CC MIS software running. The system is shut down from the Run State Utilities menu.

Figure 4.1 Run state utilities menu

```

Call Center MIS Run State Utilities [LINUX]
Release 5.1.0.BMR.39

  U pdate Switch Configuration Data
  P artition Startup and Shutdown
  S hutdown the CC MIS System
  P ower D own
  H elp
  Q uit to the Previous Menu

Press u,p,s,d,h or q and RETURN:

```

## Start up CC MIS

Perform a start up of CC MIS if you shutdown CC MIS.

## Start up/shut down partitions

Perform start up and shut down of CC MIS partitions from the Run State Utilities menu. It is also available in Partition Configuration screen (refer to Chapter 7).

## Power down CC MIS

The Power down command is used to remove power to CC MIS. The power down command is selected from the Run State Utilities menu.



Use the power button to power up CC MIS after a power down.

## Shut down CC MIS

Using this command shuts down the CC MIS software, leaving the operating system, non-CC MIS programs, and CC MIS maintenance software running.



If you want to shut down both the CC MIS software and the UNIX operating system, you must use the power down command.

If you request a maintenance function that can only be performed with CC MIS shutdown, the maintenance and administration software automatically shuts down CC MIS. The system does not need to be shut down manually. (The exceptions are the Test All I/O Ports function and changing the Network Name, both of which require manual shutdown.)



### Automatic logout

CC MIS supervisor's are automatically logged out if the CC MIS system is shut down.

Perform the steps below to manually shut down CC MIS.

## Step 4-1: Shutting down CC MIS

1. Ensure that CC MIS is operating and access the Maintenance and Administration menu.



### CC MIS shutdown

Advise supervisors that you are shutting down the CC MIS system. Supervisors do not have access to CC MIS after you have shut down the system.

2. Enter *r* to display the Run State Utilities menu.
3. From the Run State Utilities menu, enter *s* to shut down the CC MIS system. The system displays the following warning:

### WARNING!

**Proceeding with this operation will bring down all CC MIS software.  
Ready? (yes/quit)**

4. Enter *y*.

Note: Enter *q* to abort the shut down and return to the menu.

The system displays the following message:

**CC MIS terminating. . .  
CC MIS has been shutdown.  
Use the Start the CC MIS System command to restart it.  
Press RETURN to continue.**

5. Press <Return>.

The system displays the Run State Utilities menu. The third option has changed to Start the CC MIS System.

## Start up CC MIS

This command starts up CC MIS after it has been shut down (not powered down). CC MIS is started after certain maintenance tasks have been completed, such as automatically testing all configured ports.

Perform the steps below to start CC MIS.

### Step 4-2: Starting CC MIS

1. Access the Maintenance and Administration menu.
2. Enter *r* to display the Run State Utilities menu.
3. From the Run State Utilities menu, enter *s* to start the CC MIS system.

Note: CC MIS must be shut down to access the correct option.

The system displays the following messages:

**Start the CC MIS system**

**Is the date and time [date and time] correct? (yes/no/quit)**

Note: If the time and date are wrong, enter *n*. The prompt Enter the correct time and date [mmddHHMMyy]: is displayed. Enter correct time and date and press the <Return> key. The system displays the following message again:

**Is the date and time [date and time] correct? (yes/no/quit)**

Note: The time and date for the system are specified here (not read from the switch - unless link is synchronized with switch). If the system experiences "drifting time" it will need to be shut down and restarted and the date/time specified again.

4. Enter *y*.

Note: Enter *q* to abort the startup and return to the menu.

The system displays the following messages:

**Starting CC MIS. . . .**

**CC MIS has been started.**

**Press RETURN to continue.**

5. Press <Return>.

The system displays the Run State Utilities menu. The third option has changed to Shutdown the CC MIS System.

## Power down CC MIS

This command powers down both CC MIS and the UNIX operating system. You power down CC MIS when you want to stop running all software or remove power from the system in order to service hardware or move the system.

Perform the steps in below to power down CC MIS.

### Step 4-3: Power down CC MIS

1. Access the Maintenance and Administration menu.



#### CC MIS shutdown

Advise supervisors that you are powering down the CC MIS system. Supervisors do not have access to CC MIS after you have powered down the system.

2. Enter *r* to display the Run State Utilities menu.
3. Enter *d* to power down the CC MIS system and the UNIX operating system. The system displays the following warning:

#### Prepare the system for powering down.

**This command shuts down the CC MIS system (if it is currently running), then shuts down the operating system in preparation for removing power from the system.**

**Ready (yes/quit)?**

4. Enter *y*. (To quit and return to the menu, enter *q*.)  
The system displays the following message:

**CC MIS terminating ...**

**Beginning operating system shutdown.**

**SHUTDOWN started**

**Tues Apr6 14:11:40 CDT 1995**

**THE SYSTEM IS BEING SHUT DOWN NOW !!!**

**Log off now or risk your files being damaged.**

**NOTICE: System secured for powering down.**



#### WAIT - corrupted files

After performing step 4, the user must wait for the message NOTICE: System secured for powering down before proceeding to step 5. Failure to wait may result in corrupted files on the disk.

5. After the message NOTICE: System secured for powering down is displayed, turn off power with the power button on the front of the VME.
6. Unplug power cord from the wall outlet or UPS. (Recommended)

The actual message displayed in Step 4 differs slightly between platforms.

On the PowerPC platform the actual NOTICE text is different than the text shown in this example.

## Power up the CC MIS system

The steps are used to power up both CC MIS and the UNIX operating system. Power up CC MIS after it has been powered down using the power down command. Perform the steps below to start CC MIS.



Perform only step 1 if the system was running but was powered down. Perform all of the steps if the system was shutdown prior to power down.

### Step 4-4: Powering up CC MIS

1. Turn on power with the power button on the VME.
2. After the system has completed start up, the system displays the following prompt:

**Console login:**

Note: System start up may take several minutes.

3. Enter *maint* The system displays the following prompt:

**Password:**

4. Enter the password. The Maintenance and Administration menu is displayed.
5. Select the Run State Utilities option. The Run State Utilities menu is displayed.
6. Enter *s* to start the CC MIS System. If the CC MIS was running before the system was powered down, it will automatically be restarted. The system displays the following messages:

**Start the CC MIS system**

**Time:**

**Date:**

**Ready? (yes/quit)**

7. Enter *y*. (Enter *q* to abort the startup and return to the Maintenance and Administration menu.) The system displays the following messages:

**Starting CC MIS. . .**

**CC MIS has been started.**

**Press RETURN to return to the Main Menu.**

8. Press <Return>

The system displays the Run State Utilities menu. The third option of the menu has changed to "Shutdown the CC MIS System" because the CC MIS is operating.

## Power failures

The CC MIS system uses a Uninterruptable power supply (UPS) to retain power during power failures. If a power failure exceeds the UPS capability, then the CC MIS system must be powered down.

Note: When a power failure occurs, the user receives console messages stating that the system will shutdown in "xx" minutes. These messages appear every two minutes until the count is down to zero minutes. Afterwards, the system begins the shutdown process.

### CC MIS was not running

If CC MIS was not running when the power failure occurred, perform the steps in Step 4-4 (on the previous page) to power up CC MIS.

### CC MIS was running

If CC MIS was running when the power failure occurred, perform the step below to recover from the power failure.

## Step 4-5: Recovering from a power failure

1. Turn on power with the power button on the VME.
2. CC MIS will automatically restart.







# Section 5: Backing up and Restoring data

# 5

 *Accessing the backup and restore functions*

 *Restoring customer data*

 *Using a DATs tape and drive*

 *Backing up customer data*

## Introduction

The Backup and Restore Utilities allows the following functions to be performed

- backup customer data to tape
- restore customer data from tape

These functions are accessed through the Backup and Restore Utilities menu, as shown in the figure below.

Figure 5.1 Backup and restore menu

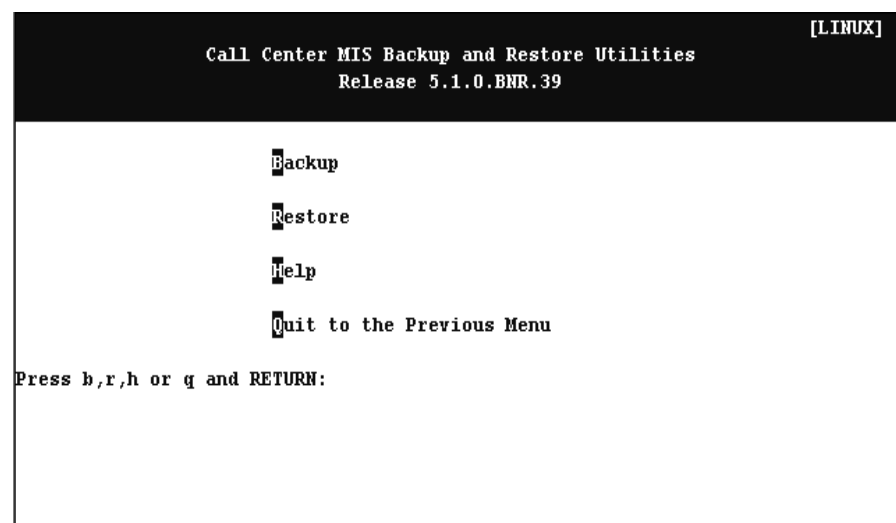

The restore functions must be performed when the affected partitions are stopped, while the backup functions can be performed when the affected partitions are running or stopped. CC MIS must be running in order for backup or restore functions to be performed.

Perform the step below to access the backup and restore utilities.

### Step 5-1: Accessing the backup and restore menu

1. Enter b to access the backup and restore utilities menu.

The system displays the Backup and Restore Utilities menu.

### Using the DAT drive for backups

The DAT tape drive is used to backup customer data and to install and upgrade new software versions.

Figure 5.2 DAT drive unit

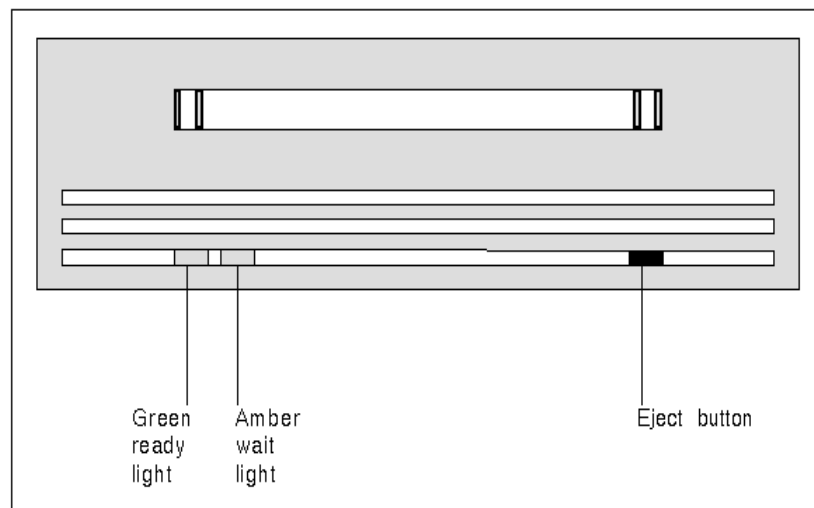

The system can be configured to perform an automatic backup each evening. If your system is configured for backups, be sure to leave a tape in the drive to record the backup.



#### Valid current data

Rotate backup tapes daily to ensure that you have a tape with valid current data from which to restore.

### Write-protecting your DAT

After backing up data, you may want to protect the tape from being written over. A write protect setting exists on the DAT, illustrated in Figure 5-3. To protect the contents of the tape, use your fingernail to move the white tab to the left. The figure below illustrates the setting for a write protected tape. To allow data to be written on a tape, move the white tab to the right.



The white tab must be all the way to the right in order to record data on a backup tape.

Figure 5.3 Digital audio tape

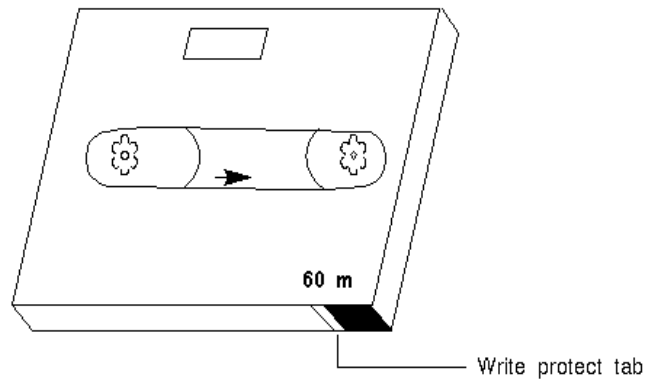

#### Use correct tape drive for backups

On systems with both a DAT drive and a cartridge tape drive, the DAT **must** be used backups. *Do not use the cartridge tape drive for backups.*



#### Damage to tape drive

Do not unload the backup tape from the tape drive during a backup. Unloading the tape may cause damage to the tape drive.

Perform the steps below when inserting a DAT in the drive. Refer to steps in this chapter to back up data.

### **Step 5-2: Inserting a DAT tape into the tape drive**

1. If the tape is for a backup or database upgrade, ensure the tape is not write protected. Otherwise, the tape should be write protected.
2. Hold the tape so that the write protect mechanism is on the right, and the tape label is up.
3. Insert the tape in the drive.  
The system readies the tape, and the ready light glows green.

Use the steps below to eject a DAT from the drive.

### **Step 5-3: Ejecting a DAT tape from the tape drive**

1. Press the eject button (when amber light is off).  
The system ejects the tape.

## **Backing up customer data**

The Backup command stores information from the CC MIS databases to tape. For systems equipped with a DAT drive and a cartridge tape drive, data is stored using the DAT drive. For systems equipped with a cartridge tape drive only, data is stored using the cartridge tape drive. You can only back up customer data when the CC MIS system is operating. Backing up customer data records the following information:

- definitions database for selected partitions
- data database for selected partitions
- configuration database

---

**Note:** Systems that store more than 2 GBytes of data may not be able to perform an unattended nightly backup. The information being backed up may not fit on a single DAT tape.

---

### Automatic backups

The CC MIS system automatically performs backups every 24 hours, if the "Nightly Backups" is enabled for the partition. It will backup every partition for which this option is enabled (see partitions options in Chapter 7). To verify that your daily database backup has been successful, view the error log and look for one of the following messages: Nightly Backup was successful, or Nightly Backup failed. To keep one week of data as a backup, use a total of seven tapes for the daily backup. Change the tape each day, storing the tape from the previous day. Reuse the tapes in a seven day cycle. (Do not exceed the tape manufacturer's recommended usage.)

The number of days, weeks, or months that data is stored is determined by the parameters set through the storage calculator. The specified duration identifies the period of time data is saved before being automatically purged from the database.

### Manual backups

Manual backups provide additional control over what is backed up. The manual selections for BACKUP and RESTORE are as follows:

- For configuration only backup and restore - This backs up and restores the information defined through the maintenance configuration screens.
- For partition/definition database only - This backs up and restores the information defined through admin, reports, displays, config screens, and so on. That includes all definitions that were created by the supervisor.
- For partition/data database only - This backs up only historical statistics. This is the data used in the custom and standard reports. This is NOT data shown on real-time displays. (Not applicable for NAPs.)

If the system crashed and you need to restore all data, you restore the configuration data first, then you restore both the partition/system database and partition/data database to restore all data for all partitions.



There is no difference between manual and nightly backups when all options are selected during a manual backup.

Figure 5.4 Backup screen

Backup	
Ad hoc Set	
Configuration Database	Backup? Yes
Steve	No
Dave	No
Abbey	Yes
Feng	No
Ruben	Yes
Backup Information	
The last backup completed successfully.	

F12=Help F1=Commands F2=Options

The Backup screen is shown with a sample ad hoc backup set. The default "Backup?" value will be "yes" for the configuration database.

The default "Backup?" value for each partition is "yes" if the nightly backup for the partition is enabled (see Partition Options in Chapter 7).

The default for NAPs is "yes" for Definition Database only.

The lower portion of the screen displays information about the current backup. Messages such as "Insert new tape" are displayed in this area. The tape number and item being backed up are also displayed.

### Backup screen commands

The following commands are accessed on the Backup screen by pressing the F1 soft-key.

**Table 5-1: Backup screen commands**

Command	Function
Exit	Exits the current screen.
Start backup	Initiates an ad hoc backup.
Continue backup	Used to continue backup when end-of-tape is reached or some other recoverable error has occurred.
Cancel backup	Cancels the current backup (after confirmation).
View backup log	Allows the user to view the backup log without having to go through the Logs screen.

**Constraints**

This procedure only backs up CC MIS data; it does not store information from the ACD database tables on the DMS-ACD.



You can back up customer data only when the CC MIS system is operating.

**Damage to tape drive**

Do not unload the backup tape from the tape drive during a backup. Unloading the tape may cause damage to the tape drive.

**Use correct tape drive**

If your system has both the DAT drive and the cartridge tape drive, you must use the DAT drive to back up customer data.

## Guidelines

Use the steps below to back up customer data.

### Step 5-4: Backing up customer data

1. Access the Backup and Restore Utilities menu.
2. Enter *b* to back up customer data.  
  
The system displays the Backup screen.
3. Move cursor to the backup field for the partition and press the Options function key for the Options menu. Select the desired setting [1. No, 2. Yes, 3. Yes (Definition Only), or 4. Yes (Data Only)].
4. Press the Commands function key to display the commands menu.
5. Select the Start Backup command (item 2).
6. A pop-up dialog box appears with the following message:

**Insert a blank tape and wait until the tape drive is ready. Press "y" when ready, "q" to quit.**

**Ready? (y/q)**

7. Enter *y* to begin the backup.
8. During the backup process, view the Backup Information area of the Backup screen for important information and messages regarding the progress of the backup.  
  
Note: A message will be displayed when a new tape needs to be inserted. This area will also display the tape number and the name of the item being backed up.
9. When prompted, remove the tape from the cartridge tape drive by moving the eject latch from the right to the left or by pressing the eject button.
10. To exit the Backup screen, press the Commands function key and select the Exit option.

The Backup and Restore Utilities menu is displayed.



## Restoring customer data from tape

The Restore command can be used to restore customer data from a backup tape in the event of a disk crash or other data corruption. This process loads backup copies of the CC MIS database from a tape and replaces existing databases.

Therefore, this procedure should be performed only if the existing data has been corrupted or is no longer valid.

This procedure restores the following information from tape:

- definitions database for selected partitions
- data database for selected partitions (not applicable for NAPs)
- configuration database

### Constraints

You can restore data from a backup tape only when the CC MIS software is operating.

#### Release 4.1 / 5.0

The system will not allow a backup tape created on another CC MIS release to be restored onto the 5.0 system.

#### Corrupted data



Be sure that the software release of CC MIS used to create your backup tape matches the software release of CC MIS that restores the data. Data will be corrupted and the system may not function as designed if the releases do not match.

#### Improper database size



When restoring a database from a backup tape, the size of each partition's historical database on the backup tape must be the same size or smaller than the configured storage limit.



Restoring a backup that was performed prior to hardware changes (for example, removing a disk) may result in configuration problems.

Figure 5.5 Restore screen

The screenshot shows a terminal window titled "Restore". It contains two main sections:

- Ad hoc Set**: A table with two columns: "Configuration Database" and "Restore?". The "Restore?" column has a grey highlight on the "Yes" row for "Steve".
- Restore Information**: A large empty rectangular box below the table.

At the bottom of the window, there are three function key shortcuts: **F12=Help**, **F1=Commands**, and **F2=Options**.

Configuration Database	Restore?
Steve	Yes
Dave	No
Abbey	Yes
Feng	No
Ruben	Yes

The Restore screen is shown with a sample ad hoc backup set. The lower portion of the screen displays information about the current restoration. Messages such as "Insert tape" are displayed in this area. The tape number and item being restored are also displayed.



The Restore process for the configuration database cannot be performed if any partitions are running. Restoration of a partition also requires that partition be stopped.

Perform the steps below to restore customer data from tape.

## Step 5-5: Restoring customer data

1. Access the Backup and Restore Utilities menu.
2. Enter *r* to restore customer data. The system displays the Restore screen.

Note: The Restore process for the configuration database cannot be performed if any partitions are running. Restoration of a partition also requires that partition be stopped. A prompt is displayed to shut down the partition(s), as needed.

3. On the restore screen, identify the configuration database or partition data to be restored. (Use the Options function key to display the Options menu.)
4. Press the Commands function key to display the commands menu.
5. Select the Start Restore command. A pop-up dialog box appears that may include the following messages:

**Warning: the existing contents of each database being restored will be removed immediately before the database is restored from tape.**

**Warning: restoring the configuration database with a different hardware configuration than the current system may have undesirable results.**

**Warning: restoring the configuration database will shutdown ALL partitions.**

**Are you sure? (y/q)**

6. Enter *y* to continue.

Note: Enter *q* to abort the restore process.

If you enter *y*, the following message appears:

**Insert the tape and wait until the tape drive is ready. Press "y" when ready, "q" to quit.**

**Ready? (y/q)**

Note: Use the cartridge tape drive or the DAT drive, depending on your system configuration and available disk size.

7. Enter *y* to restore data from tape. Enter *q* to abort the restore process.

*Continued on next page ...*

**(continued)**

8. During the restore process, view the Restore Information area of the Restore screen for important information and messages regarding the progress of the backup.

Note: A message will be displayed when a new tape needs to be inserted. This area will also display the tape number and the name of the item being backed up.

9. When prompted, remove the tape from the cartridge tape drive by moving the eject latch from the right to the left or by pressing the eject button.

10. To exit the Backup screen, press the Commands function key and select the Exit option.

The Backup and Restore Utilities menu is displayed.

Note: Partitions stopped by the Restore process must be manually restarted.

## Section 6: Configuring the CC MIS system



 *System configuration screen*

 *Terminal server configuration screen*

 *Port Allocation screen*

 *SNMP configuration screen*

 *Switch link configuration*

 *System configuration reports*

### Networked CC MIS

If you are using the networking feature, refer to the information in Chapter 8.

### Introduction

Through the Configuration main menu, you access submenus that allow you to define or alter parameters related to CC MIS system configuration. The procedure for establishing a CC MIS system is as follows:

- System configuration screen - specify system name, LAN parameters, and maintenance printer.
- Switch link configuration - select link type and specify link information.
- Terminal server configuration - specify LAN-based terminal servers available for CC MIS.
- Partition configuration - add a partition, then specify the following:
  - connection parameters
  - partition options
  - storage calculator
  - disk allocation
  - serial terminals
  - static LAN terminals
  - printers
  - wallboards
  - master privilege definition

You access the Configuration main menu, as shown in Figure 6-1, from the Maintenance and Administration menu.

Figure 6.1 Configuration main menu

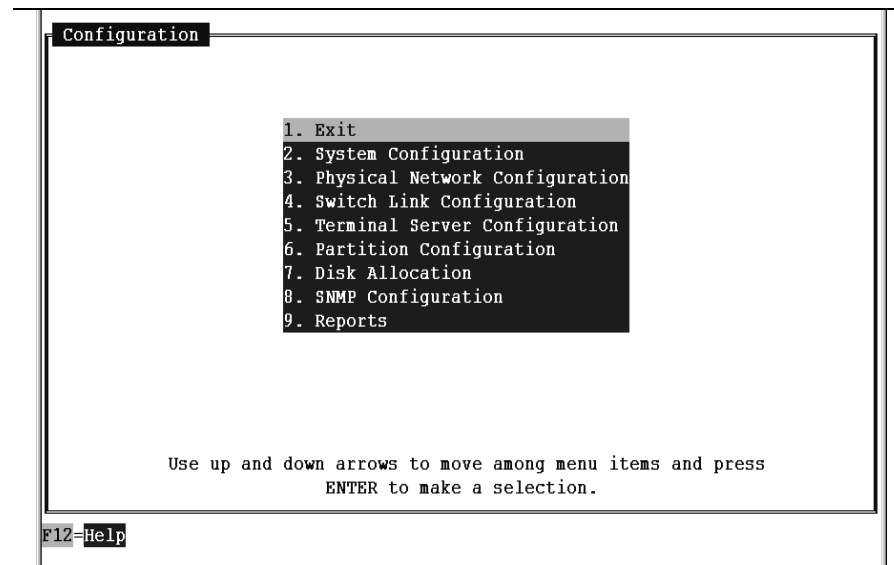

**Note:** The Physical network Configuration option is only displayed on a networked node.

### Accessing the Configuration main menu

You access all configuration functions from the Configuration main menu. CC MIS must be running to perform configuration.

### Guidelines

Perform the steps below to access the Configuration main menu.

## Step 6-1: Accessing the Configuration menu

1. Access the Maintenance and Administration menu.
2. Select *c* to access the Configuration main menu.

The system displays the Configuration main menu.

## System Configuration

The system configuration screen contains system-wide data. This is the first screen accessed when setting up a new system. Information contained in this screen includes system name, network parameters, and the maintenance printer setup.

Figure 6.2 System configuration screen

### PowerPC platform version

```

System Configuration

System Name:          PowerPC1
** CC MIS Network Name:  CCMISNET

LAN Parameters:
Network Hostname:    carpyc08
Network Address:     47.81.160.177
Network Mask:        0xfffff000
Default Gateway:     47.81.160.1

Maintenance Printer Definition:
Unix Printer:        FX870
Printer Model:       EPSON MX/FX - 8.5"
Printer Name:        FX870

** NOTE: The system must be shut down to change the network name.

F12=Help  F1=Commands

```

### 88K-based platform version

```

System Configuration

System Name:          Spin
** CC MIS Network Name:  CCMISNET

LAN Parameters:
Network Hostname:    carpyb
Network Address:     47.81.160.105
Network Mask:        0xfffff000
Default Gateway:     47.81.160.1

Maintenance Printer Definition:
Port:                lp0
Modem:
Baud Rate:
Printer Model:       HP LaserJet
Printer Name:        Maint Laser

** NOTE: The system must be shut down to change the network name.

F12=Help  F1=Commands  F4= Port Allocation

```

## Guidelines

Perform the steps below to access the System Configuration screen.

### Step 6-2: Accessing the System Configuration screen

1. Access the Maintenance and Administration menu.
2. Select Configuration to access the Configuration main menu.  
  
The system displays the Configuration main menu.
3. Select System Configuration to access the System Configuration screen.

## Field descriptions

The system configuration screen fields are described in Table 6-1.

**Table 6-1: System configuration field descriptions**

Field	Description
System Name	The system name will appear on configuration reports. This name can be up to 16 characters in length.
Network Hostname	This name can be up to 15 characters in length. This is the name that appears when the "uname -n" command is executed on the system at the UNIX prompt.
Network Address	This is the network IP address that uniquely identifies the system on the LAN.
Netmask	Used by routers to determine which bits of an IP address is the network address.
Default Gateway	Address of the gateway to the network on which CC MIS is located.



Table 6-1: System configuration field descriptions

Field	Description
Maintenance Printer (187 or 197 platforms)	<p>Printer where the maintenance reports and logs are spooled. This is a direct-connect, hard-wired printer. The maintenance printer can be added to any port which is not currently in use by a partition.</p> <p>Press the Options menu to select ports, modem, baud rate, and printer models. (Up to 25 characters can be entered for the printer name.) Use the port allocation key to view port allocations.</p> <p><b>Note 1:</b> The maintenance (system) printer can be connected to the VME using the parallel port.</p> <p><b>Note 2:</b> Graphical reports cannot be printed on the Maintenance Printer.</p>
Unix Printer (PowerPC platforms)	<p>Designated (unix-defined) printer where the maintenance reports and logs are spooled.</p> <p>Printers on the PowerPC must first be configured using the Add a Unix Printer command in the Operating System Configuration menu before they can be configured into CC MIS.</p>

## Port Allocation

The Port allocation screen is a view-only screen. It allows you to view a list of ports on the system and identifies the partition to which they are allocated. To change the port allocations, you must access the Port Configuration screen (described in Chapter 7).

Figure 6.3 Port Allocation screen

Port Allocation (Display Only)				
PORT	PARTITION	MODEM	BAUD RATE	DEVICE TYPE
console	Base	No	9600	
contty	Base	Yes	9600	
contty02	Base	No	9600	
contty03	Base	No	9600	
lp0	Base			Printer
m337_c0d0		No	9600	
m337_c0d1		No	9600	
m337_c0d2		No	9600	
m337_c0d3		Yes	9600	
m337_c0d4		No	9600	
m337_c0d5		No	9600	
m337_c0d6		No	9600	
m337_c0d7		Yes	9600	
m337_c0d8	S6	No	38400	
m337_c0d9		No	9600	
m337_c0d10		No	9600	
m337_c0d11		No	9600	

F12=Help F1=Exit

## Constraints

Port console is configured as a console device, and port contty is always configured as a dialup maintenance device for system maintenance. You cannot change these port assignments. These ports, along with the Maintenance printer, belong to the base partition.

Ports contty02 and contty03 are located on the main processor board. Configuring devices on these ports requires more processor time than if you use the other available ports. If you use these ports to connect an ASCII (dumb) terminal, you need to use line drivers or null modems.



These ports are not recommended for Windows PCs.

Port lp0 is the parallel printer port located on the processor board. There are no modem or baud rate fields associated with this port.

**Guidelines**

Perform the steps below to view the port allocation screen.

**Step 6-3: Accessing the Port Allocation screen**

1. Access the Port Allocation screen by pressing the Port Allocation function key from the System Configuration screen.
2. Select Exit to return to the Main Menu.

## Switch link configuration

The switch link configuration screen allows you to create multiple link definitions. Links can be live or simulated. This function provides a means of defining logical links that can be used by a partition. There can be up to six link definitions in the switch link configuration screen - four live and two simulated. (Note that on a PowerPC there can be 12 live links.)

Upon entering the switch link configuration, the screen appears as shown in Figure 6-4.

Figure 6.4 Switch link configuration screen - Initial

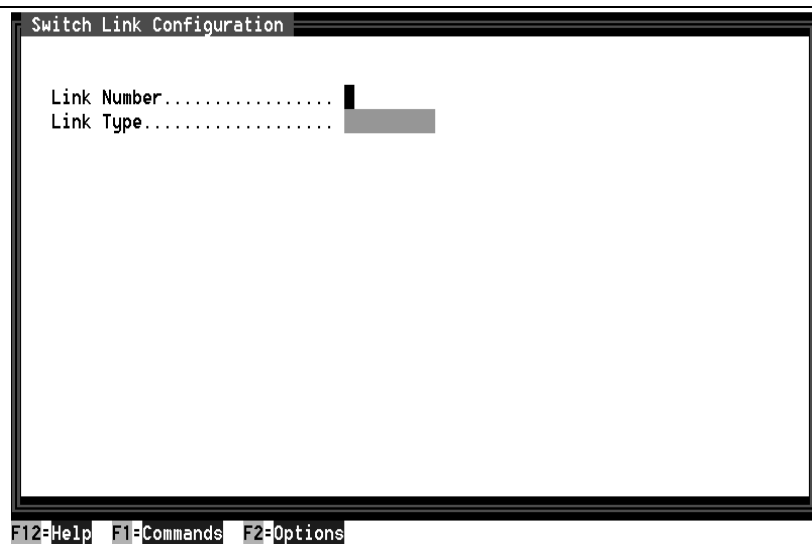

### Guidelines

Perform the steps below to access the Switch Link Configuration screen.

## Step 6-4: Accessing the Switch Link Configuration screen

1. Access the Maintenance and Administration menu.
2. Select Configuration to access the Configuration main menu.  
The system displays the Configuration main menu.
3. Select Switch Link Configuration to access the Switch Link Configuration screen.

**Switch Codes**

The Switch Code field allows three additional digits to be prepended to all directory numbers (DNs) received from the switch. This field is normally left blank. This field should be used if you are using the CC MIS networking feature in a private network where duplicate DN's appear on more than one switch. Using a unique switch code for each switch in the private network, CC MIS can make the duplicated DN's unique, thereby allowing the CC MIS networking feature to operate properly.

**Command menu options**

The Switch Link Configuration screen has the following commands on the commands menu:

- Exit
- Clear the form
- Read an existing link definition
- Save link definition
- Delete an existing link definition

**Live link**

If live is chosen as the link type, the remainder of the fields are displayed on the screen. The switch link configuration screen for a live link appears as shown in Figure 6-5.

Live link definitions are specified to obtain a live connection to the DMS/MSL-100.

Figure 6.5 Switch link configuration screen - live link



The Reinit Time field is used to specify a time (in 24-hour format) that the system will request re-initialization from the switch. This field is left blank when no daily re-initialization is required.

The secondary link field is available only if the link redundancy option is enabled on the load tape. It can be left blank if link redundancy is not desired for this live link definition.

Time for the system is set and timezone differences are adjusted using the Synchronize to Switch Time and Timezone Adjustment fields.

**Note:** In Release 5.1, partitions on a single node can have different time zones than the rest of the system. This feature is set using the Partition Options screen.

On the PowerPC, the DTE/DCE setup for a port is determined by the hardware and cannot be changed. This setting can be changed on 88K-based platforms.

### Simulator link

If simulator is chosen as the link type, the Simulator Configuration field is displayed on the screen. The Switch Link Configuration screen for a simulator link appears as shown in Figure 6-6.

Simulator link definitions are specified to set aside a link number to specify that a partition should be connected to the simulator.

Figure 6.6 Switch link configuration screen - Simulator link

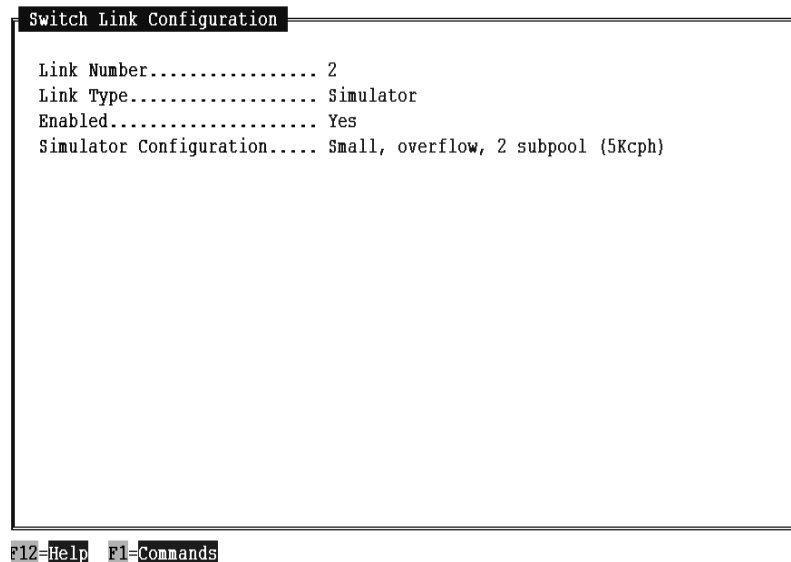

The configuration information is explained in the Help text. Select the text and press the Help function key to view the Help text.

## Terminal Server Configuration

The Terminal Server screen allows you to specify LAN-based terminal servers that are available for CC MIS.

Figure 6.7 Terminal Server screen

Terminal Server Configuration			
IP ADDRESS	NAME	BASE TCP PORT	#PORTS
47.01.160.176	RCS1	8000	16

F12=Help F1=Commands F3=Edit field F5=Add F6=Delete F7=Configure

### Guidelines

Perform the steps below to access the Terminal Server Configuration screen.

## Step 6-5: Accessing the Terminal Server screen

1. Access the Maintenance and Administration menu.
2. Select Configuration to access the Configuration main menu.  
The system displays the Configuration main menu.
3. Select Terminal Server Configuration to access the Terminal Server Configuration screen.

## Adding a Terminal Server

To add a new terminal server, press the Add function key. The dialog (shown in the figure below) appears on the screen. Enter the IP address and press the <Return> key.

Figure 6.8 Adding a Terminal Server

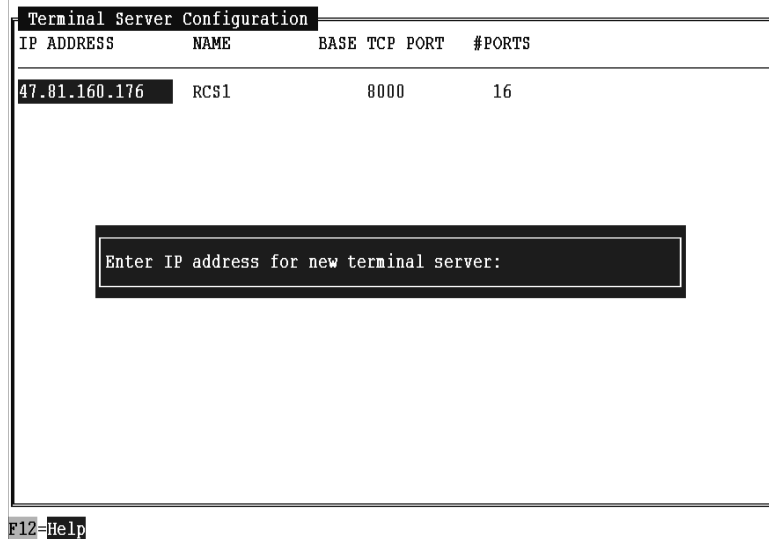

## Configuring a Terminal Server

To configure a terminal server, press the Configure function key. The dialog (shown in the figure below) appears on the screen. Follow the instructions on the screen to enter and configure the terminal server.

Figure 6.9 Configuring a Terminal Server

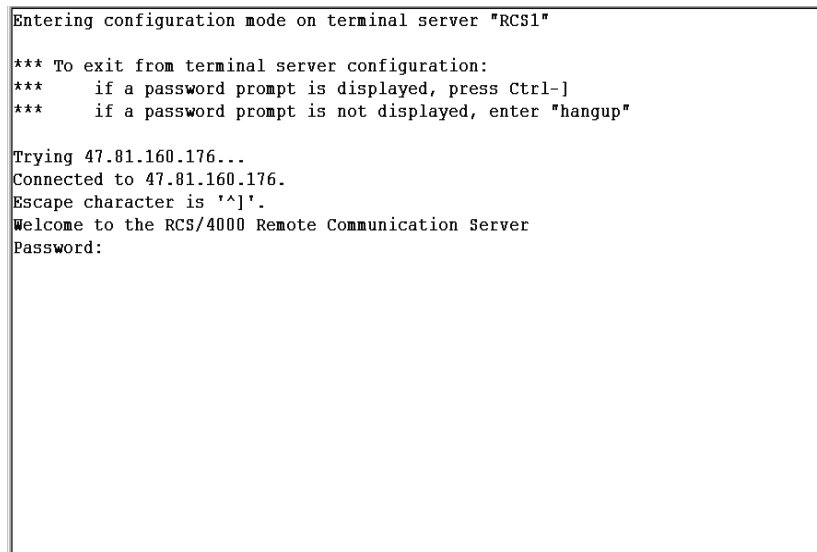



### Editing a field

To edit the fields of a terminal server listed on the Terminal Server screen, press the Edit Field function key.

Figure 6.10 Editing a field on the Terminal Server screen

IP ADDRESS	NAME	BASE TCP PORT	#PORTS
47.81.160.176	RCS1	8000	16

F12=Help F1=Commands F3=Edit field F5=Add F6=Delete F7=Configure

## SNMP configuration

The SNMP configuration screen displays information concerning the three CC MIS SNMP communities: Read-only, Read-write, and Trap. These communities consists of:

- community name
- access mode
- set of IP addresses (of SNMP managers)



Due to the technical nature of the SNMP capability, a background in network management and the SNMP protocol is recommended for administrators and users of this feature.

The SNMP configuration screen is used to define Network Management Systems (NMS) that may have access to the system-wide information defined by the Management Information Bases (MIBs). The two types of MIBs are:

- CC MIS System MIB
- MIB-2 (standard MIB)

The SNMP configuration screen is shown in the figure below.

Figure 6.11 SNMP configuration

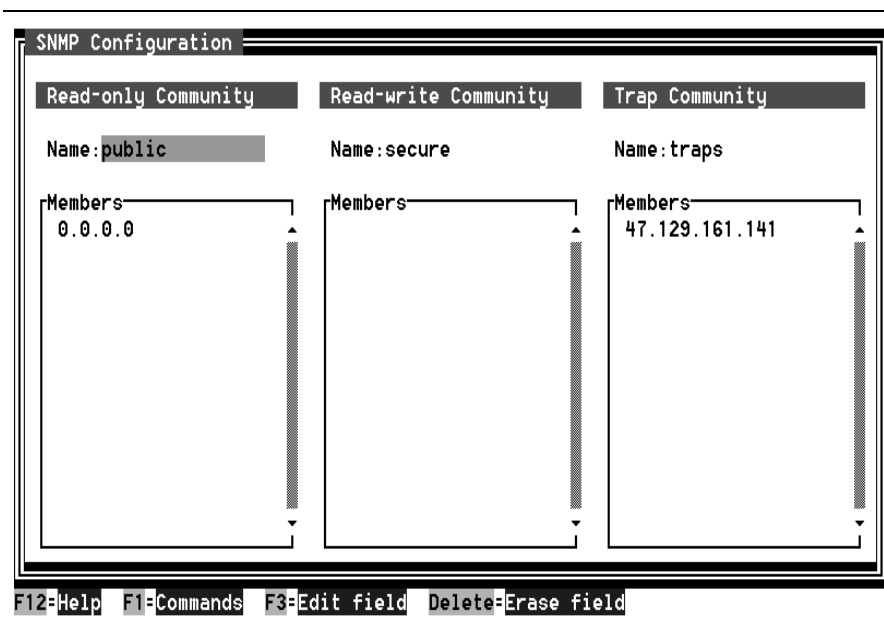

### Field descriptions

The SNMP configuration screen fields are described in the table below.

**Table 6-2: SNMP field descriptions**

Field	Description
Community	<p>The communities are as follows:</p> <p>Read-only - Lists the IP addresses of SNMP managers who may query MIB variables.</p> <p>Read-write - Lists the IP addresses of SNMP managers who may both query and set MIB variables.</p> <p>Trap - Lists the IP addresses of SNMP managers who are to receive traps generated by the system MIBs.</p>
Name	<p>This name can be 1 to 15 characters in length. Any character except the vertical bar can be used. The Read-only and Read-write communities can have the same name, However it is not recommended. When they both have the same name, the Read-write community member list is searched first.</p>
Members	<p>This area lists the IP addresses of SNMP managers that have access to the community. An entry of 0.0.0.0 is used to indicate that all SNMP managers are considered part of that community.</p> <p>Note: The 0.0.0.0 cannot be used in the Trap community because CC MIS needs an explicit list to which traps are to be sent.</p>

**Guidelines**

Perform the steps below to access the SNMP Configuration screen.

**Step 6-6: Accessing the SNMP Configuration screen**

1. Access the Maintenance and Administration menu.
2. Select Configuration to access the Configuration main menu.  

The system displays the Configuration main menu.
3. Select SNMP Configuration to access the SNMP Configuration screen.

## System configuration reports

System configuration reports provide a record of system configuration changes and setup. The system configuration reports are accessed through the Maintenance interface by selecting the Reports option from the Configuration menu.



You must have a maintenance printer defined to print system configuration reports.

The following system configuration reports are available:

- System Configuration Report
- Port Allocation Report
- Switch Link Configuration Report
- Partition Configuration Report
- Disk Allocation Report
- Connection Parameters Report
- Partition Options Report
- Static LAN Terminals Configuration Report
- Serial Terminals Configuration Report
- Printer Configuration Report
- Wallboard Configuration Report
- Storage Parameters Report
- Interval Configuration Report
- Simulator Configuration Report
- SNMP Configuration Report
- Master Privilege Override
- Master Privilege Definition
- All Reports

Examples of these reports are shown in Appendix E.



## Section 7: Partitions (local)



*Note: Refer to Section 8 for information on Networked CC MIS.*

- |   |  |  |
|---|--|--|
| <i>Partition configuration</i>                  | <i>Storage calculator and viewing parameters</i> | <i>Master Privilege Definition</i>               |
| <i>Requirements for a running state</i>         | <i>Connection parameters</i>                     | <i>Partition startup and shutdown</i>            |
| <i>Adding, deleting, and moving a partition</i> | <i>Partition options</i>                         | <i>Data export file (setup to receive files)</i> |

### Regarding Networked CC MIS

Use the information in Section 8 to setup the network and establish network access partitions (NAPs).

*Note:* The Physical Network Configuration option is only displayed on a networked node.

### Introduction

CC MIS Release 5.x allows a CC MIS system to have up to multiple partitions. To run Release 5.x in the same way that 2.x was run, set the number of allowable partitions to one. The partitions described in this section are referred to as local partitions since they reside on the physical VME host and store data for the CC MIS running on that partition.

Multiple partitions allow you to have partitions running in different modes. One partition can be in product mode, while another can be running in training mode. Converting a partition from one mode to another does not affect other partitions. The partition configuration screen is accessed from the Configuration menu shown in Figure 7-1.

Figure 7.1 Configuration menu

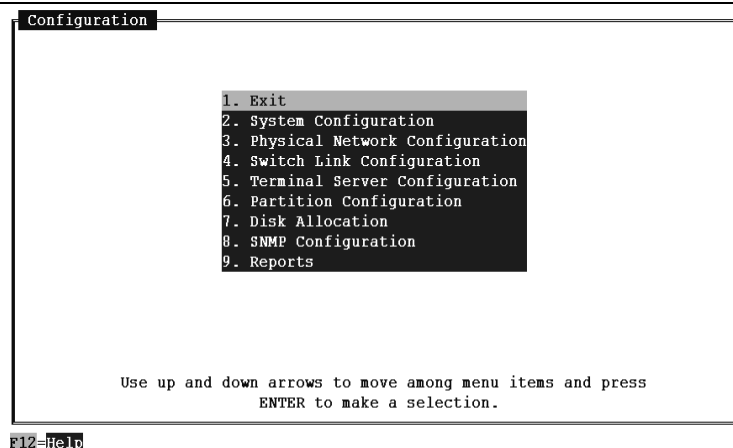

To set up a partition, you first configure the system and define a simulator or live link (refer to Chapter 6), add a partition, set a size limit and disk number (Disk Allocation), set data storage parameters (Storage Calculator) and select a link number, subpool name, and password (Connection Parameters).

The functions that are accessed through the Partition Configuration screen include:

- adding and deleting a partition
- partition options
- disk allocation
- storage calculator
- configuring a serial terminals
- configuring printers
- configuring wallboards
- configuring LAN terminals
- setting master privilege level and overrides

The partition configuration screen is shown in Figure 7-2.

Figure 7.2 Partition Configuration screen

Partition Configuration					
PARTITION NAME	MODE	STATE	PTN ID	DISK	SWITCH LINK NUMBER/TYPE/POOL
Sanity NAP	Product	Running	1	1	(NAP)
Sanity2	Product	Running	3	1	1 - Live - ACDPOOL1

F12=Help   F1=Exit   F3=Edit field   F4=Configuration Options   F9=>>

Press the F9 function key to view the Add Partition, Delete Partition, and Validate Partition commands.

F5=Add Partition   F6=Delete Partition   F7=Validate Partition

### Operating modes

Partitions are in one of four modes: setup, training, precut, or product. The two states are running and stopped. The default mode and state of a newly added partition is setup and stopped, respectively. Partitions in setup cannot be running.



The mode of a partition can be changed by selecting a new mode from the menu on the Mode field. Changes can be initiated when the partition is in either a running or stopped state. Partitions in a stopped state can be changed from one mode to another mode with no additional datafill or other changes required. If the mode is changed while the partition is running, the partition is stopped and an attempt is made to start the partition in the new mode.



Changing the mode of a partition may also involve changes to either the data or definitions database.

### Requirements for a running state

The following list describes the requirements to have a running partition in any of the three available modes (training, precut, or product):

- Partition options must be defined.
- A valid disk for partition data storage must be selected in the Disk Allocation screen.
- Data storage parameters (for example, number of groups, positions, storage durations) must be set in the Storage Calculator screen.



If historical data is not to be collected and stored, enter zero values on the Storage Calculator screen.

- A valid switch link must be selected in the Connection Parameters screen. For the Training mode, only the simulator type can be selected. For the product mode, only live links can be selected.

### Partition configuration commands

The following commands are available using the function key:

**Table 7-1: Partition configuration function commands**

Command	Function
Exit	Exits the current screen.
Configuration Options	Displays a menu list for accessing other functions such as partition options, disk allocation, etc.

**Table 7-1: Partition configuration function commands**

Command	Function
F9=>>>	Displays the Add Partition, Delete Partition, and Validate Parathion commands.
Add Partition	Displays a pop-up area to specify the name of the partition to be added.
Delete Partition	Deletes the partition and all of its associated resources from the system.
Validate Partition	Displays a message in the lower portion of the screen indicating whether the partition is valid for the current mode/state.

**Partition configuration options**

The following options are available using the Configuration Options soft key. These must be completed in the order listed below:

**Table 7-2: Partition configuration options**

Option	Function
Connection Parameters	Displays the Connection Parameters screen.
Partition Options	Displays the Partition Options screen.
Disk Allocation	Displays the Disk Allocation screen.
Storage Calculator	Displays the Storage Calculator screen.
Serial Terminals	Displays the Serial Terminals Configuration screen.
LAN Terminals	Displays the LAN Terminals screen.
Printers	Displays Printer setup screen.
Wallboards	Displays the Wallboard setup screen.
Master Privilege Definition	Displays the Master Privilege Definition screen.

## Adding a Partition

Partitions must be defined using the Partition Configuration screen. Partition names can be up to 16 characters in length.

The initial settings for a new partition are Mode=Setup and State=Stopped.

### Guidelines

Perform the steps below to access the Partition Configuration menu and add a partition.

## Step 7-1: Adding a partition

1. Access the Maintenance and Administration menu.
2. Enter Configuration to access the Configuration main menu.  
  
The system displays the Configuration main menu.
3. Select Partition Configuration to access the Partition Configuration screen.
4. Select Add Partition function key.
5. Enter name for partition to be added (up to 16 characters).
6. Press the Configuration Options function key to access the Configuration Options menu.

## Deleting a Partition

Perform the steps below to access the Partition Configuration menu and delete a partition.

### Step 7-2: Deleting a partition

1. Access the Maintenance and Administration menu.
2. Enter c to access the Configuration main menu.  
  
The system displays the Configuration main menu.
3. Select Partition Configuration to access the Partition Configuration screen.
4. Select the partition to delete.
5. Confirm the deletion in the dialog box that appears.
6. The partition is deleted and the system resources used by that partition are freed.

## Partition options

The Partition Options screen is used to specify a subset of capabilities for use by a single partition. For changes to take effective immediately, the partition must be shutdown and restarted. (Exceptions to this include changes to: Nightly Backup, Max Supervisor Connections, and Maximum Logins.)



The values in the brackets [ ] next to maximum fields indicates the range of available resources, which is calculated by system wide limits minus the resources already in use by other partitions.

Therefore, the valid range for any field with numerical value is the system limits defined in the option of the distribution tape minus the sum of all the other partitions' values. The values of each field for all partitions are added together and compared to the system limit.

Figure 7.3 Partition options screen

```

Partition Options - First
|
| Data Export : Enabled
| Language Support : Enabled
| Use of Maintenance Printer : Enabled
| Nightly Backups : Definitions Only
| Automatic Position Reassignment : Enabled
| SNMP Support : Disabled
| Flexible Intervals : Enabled
| Maximum ACD Groups [1-663] : 40
| Maximum Positions [1-2732] : 200
| Maximum Wallboard Chains [0-47] : 4
| Maximum Supervisor Connections [0-487]: 4
| Maximum Logins [0-39] : 4
|
| Custom Time Zone Specification : EST5EDT
|
| Dynamic LAN Terminal Access : Enabled
| Access Password : misrus
|
|-----|
F12=Help F1=Commands F2=Options

```

The table below describes the fields of the Partition Options screen.

**Table 7-3: Partition options screen fields**

Parameter	Description
Data Export	Enables or disables the ability for the partition to use the CC MIS Data Export feature.
Language Support	Enables or disables the ability for the partition to make use of multiple languages.
Use of Maintenance Printer	Enables or disables the ability for the partition to use the system maintenance printer for printing the partition's reports.
Nightly Backups	<p>Configures automated nightly backups for this partition.</p> <p><i>Disabled</i> - No nightly backups performed for this partition.</p> <p><i>Enabled</i> - All partition data is backed up.</p> <p><i>Definitions Only</i> - Only the partition's definitions database is backed up. This is useful when data database is very large and is already protected by a RAID device. Backing up definitions allows for recovery from accidental deletion of definitions.</p> <p><i>Data Only</i> - Only the partition's historical data database is backed up.</p>
Automatic Position Reassignment	Enables or disables the ability for the agents associated with this partition to be automatically reassigned to specified groups based upon their login ids.
SNMP Support	<p>Enables or disables the SNMP feature for the selected partition.</p> <p><i>Note:</i> Optional feature.</p>
Maximum ACD Groups	Maximum number of ACD groups the partition may datafill in the Storage Calculator.
Flexible Intervals	Enables or disables flexible intervals for the partition.
Maximum Positions	Maximum number of agent positions the partition may datafill in the Storage Calculator.
Maximum Wallboard Ports	Maximum number of wallboard ports the partition may use. A zero value indicates that the Wallboard option is not enabled.

**Table 7-3: Partition options screen fields**

Parameter	Description
Maximum Supervisor Connections	Maximum number of connections, including both hard-wired and LAN, that this partition can have at one time. This information is used to limit the number of running processes on the system. This field must be greater than or equal to the Maximum Logins field.
Maximum Logins	Maximum number of supervisors that can be logged in to the system for the partition at a given time. This field must be less than or equal to the Maximum Supervisor Connections field.

**Table 7-3: Partition options screen fields**

Parameter	Description
<p>Custom Time Zone Specification</p>	<p>Allows a partition to be set to run in a different time zone than the rest of the system. Leave this field blank if the system's time zone setting is appropriate for the partition. If specified, the custom timezone setting should be specified in one of two formats depending on whether or not the time zone uses daylight savings time.</p> <p>Time zones without Daylight Savings Time:</p> <p>STD offset</p> <p>The STD string specifies the name of the time zone and must be three or more alphabetic characters. The offset string immediately follows STD and specifies the time value to be added to the local time to get Coordinated Universal Time (UTC). The offset is positive if the local time zone is west of the Prime Meridian and negative if it is east. The hour must be between 0 and 24, and the minutes and seconds 0 and 59.</p> <p>Time zones with Daylight Savings Time:</p> <p>STDoffsetDST[offset][,start[/time],end[/time]]</p> <p>There are no spaces in the specification. The initial STD and offset specify the standard time zone, as described above. The DST string and offset specify the name and offset for the corresponding daylight savings time zone. If the offset is omitted, it defaults to one hour ahead of standard time.</p> <p>The start field specifies when daylight savings time goes into effect and the end field specifies when the change is made back to standard time. These fields may have the following formats:</p> <p>Jn This specifies the Julian day with n between 1 and 365. February 29 is never counted even in leap years.</p> <p>n This specifies the Julian day with n between 1 and 365. February 29 is counted in leap years.</p> <p>Mm.w.d This specifies day d (0 &lt;= d &lt;= 6) of week w (1 &lt;= w &lt;= 5) of month m (1 &lt;= m &lt;= 12). Week 1 is the first week in which day d occurs and week 5 is the last week in which day d occurs.</p> <p>Day 0 is a Sunday.</p> <p>The time fields specify when, in the local time currently in effect, the change to the other time occurs. If omitted, the default is 02:00:00.</p>



**Table 7-3: Partition options screen fields**

Parameter	Description
Dynamic LAN Terminal Access	Allows Supervisor terminals in the Windows Interface to connect to a specified partition without the IP Address being defined in the Static LAN Terminals screen. When enabled, the partition can be accessed by any client PC provided the user knows the name of the partition and the partition's Access Password. Enabling this option allows client PCs which are assigned a random IP address by a DHCP server to access the partition without constantly changing the IP address assignment for the PC in the Static LAN Terminals screen.
Access Password	this field is used to set the access password for this partition. This password is required when the Dynamic LAN Terminal Access is enabled. Note that this password is case-sensitive. A change to this option or its associated password will take effect immediately, and does not require that the partition be shut-down and restarted.

## Guidelines

Perform the steps below to access the Partition Options screen.

### Step 7-3: Accessing the Partition Options screen

1. Access the Maintenance and Administration menu.
2. Enter c to access the Configuration main menu.

The system displays the Configuration main menu.

3. Select Partition Configuration to access the Partition Configuration screen.
4. Press the Configuration Options function key to display Configuration Options menu.
5. Select Partition Options from the Configuration Options menu.

The system displays the Partition Options screen.

## Disk Allocation

Partition data must reside on one disk. However, a disk may contain several partitions. Therefore, resource limits must be set for each partition. The Disk Allocation screen allows you to assign a disk to a partition.

In addition, you may enter the storage calculator to compute the appropriate size limit for a partition or change the size limit for a partition. The Disk Allocation screen is available from the main menu, as well as being available from the Configuration Options key inside the Partition Configuration screen.

When a partition is being moved to a new disk, the Partition Moving: prompt is displayed on the upper portion of the screen along with the ID of the partition being moved.

Figure 7.4 Disk Allocation screen

Disk Allocation					
Partition Name	Size Limit	Space In Use	% In Use	Disk No.	% Disk Alloc
Steve	450M	95M	21	1	40
Dave	70M	63M	90	2	7
Abbey	75M	54M	72	1	6
Mickey	75M	57M	76	2	8
Feng	90M	59M	65	2	9
Ruben	200M	63M	31	1	17
Bryan	100M	53M	53	2	10
John 1	60M	57M	95	2	6

Disk Usage Statistics					
Disk No.	Mount Directory	Disk Size	Avail Space	%Full	Num Partitions
1	/misdata/disk1	1125M	325M	71	4
2	/misdata/disk2	933M	378M	59	7

F12=Help F1=Exit F4=Storage Calculator F5=Switch to disk section

**Automated Calculations**

Starting in Release 4.1, an Analyze Configuration function key was added to the Storage Calculator screen. Pressing this function key allows the storage calculator to analyze the values for your system based on data received from the switch and your system configuration.

```

Analysis of the ACD configuration for this partition has computed
values for the following parameters:

PARAMETER          VALUE
Number of ACD groups..... 10
Avg source ACD-IMS/group..... 51
Avg active positions..... 100
Avg source groups/dest group.. 3

These values assume that all overflow combinations found in the
configuration will occur during daily operation but do NOT take
into account any call transfers that may occur. The source/dest
combination values should be adjusted upward if there are a
significant number of calls transferred that would cause additional
source/dest combinations to be created.

All configured positions are assumed to be active positions.

Would you like to use these computed values?
    
```

**Guidelines**

Perform the steps below to assign a disk or move a partition from one disk to another.

**Step 7-4: Assigning a disk**

1. In the Disk allocation screen, cursor to the Disk No field.
2. Enter the disk number on which the partition is to reside.

Note: Select a disk that has enough space. Check the Disk Usage field to see which disk has adequate space.

The table below defines the parameters and gives their limits.:

**Table 7-4: Disk allocation screen parameters**

Option	Defines
Partition Name	The name of the partition as defined in the Partition Configuration screen.
Size Limit	The maximum space (in megabytes) allocated for storage of the partition's data. This field can be changed on this screen or using the storage calculator.
Space In Use	The number of megabytes of the partitions' allocated space that is currently in use by partition.
% In Use	The percentage of the partitions' allocated space that is currently in use. Computed as follows: Space In Use / Size Limit x 100.
Disk No.	The disk number on which the partition's data resides. This field is used to move a partition to a new disk.
% Disk Alloc	The portion of the entire disk that is allocated to the partition. Computed as follows: Size Limit / Disk Size x 100.

**Table 7-4: Disk allocation screen parameters**

Option	Defines
Disk Usage Area	<p>This area indicates the sizes of the disk and the amount of available space for each disk.</p> <p>The fields for this area are described below.</p>
Mount Directory	The directory where the physical device is mounted.
Disk Size	The sum of all allocated partitions on a disk plus the remaining space available for allocation in megabytes.
Available Space	The Disk Size minus the sum of all allocated partitions of the disk.
%Full	The percentage of the total disk size that is allocated.
Num Partitions	The number of partitions that are set up on this disk.

## Storage calculator

The Storage Calculator screen can be accessed using the soft key on the Disk Allocation screen or from the Configuration Options menu in the Partition Configuration screen. The Storage Calculator screen allows you to view or modify the data storage parameters of the historical database for a selected partition.

Figure 7.5 Storage calculator screen

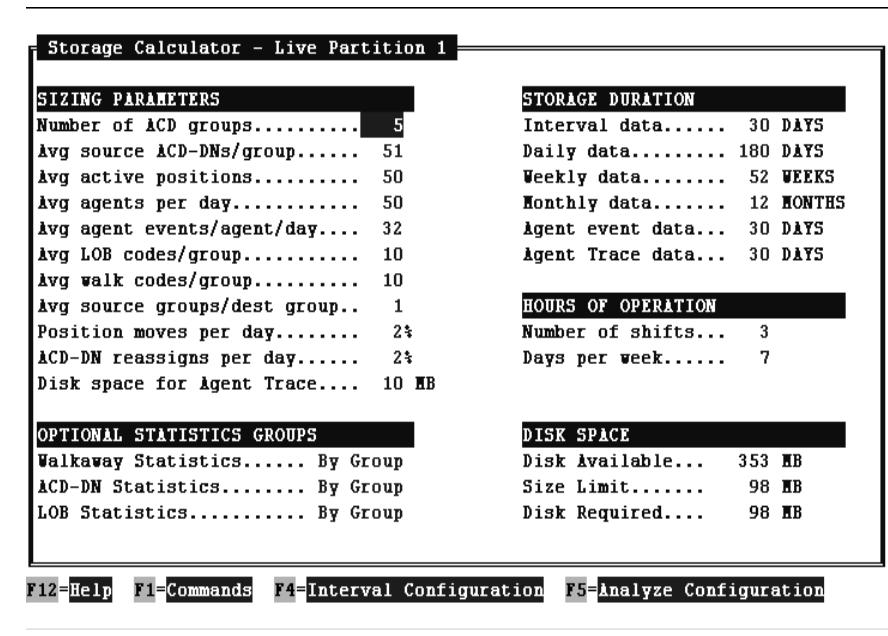

### Guidelines

Perform the steps below to review the database parameters.

## Step 7-5: Reviewing database parameters

1. Access the Configuration menu.
2. Select the Disk Allocation option.
3. From the Disk Allocation screen, select the Storage Calculator function key.
4. The system displays the Storage Calculator screen. Review the parameters.
5. Press the Commands key and select Exit to return to the Configuration menu.

## Changing data storage parameters

The Storage Calculator allows you to change data storage parameters. After you adjust the parameters, the system calculates if there is enough disk space in the partition for the database you defined before the database is reconfigured. The system does not let you save the results of this customization process unless the parameters configured are allowed by the amount of space available.

After these values are entered and accepted, the historical database is built or reconfigured based on the given values for the partition. The system ensures that the database configuration values are not exceeded for the number of ACD groups, definable agents, and active agents. When these values are exceeded, the system generates a warning log message and continues to store data in the database and removes oldest data from the database.

Refer to Table 2-1 for data storage parameters and their limits.

### Guidelines

Perform the steps below to change the size of the database.

## Step 7-6: Changing data storage parameters

1. Access the Configuration menu.
2. Select the Partition Configuration command.

*Note:* The Storage Calculator can also be accessed by selecting Disk Allocation, then pressing the soft-key for Storage Calculator.

3. From the Partition Configuration screen, press the Configuration Options function key and select Storage Calculator.

The system displays the Storage Calculator screen.

4. Change the desired Data Storage parameters.
5. Use the Commands key to save and exit or to exit without saving.

You can allow the system to calculate your data storage parameters by pressing the Analyze Configuration function key. The system will display recommended values based on data received from the switch and on your system's configuration.

## Interval Configuration

The Interval Configuration screen is used to customize the intervals used for each hour of the day. The Interval Configuration screen is accessed from the Storage Calculator screen (for local partitions) and from the Partition Options menu (on NAPs). The Interval Configuration screen is shown in the figure below.

Figure 7.6 Interval Configuration screen

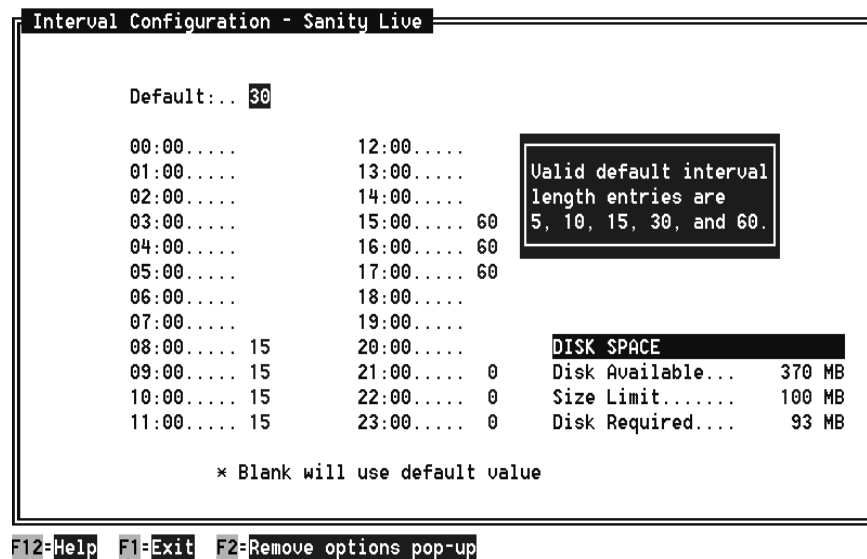

Valid default values are 5, 10, 15, 30, and 60 minutes.

Valid interval lengths are 0, 5, 10, 15, 30, and 60. Leave the field blank if you want to use the default setting.

**Note:** The size limit field is editable in this screen.

### Issues Concerning Interval Lengths

1. If you are using the Networking feature, you should try to use the same interval lengths on each partition. This allows for more concise data reporting when requesting interval-based reports.
2. Using more frequent intervals (5, 10, and 15) will require more storage disk space. Ensure that your system has adequate disk space to store the requested interval data. Insufficient disk spaces results in some data being discarded.



## Connection parameters

The Connection Parameters screen, as shown in Figure 7-5, is used to enter information relating to a partition's connection to a switch or the internal simulator.

Figure 7.7 Connection Parameters screen

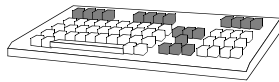

*Note:* The <Return> key is the same as the <Enter> key on the keyboard.

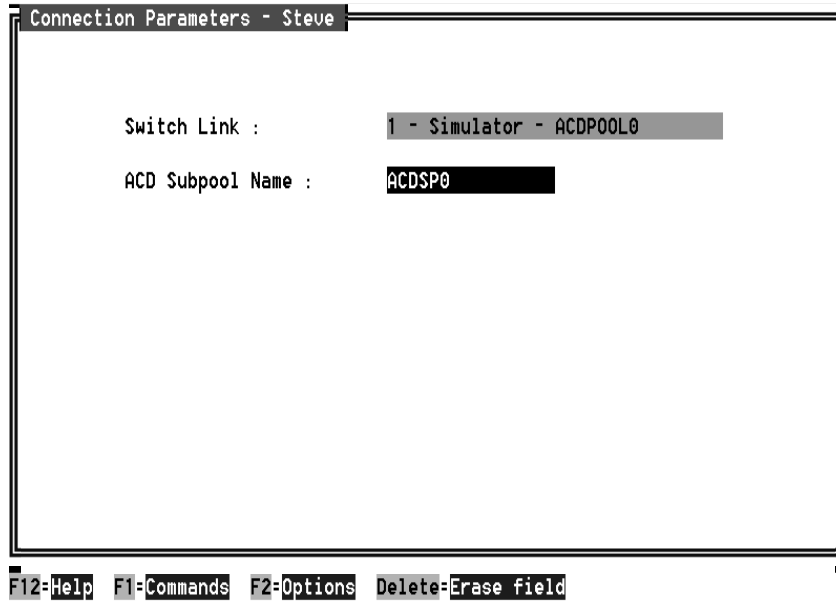

The table below describes the fields of the Connection Parameters screen.

Table 7-5: Connection parameter screen fields

Parameter	Description
Switch Link Number	Value is selected from a list of defined links. This field determines the ACD pool or simulator to which the partition is connected.
ACD Subpool Name	Selection from a list or manual entry is allowed in this field.
ACD Subpool Password	Administrator provides password for live links. (This field is not displayed for a simulator link.)

## Guidelines

Perform the steps below to access the Connection Parameters screen.

### Step 7-7: Accessing the Connection Parameters screen

1. Access the Maintenance and Administration menu.
2. Enter *c* to access the Configuration main menu.  
  
The system displays the Configuration main menu.
3. Select Partition Configuration to access the Partition Configuration screen.
4. Press the Configuration Options function key to display Configuration Options menu.
5. Select Connection Parameters from the Configuration Options menu.

The system displays the Connection Parameters screen.

---

On PowerPC there are only “Unix” and “PC” connectivity options. Printers directly connected to the host must be configured into Unix before they can be used by CC MIS.

---

## Serial Terminals

The Serial Terminals screen allows terminals to be added, deleted, or modified for a partition in the CC MIS system.



A supervisor may add, change, or delete terminals while the CC MIS software is running.

Figure 7.8 Serial terminals screen

### PC-attached Printers

**Note:** PC-attached printers can only be added through the Report Services command in the Supervisor Interface.

Serial Terminals - SP1			
PORT	CONNECTIVITY		COMMENT
m337_c0d30	Direct	9600	Test3forDemetria

F12=Help F1=Commands F2=Options F5=Add F6=Delete

### Add, Delete, or Change

Use the Add or delete function keys to add or remove a serial terminal. To change a value in one of the fields, highlight the value and press the Options function key. When applicable, select the desired value from the Options popup menu.

## Guidelines

Perform the steps below to add a serial terminal.

### Step 7-8: Adding a serial terminal

1. Access the Partition Configuration screen.
2. Press the Configuration Options function key, then select the Serial Terminals option on the menu to access the Serial Terminals screen.

The Serial Terminals screen is displayed.

3. To add a new serial terminal, select the Add function key. Select the desired terminal and press <Return>. The new selection is added to the screen.
4. To change the connection:
  - a. Highlight the connection to be changed.
  - b. Press the Options function key.
  - c. Select Direct or Modem from the menu and press the <Return> key.
5. To change the baud rate:
  - a. Highlight the baud to be changed.
  - b. Press the Options function key.
  - c. Select the desired baud rate from the menu and press the <Return> key.
6. To add comments:
  - a. Highlight the Comments field.
  - b. Type desired comment.
7. Save the configuration by selecting Save and Exit from the Commands menu on the screen

## Printers

This command allows you to add a printer directly connected to the CC MIS system. When you add a printer, you assign a name to it. This name designates the physical printer to which reports are sent for printing. The types of printers for the CC MIS system are

- Direct printers (those attached directly to a CC MIS port)
- PC-attached printers (directly attached to the supervisor's PCs)

### Constraints

The Connectivity field of the Printer Configuration screen, as shown in the figure below, informs you of the way the printer is connected - either Direct or PC. The system supplies this information when a printer is attached. You cannot change this field on a PC-attached printer.

Figure 7.9 Printer Configuration screen

Printers - SP1			
INTERFACE	CONNECTIVITY	PRINTER MODEL	PRINTER NAME
47.81.160.107	PC		GRE-D2 ON SPIN

F12=Help F1=Commands F5=Add

For printers connected to a remote PC that are attached to the host by a LAN connection, the port number is an IP address in Internet dotted format.

You cannot use this procedure to add a PC-attached printer. To add a printer to a Supervisor PC, configure the printer locally on the PC itself using the Session/Setup/Report Services option. This adds the printer to the PC. You also cannot use this procedure to set the customer default printers. The customer default printers are set using the Supervisor interface Customer Options.

*Note:* PC-attached wallboards are allowed in Release 4.

## Guidelines

Perform the steps below to add a printer.

### Step 7-9: Adding a printer

1. Access the Partition Configuration screen.
2. Press the Configuration Options function key, then select the Printers menu option to access the Printers screen.  
  
The Printer screen is displayed.
3. To add a printer, perform the following steps:
  - a. Press the Add function key and select an option.
  - b. To change an option in the Connectivity fields, highlight the option then press the Options function key and select the desired item from the menu.
  - c. To select a printer, highlight the Printer Model field, then press the Options function key. Select the desired printer from the menu and press <Return>.
  - d. At the Printer Name field, enter a unique printer name.
4. Save the configuration by selecting Save and Exit from the Commands menu on the screen

## Changing a printer definition

You can change a printer connected to the CC MIS system. For printers connected to a remote PC attached to the host by a LAN connection, the port number is an IP address in Internet dotted format.

You can only use this procedure to change the model or name of a printer that is directly attached to the CC MIS system. The Connectivity field indicates how the printers are attached—either Direct or PC attached. You cannot change this field. The system supplies this information when a printer is attached.

### Guidelines

Perform the steps below to change the printer definition.

## Step 7-10: Changing a printer definition

1. Access the Partition Configuration screen.
2. Press the Configuration Options function key, then select Printers in the menu to access the Printers screen.

The Printer screen is displayed. Listed on the screen are all printers currently configured.



#### Print jobs are suspended or discarded

Changing a printer definition can cause current print jobs to be stopped and reprinted in their entirety after reconfiguration is complete. Pending jobs are discarded when printers are removed.

3. To change a printer definition, perform the following steps.
  - a. Highlight the Printer Model field of the entry to be changed.
  - b. Press Options.
  - c. Highlight your selection on the menu and press <Return>.
 

The cursor moves to the Printer Name field.
  - d. At the Printer Name field, enter a unique printer name.
  - e. Repeat this step for all printers to be changed.
4. Select Exit to exit and return to the Port Configuration screen.
5. Save the configuration by selecting Save and Exit from the Commands menu on the screen.

### Descriptions in Online Help

Refer to the online help (accessed by pressing the Help function key) for detailed explanation of each field and acceptable values.

## Removing a printer from the system

This command allows you to delete printers (directly connected only) from the system.

### Guidelines

Perform the steps below to remove a printer from the system.

## Step 7-11: Removing a printer definition

1. Access the Printers screen.
2. Place cursor on device type.
3. Press the Delete function key.



### Print jobs are discarded!

Pending jobs are discarded when printers are removed.

---

4. Save and Exit using the Commands function key.
-



## Wallboards

This command allows you to add a wallboard. Wallboards are used by supervisors to display messages. Three types of wallboards are supported: Nortel, Daktronics, and Generic. When adding wallboards, you can chain multiple wallboards, up to five, together on one port or assign one wallboard to a port.

To add a wallboard, you must know its device number used as the address for the wallboard, a number assigned to it during manufacture. For Daktronics wallboards, to see the address number, unplug the device from power and then plug it in again. The wallboard displays the message Unit OK and the device number. For Nortel wallboards the address is programmed using the remote keypad (a remote control device).

## Constraints

CC MIS supports up to five wallboard devices per port. These devices may be chained together on a common port (a maximum of five wallboards per port) or each wallboard can be configured on its own port. Ports not assigned to supervisor displays or printers can be used as wallboard ports.

Wallboards are optional and may not be available on your system.

Figure 7.10 Wallboard Configuration screen

PORT	CONNECTIVITY	MODEL	ADDRESS	NAME
m337_c0d15	Direct	9600 Daktronics	4343	Dak wallbd
m337_c0d20	Modem	9600 Generic		Wallboard Gen

F12=Help F1=Commands F2=Options F5=Add F6=Delete

## Guidelines

Perform the steps below to add a wallboard.

### Step 7-12: Adding a wallboard

1. Access the Partition Configuration screen.
2. Access Configuration Options, then select Wallboards.
3. On the Wallboards screen, select the Add function key, then select the port for the wallboard.
4. Edit the settings in each field, as desired, by highlighting the field and pressing the Options function key. The Options menu with valid options for that field is displayed. (Items A and B are not displayed for terminal server ports.)
  - a. Select connectivity type: (Direct or Modem)
  - b. Select a baud rate from the menu.
  - c. Enter the address for the wallboard:  
Daktronics - a six digit number (supplied in the wallboard)  
Nortel - two digit number (01 - 99 set by remote).  
Generic - not meaningful and is automatically set to 1 by the system.
  - d. Press the Edit Field function key and enter name in the Name field.  
Press End Editing after name has been entered.
5. Save the configuration by selecting Save and Exit from the Commands menu on the screen.

### Changing a wallboard's configuration

You can change a wallboard's configuration or rename a wallboard. Use the steps above to access the Wallboard screen, then edit the configuration using the Options and Edit Field function keys, as applicable.



To move a wallboard from one port to another, remove the current definition of the wallboard; then add the wallboard definition at the other port using the steps listed above.

Only one type of wallboard can be used on a port. A total of five wallboards per port are supported. (Only one generic wallboard per port is supported.)

### Removing a wallboard from the system

The Delete function key is used to remove a wallboard from the system.

## LAN Terminals

Each partition can have a set of datafilled LAN IP addresses that are connected as supervisor stations for that partition. These IP addresses are entered using the LAN Terminals screen.

Figure 7.11 LAN Terminals screen (with add text)

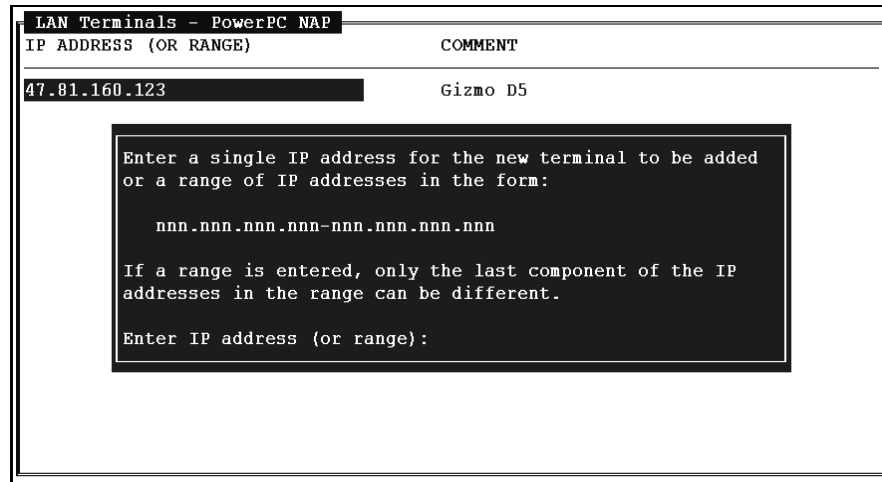

The following limitations apply to the LAN Terminals screen:

- Two partitions cannot share the same IP address.
- There is no limit to the number of LAN terminal IP addresses that can be defined in this screen. However, the number of active terminals is limited at run time by the "Max Supervisor Connection" parameter.

Perform the steps below to access the LAN Terminals screen to add LAN clients.

### Step 7-13: Accessing LAN terminals

1. Access the Maintenance and Administration menu.
2. Enter *c* to access the Configuration main menu. The system displays the Configuration main menu.
3. Select Partition Configuration to access the Partition Configuration screen.
4. Press the Configuration Options function key to display Configuration Options menu for a particular partition.
5. Select LAN Terminals from the Configuration Options menu. The system displays the LAN Terminals screen.

**Note:** Global views and monitor privileges can be Yes only if Displays is set to Yes.

If Displays is set to No, then the other two fields are set to No.

## Adding LAN Terminals

Perform the steps below to add a LAN terminals.

### Step 7-14: Adding LAN terminals

1. Access the Partition Configuration screen.
2. Press the Configuration Options function key to display Configuration Options menu.
3. Select LAN Terminals from the Configuration Options menu.  
  
The system displays the LAN Terminals screen.
4. Press the Add function key.
5. Enter the Ip address or range of IP addresses (refer to format shown on add screen for entering ranges).

## Deleting LAN Terminals

Perform the steps below to delete LAN terminals.

### Step 7-15: Deleting LAN terminals

1. Access the Partition Configuration screen.
2. Press the Configuration Options function key to display Configuration Options menu.
3. Select LAN Terminals from the Configuration Options menu.  
  
The system displays the LAN Terminals screen.
4. Highlight the LAN terminal to be deleted, then press the Delete function key.
5. Select the Save & Exit option from the Commands menu.

*Note:* At least one of either Personal Reports or Public Reports must be set to Yes in order for Global Views and Monitor to be set to Yes.

Otherwise, these fields are set to No.

*Note:* Basic must be set to Yes for any other privilege to be set to Yes.

Otherwise, all are automatically set to No.

## Supervisor Privileges

Supervisors on a partition can make configuration changes to multiple local partitions.

The master supervisor privilege definition is used to disable supervisor privileges on a partition. (The definition's default setting is to enable all privileges.) If a supervisor privilege is disabled in the master privilege definition for the partition, then that privilege will be disabled for all supervisors in that partition. However, individual supervisors can be assigned an override where by their privileges are not restricted by the master privilege definition.

The master privilege definition is comprised of several screens. The first screen is a menu which is accessed from the Configuration Options menu in the Partition Configuration screen. This screen lists selections to set privileges in any of the five privilege areas that make up the master privilege definition and a selection to set supervisor overrides.

### Guidelines

Perform the steps below to access the Master Privilege Definition screen.

**Note:** Partitions must be running to access the Master Privilege screens.

## Step 7-16: Accessing the Master Privilege screen

1. Access the Maintenance and Administration menu.
  2. Enter c to access the Configuration main menu.
- The system displays the Configuration main menu.
3. Press the Configuration Options function key to display Configuration Options menu.
  4. Select Partition Configuration to access the Partition Configuration screen. Highlight the desired partition.
  5. Select Master Privilege Definition from the Configuration Options menu.

The system displays the Partition Options screen.

Selection of an option causes a secondary screen to be displayed. This screen is used to set the appropriate privileges or supervisor overrides. The Master Privilege Definition menu screen is shown in the figure below.

**Note:** if default colors is set to Yes in the Admin Privileges, then it is always set to Yes and cannot be set to No.

Figure 7.12 Master Privilege Definition screen

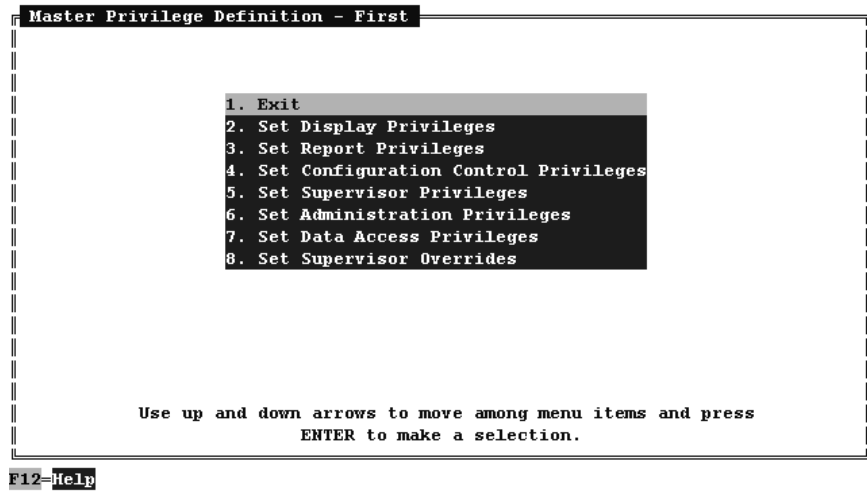

### Display privileges

The Display Privileges screen is shown in the figure below. The commands available in this screen are Exit and Save and Exit.

*Note:* The Alarms privilege is displayed when the SNMP option has been enabled for the partition.

Figure 7.13 Display Privileges screen

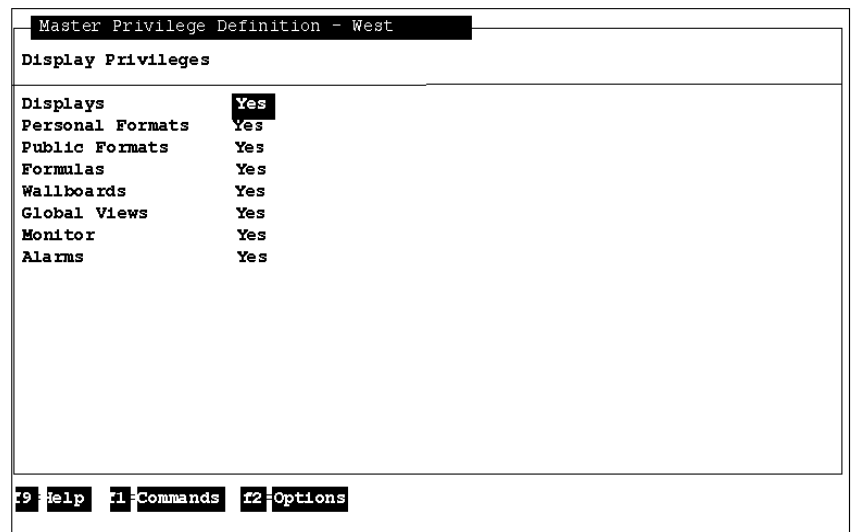

### Report privileges

The Report Privileges screen is shown in the figure below.

Figure 7.14 Report Privileges screen

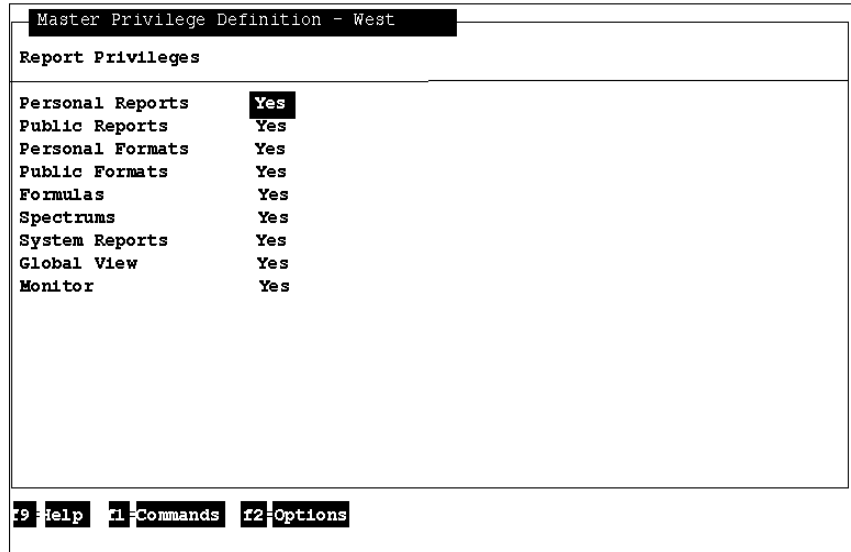

### Configuration control privileges

The Configuration Control Privileges screen is shown in the figure below.

Figure 7.15 Configuration Control Privileges screen

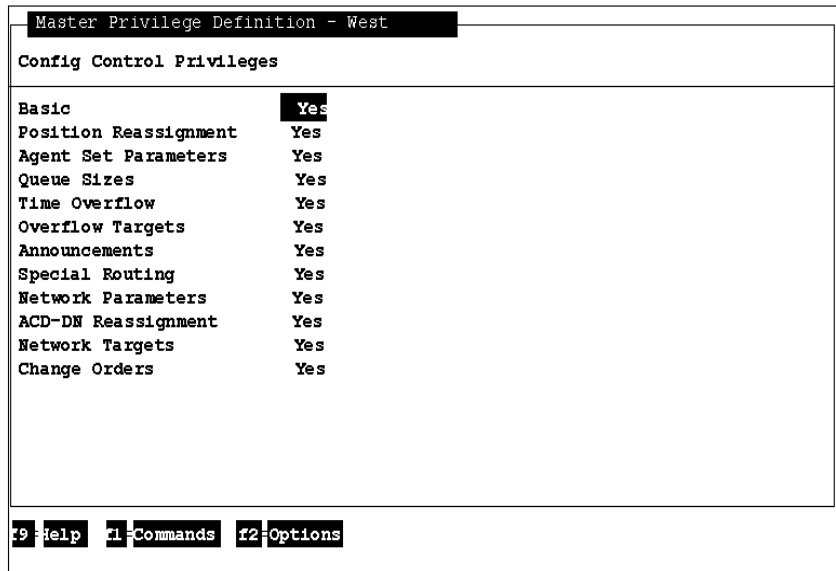

### Supervisor privileges

The Supervisor Privileges screen is shown in the figure below.

Figure 7.16 Supervisor Privileges screen



### Administration privileges

Administrator privileges are enabled using the Administration Privileges screen. The Administration Privileges screen is shown in the figure below.

Figure 7.17 Administration Privileges screen

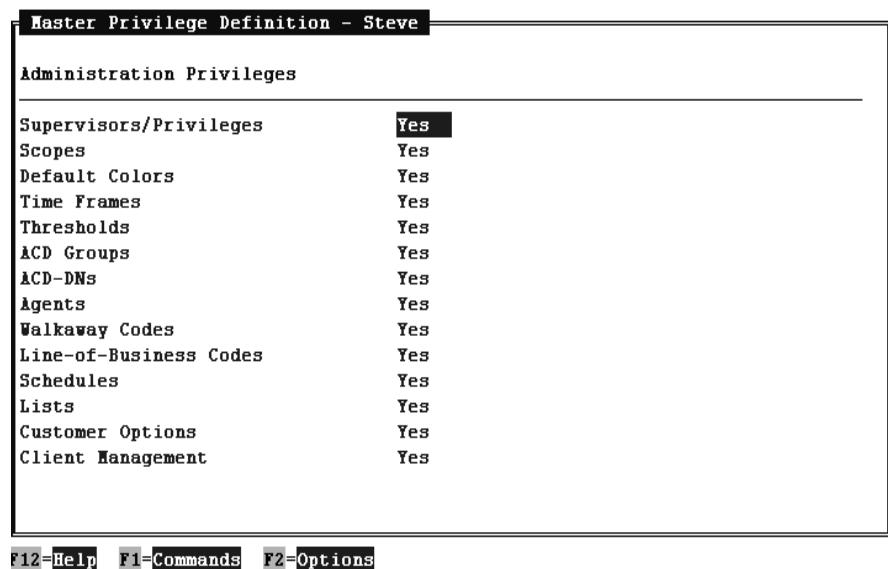



### Data Access Privileges

The Data Access Privilege screen is shown in the figure below.

Figure 7.18 Data Access Privilege screen

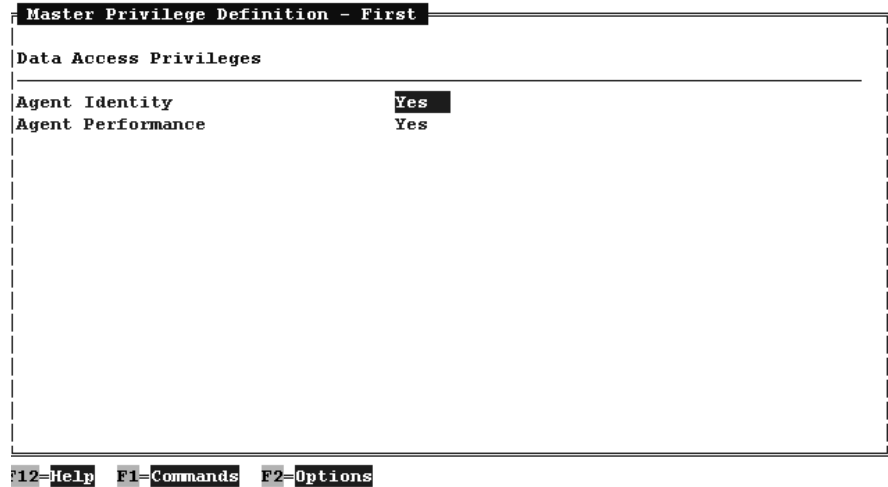

### Supervisor override privileges

Supervisor IDs must first be defined in Supervisor Definition in order for them to appear in this screen. The screen displays all supervisors that are currently defined. Supervisor IDs cannot be added or deleted in this screen. Supervisors can be assigned an override so that their privileges are not restricted by the master privilege definition.

Figure 7.19 Supervisor Override screen

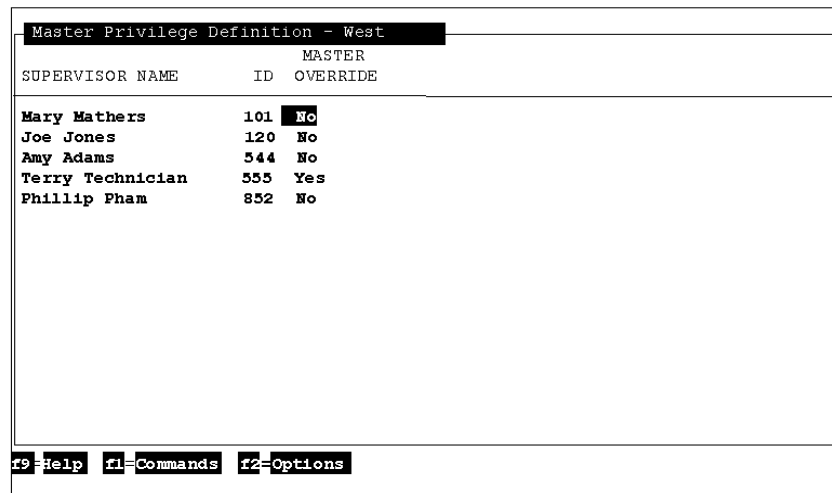

The Supervisor Override field descriptions are listed in the table below.

**Table 7-6: Supervisor Override field descriptions**

Field	Description
Supervisor Name	The name of the supervisor (as defined in the Definitions Database).
ID	The ID of the supervisor (as defined in the Definitions Database).
Master Override	Whether the supervisor has master privileges. The values for this field are:  No            Privileges are restricted by the master privilege definition (default).  Yes            Privileges are not restricted by the master privilege definition.

## Partition Startup/Shutdown

The status of a partition can be changed using the Partition Startup and Shutdown and Partition Configuration screens. These screens allow you to change the state of partition by specifying either Running or Stopped.

The figure below shows the Maintenance and Administration menu.

Figure 7.20 Maintenance and Administration menu

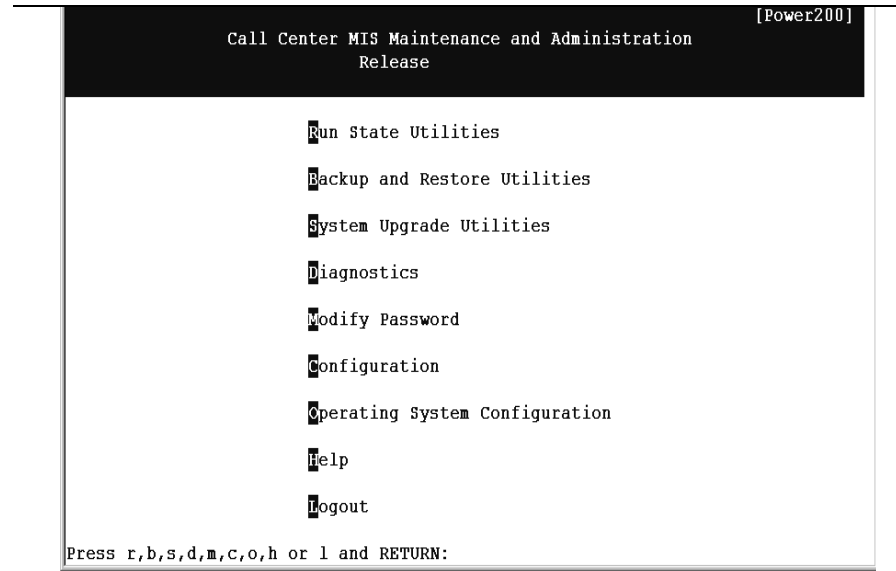

The figure below shows the Run State Utilities screen.

Figure 7.21 Run state utilities screen

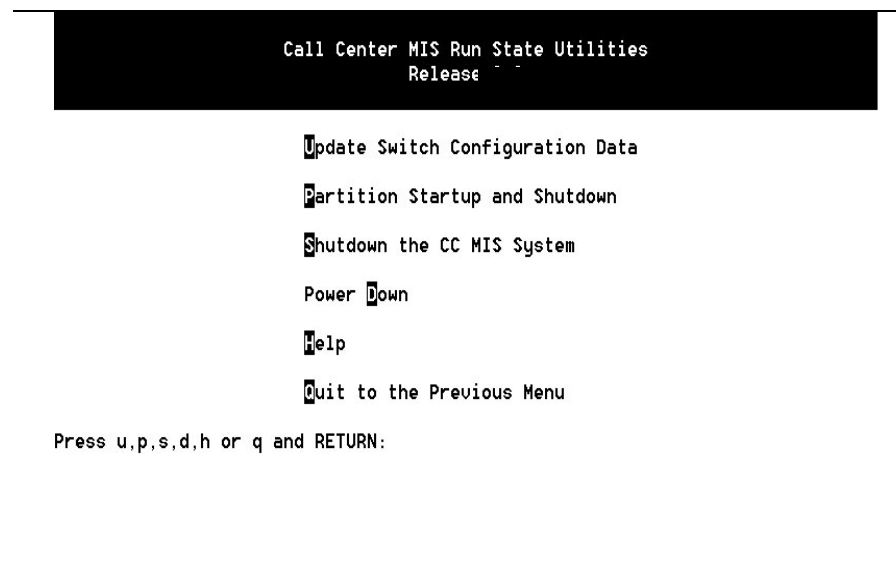

The figure below shows the Partition Startup and Shutdown screen.

Figure 7.22 Partition startup and shutdown screen

Partition Startup and Shutdown			
PARTITION NAME	MODE	STATE	ID
Steve	Training	Running	1
Dave	Training	Running	2
Abbey	Training	Running	3
Mickey	Training	Running	4
Feng	Training	Running	5
Ruben	Training	Running	6
Bryan	Training	Running	7
John 1	Training	Running	8
John 2	Product	Running	9
New	Precut	Running	10
minheng	Product	Running	11

1. Stopped  
2. Running

F12=Help F2=Select no option

### Guidelines

Perform the steps below to access the Partition Startup and Shutdown screen.

## Step 7-17: Accessing Partition Startup and Shutdown screen

1. Access the Maintenance and Administration menu.
2. Enter *r* to access the Run State Utilities menu.  
  
The system displays the Run State Utilities menu.
3. Select Partition Startup and Shutdown to access the Partition Startup and Shutdown screen. Highlight the desired position.
4. Press the Options function key to display Options menu.
5. Select the desired state for the partition from the Commands menu.

*Note:* If CC MIS is running, the system will prompt for confirmation before changing the state of the partition.

## Configuring a PC to receive data export files

Perform the steps below (88K-based platforms only) to set up a PC to receive data export files when the Windows interface is not available.

### Step 7-18: Setting up a PC to receive data export files

1. Define the supervisor terminal in the CC MIS system.
2. On the supervisor PC, select the Session / Setup / Report Services option from the supervisor interface CC MIS Main menu.
3. Select the services to be used under the Services tab, then set up a printer and the print to file function under the Printer tab. (Refer to online Help for field descriptions on the Report Services screen.) The options under the Filing tab are used to specify how files are saved on the computer.
4. After the report services are defined, access the Report Parameters window. In the Contents Style field, select Data Export Report. Then in the Output To field, select the printer defined in step 3. Specify the desired file name.
5. Select the desired settings for other the fields in the Report Parameter screen.
6. After all values are specified, select the Report / Generate option to create the report file.
6. The file is placed in the directory specified in the Report Services screen.



# Section 8: Networked CC MIS

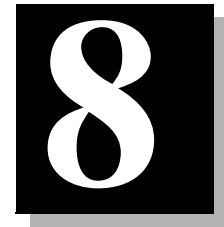

➤ *Overview of a network*

➤ *Physical Network Configuration*

➤ *Virtual Network Configuration*

➤ *Steps for Establishing a Network*

➤ *Switch Link Configuration*

➤ *Master Privilege Definition*

➤ *System Configuration*

➤ *Defining Network Access Partitions*

## Access to Networking

To establish a network, the networking feature must be enabled on your CC MIS system.

## Introduction to Networked CC MIS

This chapter presents information on how to configure components for a CC MIS network.

CC MIS Release 5 allows separate CC MIS systems to be networked. This network allows supervisors to view or consolidate real-time or historical data from one or more partitions in the network. A high-level view of the network feature is illustrated below.

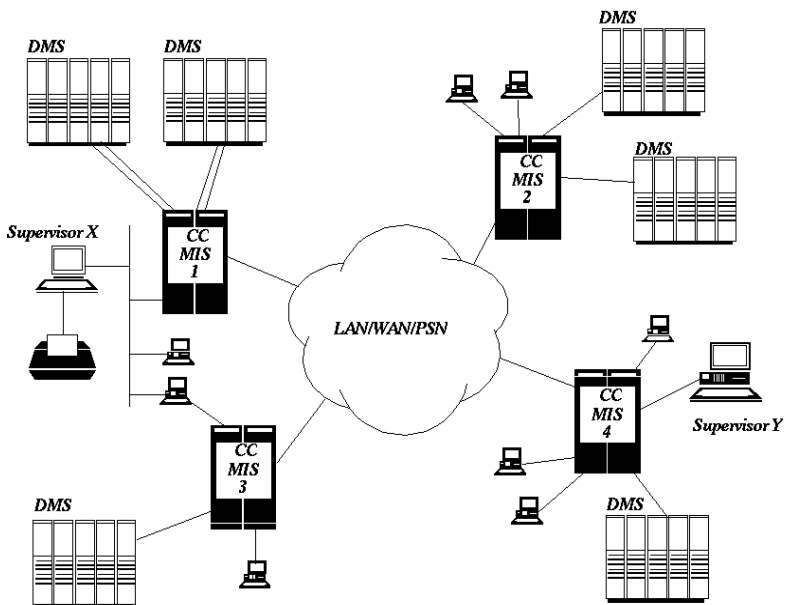

**Key Terms**

*Network Access Partition (NAP)*

-  
A partition that provides access to other partitions in the network. **Note:** NAPs can only exist on a Network Node.

*Local Partition*

-  
A partition that provides access to local data only.

*Network*

-  
A collection of nodes. The nodes may be the actual VMEs or partitions depending on the type of network (physical or virtual).

*Virtual Network*

-  
A network comprised of local partitions that can be accessed by the NAP (defined in the Virtual Network screen).

*Physical Network*

-  
A network of CC MIS systems. The IP addresses of the host systems are specified in the Physical Network screen.

*Network Node*

-  
A physical node that has Networked CC MIS capabilities.

*Physical Node*

-  
A physical CC MIS system.

*Virtual Node*

-  
A partition in a CC MIS Virtual Network. This is a local partition.

*System (Node)*

-  
The CC MIS host platform (computer).

**Overview of a Network**

The illustration below depicts an application of the Networked CC MIS feature. There are four nodes each running separate CC MIS systems with one or more partitions defined. There are four supervisors, three of which (A, B, and D) have a direct connection (bold lines indicate direct connection) to a Network Access Partition (NAP) and one (C) that connects only to a local partition.

Figure 8.1 Network Overview

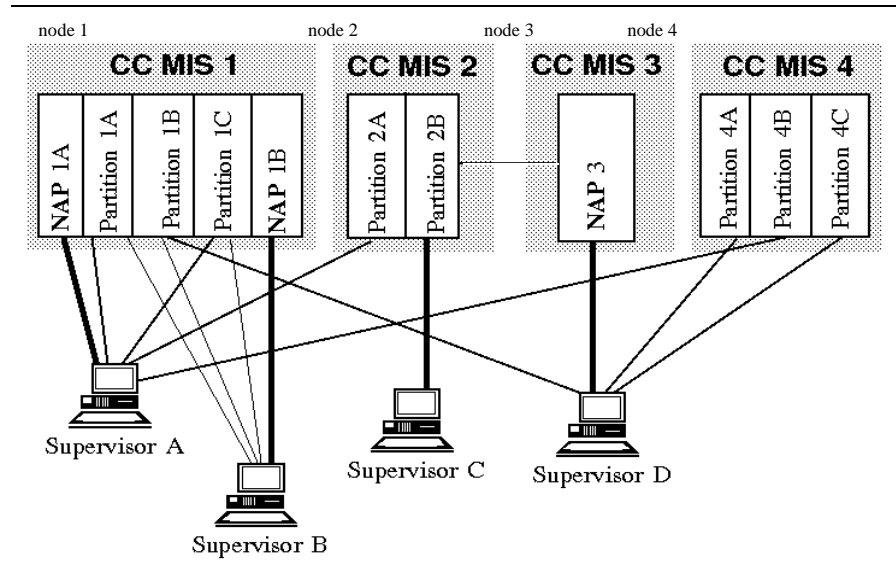

**Note:** Bold lines indicate direct connections. Other lines indicate NAP's ability to view partitions defined in the Virtual Network for the NAP.

**Views in the Network**

Based on the configuration above, each supervisor would have access to view the following partitions:

*Supervisor A* - Through NAP 1A can view Partition 1A, Partition 1C, Partition 2A, and Partition 4B.

*Supervisor B* - Through NAP 1B can view Partition 1A, Partition 1B, and Partition 1C.

*Supervisor C* - Is a local supervisor and can only view Partition 2B.



To access network MIS data, a supervisor must establish a session with a NAP.

*Supervisor D* - Through NAP 3 can view Partition 1B, Partition 4A, and Partition 4C.



### Maximums for Networks

Each NAP added to the system reduces the number of local partitions allowed by four.

Maximum number of NAPs allowed on your system is set in the installation tape by the Maximum NAPs field (values: 0 - 4)

## Steps for Establishing a Network

The following are the basic steps used to establish a network:

1. The Network feature for the CC MIS system must be enabled. (This feature is enabled in the software installation tape. The two customer options that enable this feature are Networking and Maximum NAPs.)
2. Setup the network configuration using the System Configuration command from the Configuration menu. (Specify a CC MIS network name.)
3. Define the physical network using the Physical Network Configuration command. (Identify all of the CC MIS systems to be included the network.)
4. Define local partitions (refer to Chapter 7).
5. Define the NAP (using Partition Configuration), then specify all of the virtual nodes (local partitions) that the NAP will access in the network using the Virtual Network Configuration option from the Configuration Options menu.
6. Define the intervals for the NAP by accessing the Interval Configuration screen (if enabled) from the Configuration Options menu (refer to Chapter 7).

The Configuration menu contains the commands needed to establish a network. The Configuration menu is shown in the figure below.

Figure 8.2 Configuration menu

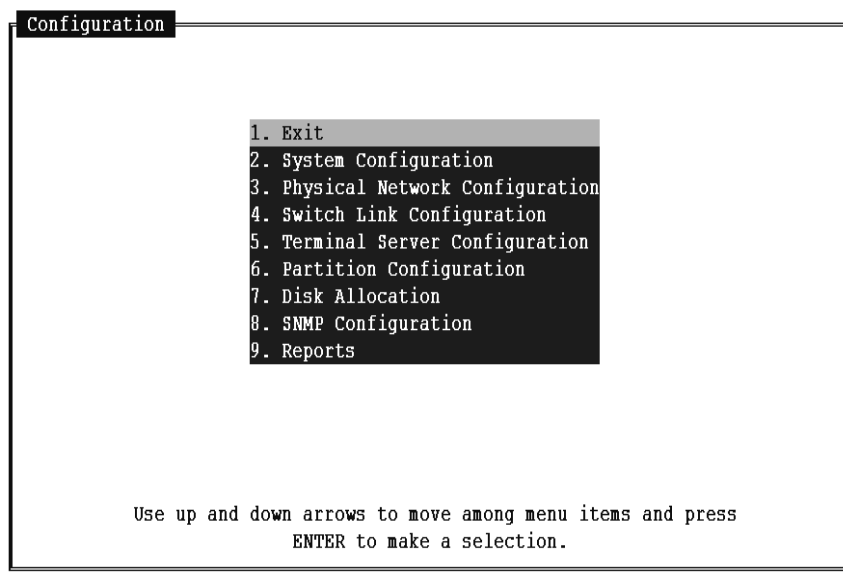

F12=Help

Refer to Chapter 2 in the *System Description* (NTP 297-2671-150) for additional information on CC MIS system capacities.

## System Configuration

The system configuration screen contains system-wide data. This is the first screen accessed when setting up a new system. Information contained in this screen includes the system name, network parameters, and the maintenance printer setup.

Security for a networked CC MIS is accomplished using a network name. The Network Name field was added to System Configuration to support the definition and security of the network. All nodes belonging to a particular network must have the same Network Name.

The Network Name received in a message is examined in order to determine if a message should be processed. Messages that are received that do not have the correct Network Name are discarded.



The Network Name field appears when the Networking option is enabled. The system must be down to edit this field.

Figure 8.3 System Configuration screens

### PowerPC Platform

```

System Configuration
-----
System Name:          Power200
** CC MIS Network Name:

LAN Parameters:
  Network Hostname:   carpyc08
  Network Address:    47.81.160.177
  Network Mask:       0xfffff000
  Default Gateway:    47.81.160.1

Maintenance Printer Definition:
  Unix Printer:
  Printer Model:
  Printer Name:

** NOTE: The

F12=Help  F1=
    
```

```

System Configuration
-----
Node Name:           San Angelo
CCMIS Network Name:  Southwest

LAN Parameters:

  Network Hostname:   concho
  Network Address:    123.71.160.105
  Network Mask:       0xfffff000
  Default Gateway:    123.71.160.1

Maintenance Printer Definition:

  Port:               lp187_c0d0
  Modem:
  Baud Rate:
  Printer Model:      HP LaserJet
  Printer Name:       LaserJet1

F9=Help  F1=Commands  F4=Port Allocation
    
```

187 & 197  
Platforms

## Guidelines

Perform the steps below to access the System Configuration screen.

### Step 8-1: Accessing the System Configuration screen

1. Access the Maintenance and Administration menu.
2. Select Configuration to access the Configuration main menu.  
  
The system displays the Configuration main menu.
3. Select System Configuration to access the System Configuration screen.

## Field descriptions

The system configuration screen fields are described in the table below.

**Table 8-1: System configuration field descriptions**

Field	Description
Node Name	The system name appears on configuration reports. This name can be up to 16 characters in length.
CC MIS Network Name	This name can be up to 16 characters in length and will identify the CC MIS network with which this node is associated. This field provides network access and security.
Network Hostname	This name can be up to 15 characters in length. This is the name that appears when the "uname -n" command is executed on the system at the UNIX prompt.
Network Address	This is the network IP address that uniquely identifies the system on the LAN.
Netmask	Used by routers to determine which bits of an IP address is the network address.
Default Gateway	Address of the gateway to the network on which CC MIS is located.

Table 8-1: System configuration field descriptions

Field	Description
Maintenance Printer (187 & 197 platforms)	<p>Printer where the maintenance reports and logs are spooled. This is a direct-connect, hard-wired printer. The maintenance printer can be added to any port which is not currently in use by a partition.</p> <p>Press the Options menu to select ports, modem, baud rate, and printer models. (Up to 25 characters can be entered for the printer name.) Use the port allocation key to view port allocations.</p> <p><i>Note:</i> The maintenance (system) printer can be connected to the VME using the parallel port.</p>
Unix Printer (PowerPC platform)	<p>Printer where the maintenance reports and logs are spooled. This is a direct-connect, hard-wired printer. The unix printer can be added to any port which is not currently in use by a partition.</p>

## Physical Network Configuration

Various components of the CC MIS need to know the node ID and address (IP address or host name) of CC MIS systems within its physical network. Nodes that have NAP Partitions which gather information from other nodes must use this screen to specify the addresses of those nodes in the Physical Network Configuration.

The views of the physical network may vary from node to node depending upon whether NAP partitions are used, and to which remote nodes the local node has access.

Selecting Physical Network Configuration from the Configuration main menu displays the Physical Network Configuration screen.

**Note:** System configuration must be completed before accessing the physical network configuration screen.

Figure 8.4 Physical Network Configuration screen

Physical Network Configuration		
PHYSICAL	NODE	
NODE NAME	ID	ADDRESS
Snoopy	0	47.81.160.102
Spin	1	47.81.160.105
S900	2	47.81.160.138

F12=Help F1=Exit

The local node (Node ID 0) is listed as part of the physical network configuration. Initially the Node Name and Address are collected by the system configuration. (The address field cannot be changed.)

**Note:** When the system is down, the System Down text string is displayed in the upper left hand corner of the screen. The string appears in all configuration screens until the system is started.

The fields in this screen are described in the table below.

**Table 8-2: Physical Network screen definitions**

Field	Description
Physical Node Name	A descriptive name for the node. This name is not associated with the System Name in the System Configuration screen.
Node ID	A 1 to 2 digit ID used by CC MIS to identify a physical node on the network. This ID is assigned by the system and cannot be modified.
Address	The IP address of the node.

The function keys associated with this screen are listed in the table below.

**Table 8-3: Physical Network Function keys**

Key	Description
Exit	Exits the current screen.
Edit Field	Allows you to edit or modify information in the selected field.
Add Node	Adds a node to the Physical Network. Displays a window prompting for the information for the new node.  <i>Note:</i> If the maximum number of nodes has been reached, the Add Node key is not displayed.
Delete Node	Deletes a node from the Physical Network. Displays a list of Physical Nodes from which to select a node to be deleted.  A confirmation screen is displayed before the selected node is deleted.  <i>Note:</i> The Delete Node key is available only when nodes have been defined.

### Adding a node to the physical network

A node can be added to the physical network by selecting the Add Node command (function key) and entering the Node Name and Address. The following screen shows the Add Node window.

Figure 8.5 Add Node menu

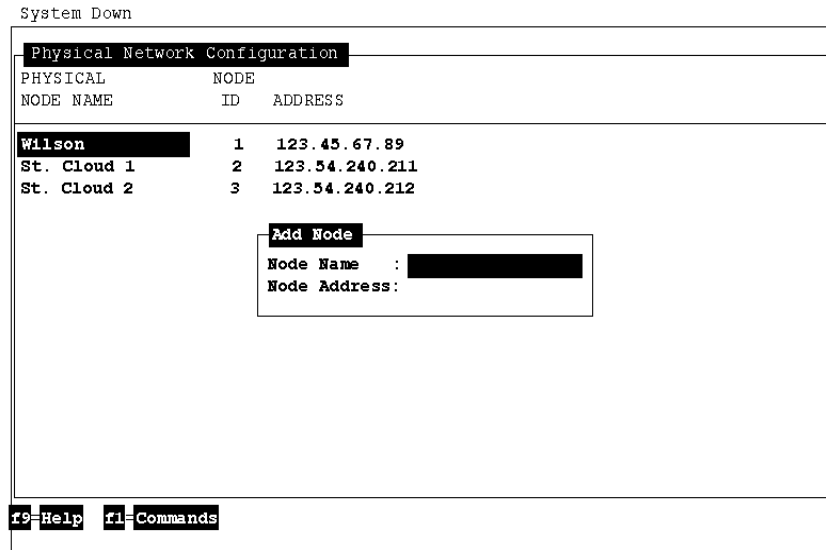

After the node name and address are specified, select the Commands menu, then select the Submit option to add the node or Cancel to cancel the add action. The following screen shows the Add Node window with its commands menu.

Figure 8.6 Add Node Commands menu

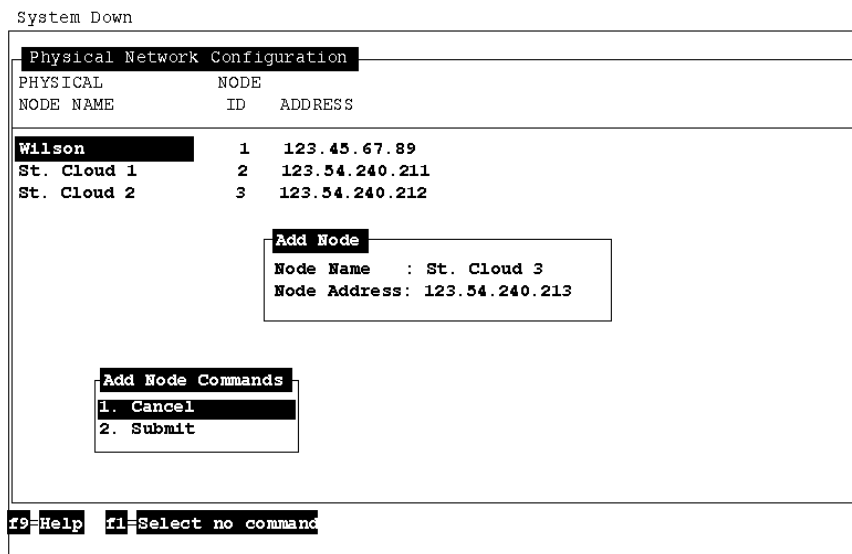

The commands in the Add Node Commands menu are listed in the table below.

**Table 8-4: Add Node commands**

Command	Description
Cancel	Aborts the Add Node procedure.
Submit	Submits and adds the node to the Physical Network Configuration with the entered name and address, then exits the Add Node Procedure.

### Deleting a node from the physical network

A node can be deleted to the physical network by selecting the Delete Node command (function key) and selecting the node to be deleted from the list of nodes appearing in the popup window. The Delete Node window is shown in the figure below.

**Figure 8.7 Delete Node menu**

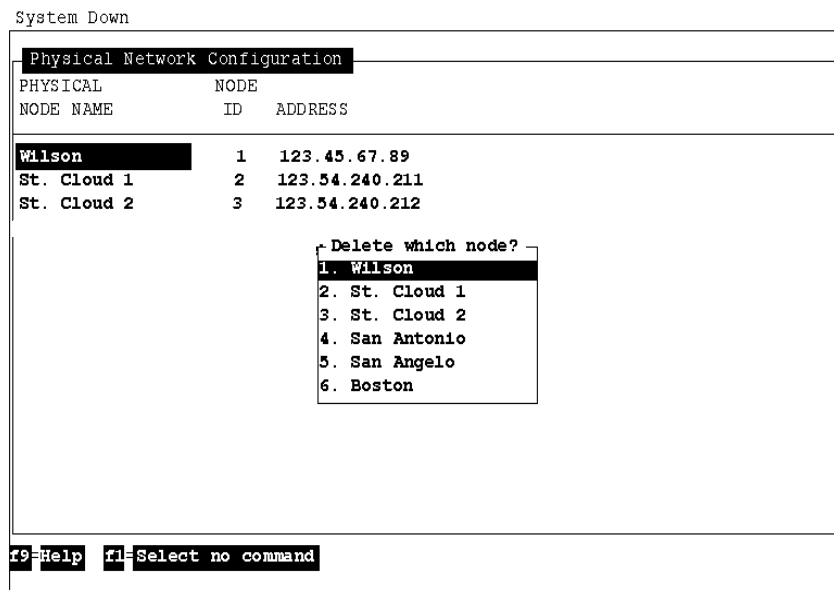

Issues concerning the deletion of a physical node:

- A physical node cannot be deleted if it is still referenced in a virtual network configuration (on this system).
- Deleting a physical node will not affect Physical Network or Virtual Network configurations on other CC MIS systems.



## Switch Link Configuration

The switch link configuration screen is used to create multiple link definitions. Links can be live or simulated. (See Section 6 for information on defining switch links.)

## Partition Configuration

When the network feature is enabled, you can define two types of partitions: local and NAP.

*Local partitions* are partitions located on the physical node that store MIS data (same as the partitions defined in Release 3.x). These partitions can operate in one of four modes: Startup, Training, Precut, and Product. A node can have up to multiple partitions, each partition operating in a different node. Local partitions have access to local data only. Use the procedures in Sections 6 and 7 to define local partitions.

*NAPs* are partitions that are used to access other partitions in the network. NAPs can only be added if the Networking feature is enabled and the maximum number of NAPs is set greater than zero. Unlike local partitions, NAPs do not receive data from switch, do not store data, and therefore do not require any data storage parameters. A NAP must be defined to access network MIS data. NAPs can only be added to a Network Node. The process for defining NAPs and establishing networks is described in this section.

The maximum number of partitions is set at the time of purchase and the installation of the customer options tape.

Figure 8.8 Partition Configuration screen

Partition Configuration					
PARTITION NAME	MODE	STATE	PTN		SWITCH LINK
			ID	DISK	
West	Product	Running	1	1	(NAP)
A-1 Airlines	Product	Running	2	1	1 - Live - ACDPOOL3
Acme Mortgage	Product	Running	3	2	1 - Live - ACDPOOL3
East	Setup	Stopped	4		(NAP)
B & O RR	Precut	Stopped	5	2	2 - Live - ACDPOOL4
BankUSA	Product	Running	7	3	1 - Live - ACDPOOL3
World Travel	Setup	Stopped	8		(Not Defined)
Mail Orders R Us	Product	Running	9	2	2 - Live - ACDPOOL4
First National	Training	Stopped	10	3	3 - Simulator - ACDPOOL0

f9=Help f1=Exit f3=Edit field f4=Configuration Options f12=>>



The Add Partition, Delete Partition, and Validate Partition function keys are displayed by pressing the F12 function key. The Validate Partition option is available for both local and NAP partitions.

The function keys in this screen are listed below:

**Table 8-5: Function key commands**

Key	Description
Exit	Exits the current screen.
Add Partition	<p>Adds a partition. A window is displayed to select the partition type (Local or NAP) and to enter the partition name.</p> <p><i>Note:</i> If NAPs are not allowed on the system (Maximum NAPs = 0), then the partition type field will not appear in the pop-up window, and the partition name is input as described in Chapter 7.</p>
Delete Partition	<p>Deletes a partition. A window containing a list of partitions is displayed from which the partition to be deleted is selected. A confirmation window is displayed before the partition is deleted.</p> <p><i>Note:</i> The Delete Partition key is available only if a partition has been configured.</p>

The Partition Configuration screen showing the Add Partition window is shown in the figure below.

Figure 8.9 Add Partition options menu

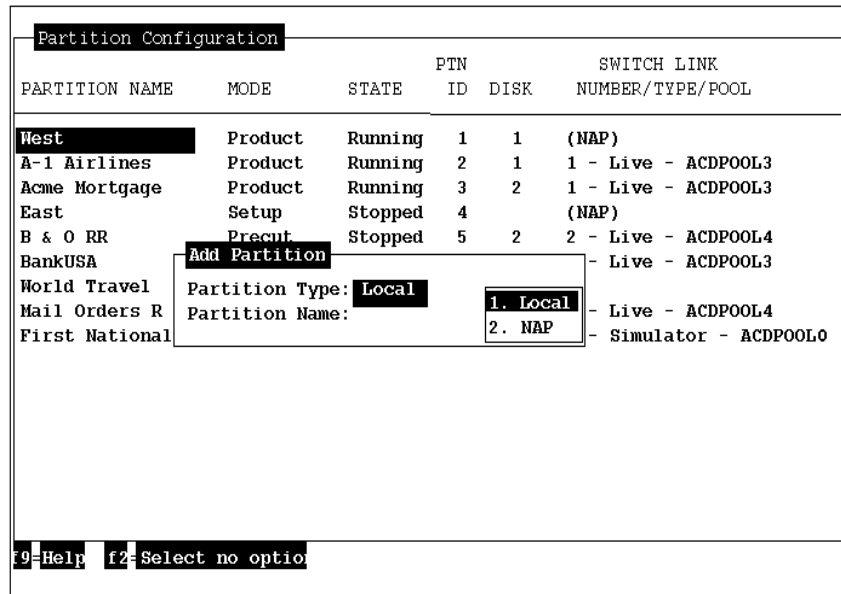

**Note:** The Local or NAP type is selected from the popup menu. The Add Partition function key is not displayed on the screen if the limits for both partition types have been reached. If the limit for one partition type (for example, NAP) has been reached and the other (Local) has not, then the function key is displayed.



The Partition Type in the Add Partition window is set to display as the default the partition type that has not reached its limit. (The other type is grayed in the Partition Type options list.) If neither partition limit has been reached, the default type is set to Local.

The Partition Configuration with the Add Partition window and the commands menu displayed is shown below.

Figure 8.10 Add Partition and Commands menus

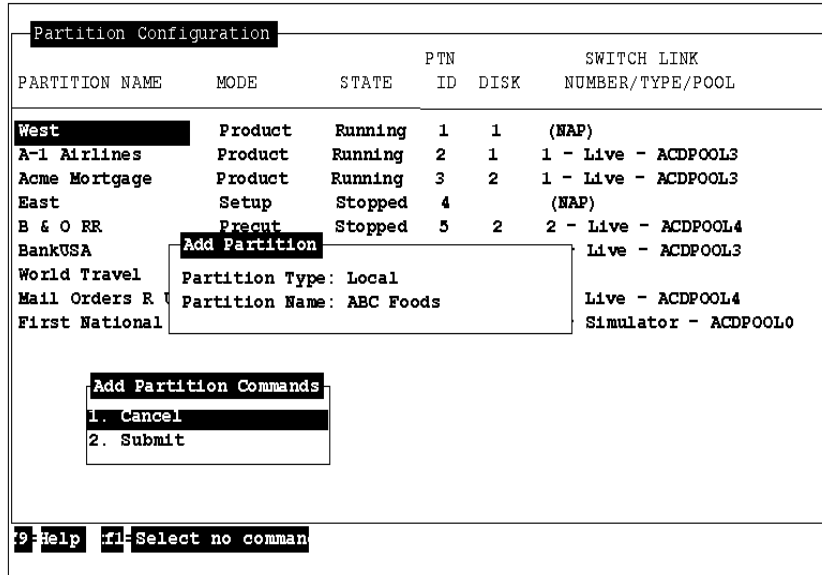

The commands in the Add Partition Commands menu are listed below.

Table 8-6: Add Partition commands menu

Command	Description
Cancel	Aborts the Add Partition procedure.
Submit	Adds the partition to the Partition Configuration with and exits the Add Partition procedure.

Partitions must be defined using the Partition Configuration screen. Partition names can be up to 16 characters in length. The initial settings for a new partition are Mode=Setup and State=Stopped. The partition type (local or NAP) is specified when adding a partition. The NAP option will not be available to nodes that are not allowed to have NAPs or if the Maximum limit of NAPs has been reached.



NAPs are used to access local partitions within the network. After the NAP is added, select the Virtual Network Configuration option from the Configuration Options menu on the Partition Configuration screen to specify which local partitions can be accessed by the NAP. (The Virtual Network Definition screen is described later in this chapter.)

### Guidelines

Perform the steps below to access the Partition Configuration menu and add a NAP.



Refer to Chapter 7 for information on adding Local partitions.

## Step 8-2: Adding a NAP

1. Access the Maintenance and Administration menu.
2. Enter Configuration to access the Configuration main menu.  
The system displays the Configuration main menu.
3. Select Partition Configuration to access the Partition Configuration screen.
4. Press the Add Partition key and specify NAP as type.
5. Enter name for partition to be added (up to 16 characters).
6. Select Submit.



A NAP can only be set to Setup or Product mode.

## Deleting a Partition

Deleting a partition in a network does not delete occurrences of that partition in Virtual Network Configuration on other nodes in the network or on the NAPs on local node.



This configuration information is not automatically deleted because it is possible that nodes may be disconnected or down during configuration changes.

The following conventions are used when the partition name for a partition on a remote node cannot be determined:

- If the partition has been deleted, the partition name is displayed as (DELETED).
- If the physical node is down, any partition names associated with it is displayed as (UNAVAILABLE).

Perform the steps below to access the Partition Configuration menu and delete a partition.

### Step 8-3: Deleting a partition

1. Access the Maintenance and Administration menu.
2. Enter c to access the Configuration main menu.  
  
The system displays the Configuration main menu.
3. Select Partition Configuration to access the Partition Configuration screen.
4. Press the Delete Partition key.
5. Menu appears with a list of partitions.
6. Select the partition to delete.
7. Confirm the deletion in the dialog box that appears.
8. The partition is deleted and the system resources used by that partition are freed.

### Partition configuration options

The Configuration menu is displayed by selecting the Configuration Options command (function key) from the Partition Configuration screen. The Configuration Options menu is shown in the figure below.

Figure 8.11 Configuration Options menu

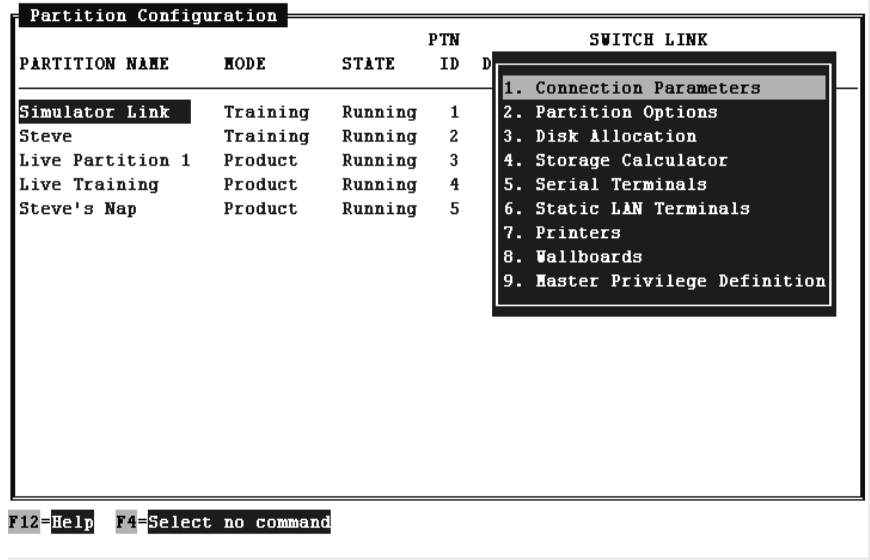

The following options are available using the Configuration Options function key. Highlight a partition and from the Options menu select the options as listed below

**Table 8-7: Partition configuration options**

Option	Function
Connection Parameters	Displays the Connection Parameters screen.
Partition Options	Displays the Partition Options screen. Partition options include: <ul style="list-style-type: none"> <li>• Data export</li> <li>• Language Support</li> <li>• Use of Maintenance Printer</li> <li>• Nightly Backups</li> <li>• APR (Local partitions only)</li> <li>• SNMP Support</li> <li>• Flexible Intervals</li> <li>• Maximum ACD Groups</li> <li>• Maximum Positions</li> <li>• Maximum Wallboard Ports</li> <li>• Maximum Supervisor Connections</li> <li>• Maximum Logins</li> </ul>
Disk Allocation	Displays the Disk Allocation screen.
Flexible intervals	Displays the Interval Configuration screen. <i>Note:</i> Displayed only if purchased.
Serial Terminals	Displays the Serial Terminals screen.
Static LAN Terminals	Displays the Static LAN Terminals screen.
Printers	Displays the Printers screen.
Wallboards	Displays the Wallboards screen.
Master Privilege Definition	Displays the Master Privilege Definition screen.
Virtual Network Definition	Displays the Virtual Network Definition screen. <i>Note:</i> This option is not listed if the partition is not a NAP.

**Disk Allocation**

Partition data must reside on one disk. However, a disk may contain several partitions. Therefore, resource limits must be set for each partition. The Disk Allocation screen allows you to assign a disk to a partition. (See Section 7 for additional information and procedures for assigning disks in CC MIS.)



## Virtual Network Configuration

The Virtual Network Configuration screen is used to define which Local Partitions can be accessed from a NAP partition. These partitions comprise the virtual network with which the NAP is associated.

The Virtual Network Configuration screen is shown in the figure below.

Figure 8.12 Virtual Network Configuration screen

PHYSICAL NODE NAME	NODE ID	LOCAL PARTITION NAME	PTN ID	PTN CODE
San Antonio	5	Pancoast B&B	4	SANT
San Angelo	6	Levis	3	SNG1
San Angelo	6	Jalapeno's	4	SNG2

F9=Help F1=Exit F3=Add Partition F6=Delete Partitio

The Virtual Network Configuration screen fields are described in the table below.

Table 8-8: Virtual Network Configuration field descriptions

Field	Description
Physical Node Name	The name of a Physical Node.
Physical Node ID	The ID of a Physical Node.
Local Partition Name	The name of the Local Partition on the Physical Node that may be accessed via the NAP.
Local Partition ID	The ID of the Local Partition.
Partition Code	This is an editable field used to enter a four character alpha-numeric partition identifier.  <i>Note:</i> This identifier is used in a network to create unique agent IDs subgroups, and position IDs.

The Virtual Network Configuration screen function keys are described in the table below.

**Table 8-9: Virtual Network Configuration function keys**

Key	Description
Exit	Exits the current screen.
Add Partition	Adds a partition to the virtual network. This command displays a list of Physical Node / Local Partition pairs from which a partition to add can be selected. Partitions that have already been selected are grayed.
Delete Partition	Deletes a partition from the virtual network. This command displays a list of Physical Node / Local Partition pairs from which to select a partition to delete. A prompt is displayed before the partition is deleted. This key does not appear if no partitions currently exist in the virtual network.

The Add Partition to Network window is shown in the figure below.

**Figure 8.13 Add Partition to Network screen**

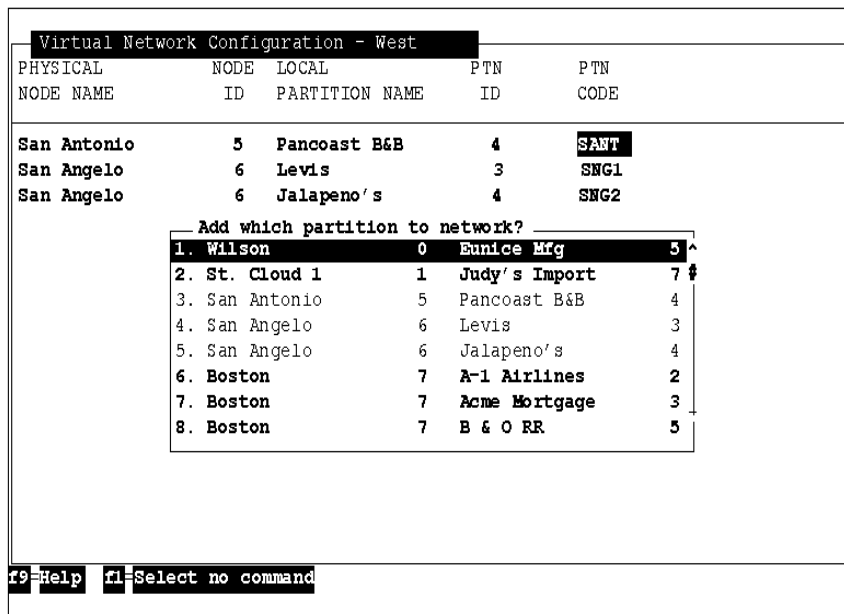

The Delete Partition from Network window is shown in the figure below.

Figure 8.14 Delete Partition from Network screen

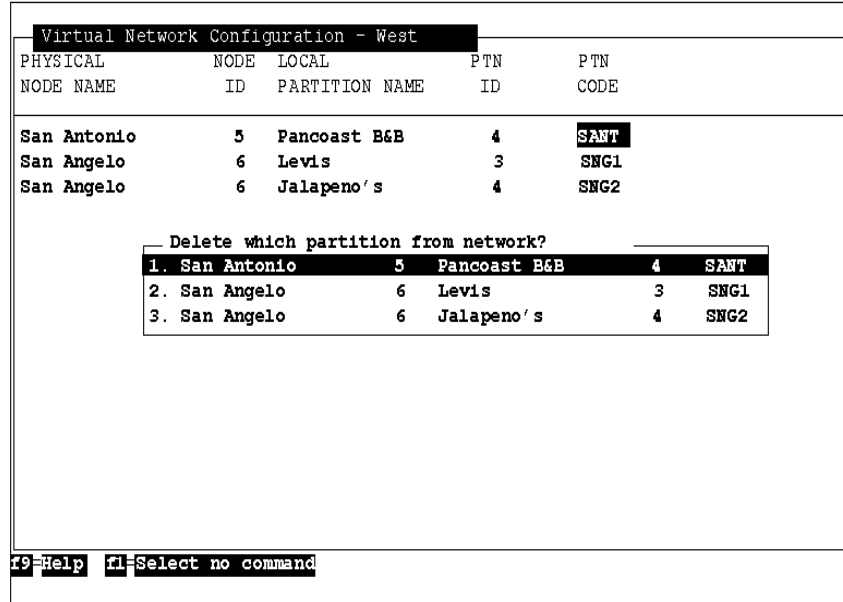

The Delete Partition from Network confirmation window is shown in the figure below.

Figure 8.15 Delete Partition from Network confirmation screen

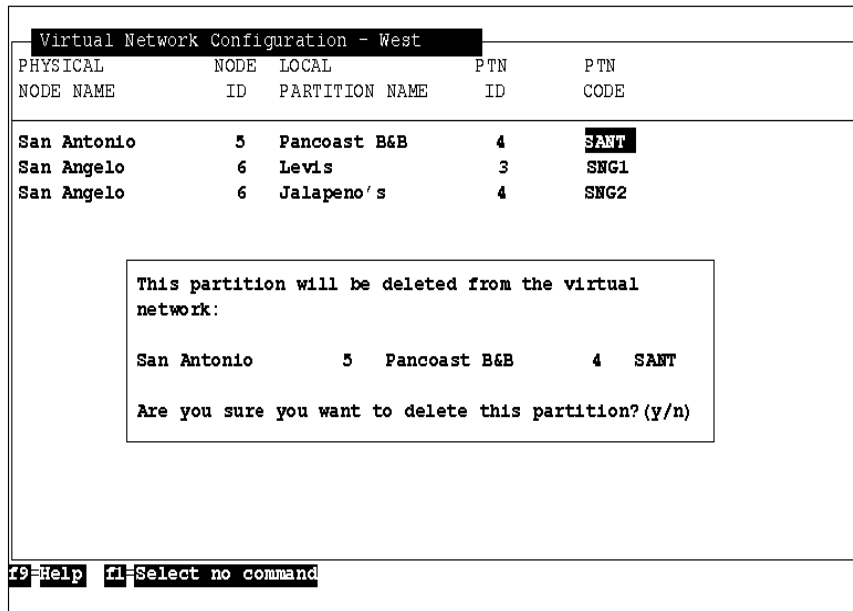

## Partition options

The Partition Options screen is used to specify a subset of capabilities for use by a single partition. For changes to take effective immediately, the partition must be shutdown and restarted.



The values in the brackets [ ] next to maximum fields indicates the range of available resources, which is calculated by system wide limits minus the resources already in use by other partitions.

Therefore, the valid range for any field with numerical value is the system limits defined in the option of the distribution tape minus the sum of all the other partitions' values. The values of each field for all partitions are added together and compared to the system limit.

The Partition Options screen is shown in the figure below.

Figure 8.16 Partition options screen

```

Partition Options - First
|
| Data Export : Enabled
| Language Support : Enabled
| Use of Maintenance Printer : Enabled
| Nightly Backups : Definitions Only
| Automatic Position Reassignment : Enabled
| SNMP Support : Disabled
| Flexible Intervals : Enabled
| Maximum ACD Groups [1-663] : 40
| Maximum Positions [1-2732] : 200
| Maximum Wallboard Chains [0-47] : 4
| Maximum Supervisor Connections [0-487]: 4
| Maximum Logins [0-39] : 4
|
| Custom Time Zone Specification : EST5EDT
|
| Dynamic LAN Terminal Access : Enabled
| Access Password : misrus
|
F12=Help F1=Commands F2=Options

```

The table below describes the fields of the Partition Options screen.

**Table 8-10: Partition options screen fields**

Parameter	Description
Data Export	Enables or disables the ability for the partition to use the CC MIS Data Export feature.
Language Support	Enables or disables the ability for the partition to make use of multiple languages.
Use of Maintenance Printer	Enables or disables the ability for the partition to use the system maintenance printer for printing the partition's reports.
Nightly Backups	<p>Configures automated nightly backups for this partition.</p> <p><i>Disabled</i> - No nightly backups performed for this partition.</p> <p><i>Enabled</i> - All partition data is backed up.</p> <p><i>Definitions Only</i> - Only the partition's definitions database is backed up. This is useful when data database is very large and is already protected by a RAID device. Backing up definitions allows for recovery from accidental deletion of definitions.</p> <p><i>Data Only</i> - Only the partition's historical data database is backed up.</p>
Automatic Position Reassignment	<p>Enables or disables the ability for the agents associated with this partition to be automatically reassigned to specified groups based upon their login ids.</p> <p><b>Note:</b> Only available for Local partitions.</p>
SNMP Support	<p>Enables or disables the SNMP feature for the selected partition.</p> <p><b>Note:</b> Optional feature.</p>
Flexible Intervals	<p>Enables or disables flexible interval configuration for this partition.</p> <p><b>Note:</b> Optional feature. Available only if enabled on the system.</p>

**Table 8-10: Partition options screen fields**

Parameter	Description
Maximum ACD Groups	<p>Maximum number of ACD groups the partition may datafill in the Storage Calculator.</p> <p><i>Note:</i> Acceptable ranges for this field differ depending on the type of partition: Local or NAP.</p>
Maximum Positions	<p>Maximum number of agent positions the partition may datafill in the Storage Calculator.</p> <p><i>Note:</i> Acceptable ranges for this field differ depending on the type of partition: Local or NAP.</p>
Maximum Wallboard Ports	<p>Maximum number of wallboard ports the partition may use. A zero value indicates that the Wallboard option is not enabled.</p>
Maximum Supervisor Connections	<p>Maximum number of connections, including hard-wired, LAN, and pass-through that this partition can have at one time. This information is used to limit the number of running processes on the system. This field must be greater than or equal to the Maximum Logins field.</p>
Maximum Logins	<p>Maximum number of supervisors that can be logged in to the system for the partition at a given time. This field must be less than or equal to the Maximum Supervisor Connections field.</p>
Dynamic LAN Terminal Access	<p>Allows the Supervisor Terminal in the Windows interface to connect to the partition without the terminal's address being defined in the Static LAN Terminal screen. (This field enables the DHCP feature that was added in Release 5.0).</p>
Partition Password	<p>When Enabled, enter a password for the partition.</p>
Confirm Password	<p>Confirm the password by re-entering it on this field</p>

## Guidelines

Perform the steps below to access the Partition Options screen.

### Step 8-4: Accessing the Partition Options screen

1. Access the Maintenance and Administration menu.
2. Enter c to access the Configuration main menu.  
  
The system displays the Configuration main menu.
3. Select Partition Configuration to access the Partition Configuration screen.
4. Press the Configuration Options function key to display Configuration Options menu.
5. Select Partition Options from the Configuration Options menu.

The system displays the Partition Options screen.

**Note:** Supervisor Privileges and Port configuration is described in Section 7 of this guide.







## Section 9: Monitoring system functions



 *Diagnostics main menu*

 *Test I/O ports*

 *TCP / IP switch link diagnostics*

 *Free disk space*

 *View, monitor, and print logs*

 *X.25 diagnostics*

 *File transfer function*

 *System monitor status*

### Introduction

The CC MIS system has a number of diagnostic tools available through the maintenance interface. This chapter provides procedures for all of the utilities available to the user through the CC MIS Diagnostics menu.

You access the diagnostic utilities listed below through the Diagnostics menu. The menu shown in the figure below is displayed when CC MIS is running and when not dialed in remotely.

Figure 9.1 Diagnostics menu (when software is running)

```

Call Center MIS Diagnostics [MISVME5]
Release 5.1.0.BNR.40

Display Free Disk Space      Test Individual I/O Ports
Logs                         View System Monitor
Reset Modem Port
Link Trace
X.25 Diagnostics
TCP/IP Switch Link Diagnostics
Help                          Quit

Press d,i,l,v,r,t,x,s,h or q and RETURN: █

```

When CC MIS is not running, the Test All I/O Ports command replaces the Test Individual I/O Ports command.

### Accessing the diagnostics menu

Perform the steps below to access the Diagnostics menu.

## Step 9-1: Accessing the Diagnostic menu

1. Access the Maintenance and Administration menu.
2. Enter *d* to access the Diagnostics menu.

The system displays the Diagnostics menu.

## Displaying free disk space

The Display Free Disk Space command determines the amount of disk space remaining on all attached disks. The screen displays each partition's disk usage information for each disk.

The CC MIS software automatically purges data from the database based on the storage duration specified. Therefore, if more space is required for your database, the historical database parameters may need to be changed.

Figure 9.2 Display Free Disk Space screen

Display Free Disk Space					
Partition Name	Size Limit	Space In Use	% In Use	Disk No.	% Disk Alloc
Abbey	75M	55M	73	1	6
Bryan	100M	53M	53	2	10
Dave	70M	63M	90	2	7
Feng	90M	59M	65	2	9
John 2	60M	50M	83	2	6
John 1	60M	57M	95	2	6
Mickey	75M	56M	74	2	8
New	100M	50M	50	2	10

DISK USAGE STATISTICS					
Disk No.	Mount Directory	Disk Size	Avail Space	%Full	Num Ptns
-	/	27M	5M	80	-
-	/bnr/disk1	1247M	810M	35	-
-	/bnr/disk2	1247M	178M	85	-
-	/bnr/fm	1868M	281M	84	-

F12=Help F1=Exit F4=Switch to disk section

Perform the steps below to display the amount of free disk space.

### Step 9-2: Displaying free disk space

1. Access the Diagnostics menu.
2. Enter *d* to display disk space.

The system displays the Display Free Disk Space screen.

3. Press Exit to exit and return to the Diagnostics menu.

## File transfer

### PowerPC Platform

The File Transfer command is not used on the PowerPC platform.



This section is only for users logged in through the maintenance modem. This option is not available during normal operation.

The File Transfer command displays a File Transfer screen. This screen allows the user to select the file to be transferred. There are several types of files kept by the system that can be transferred. They are: System log, Maintenance log, Install log, Backup log, Restore log, Link Trace file and Initialization data file. If the date and time filtering has been selected on the system log, then only those messages within the specified date and time range will be transferred. The system log includes filtering by partitions.



The File Transfer command is available only when the Motorola VME is accessed as a remote maintenance console. Transfer software on the PC used to dial into the VME is not provided with the CC MIS software.

Figure 9.3 File Transfer screen

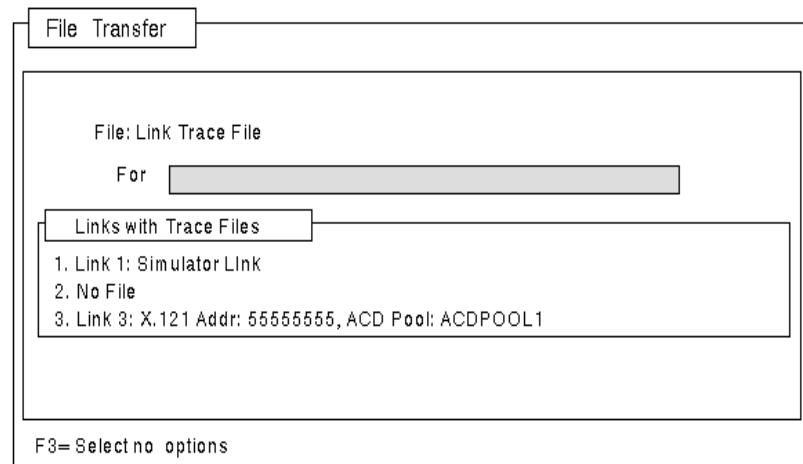

Perform the steps below to perform a file transfer.

### Step 9-3: Performing a file transfer

1. Access the Diagnostics menu.
2. Enter *f* to display the File Transfer screen.  

The system displays the File Transfer screen.
3. Press the Options function key.  

The system displays the files available for transfer.
4. Select a file and press <Return>.
5. If the file selected is not a Link Trace file or Init Data, then skip to step 8.
6. Press the Options function key.  

The system displays the files available for transfer.
7. Select a Link Trace file and press <Return>.
8. Press the Commands function key.  

The system displays the Commands popup menu, which includes the Exit and Transfer commands.
9. Select Transfer and press <Return>.  

The system displays a list of supported protocols (currently Kermit and Zmodem).
10. Select the appropriate protocol and press <Return>.
11. The system displays further instructions depending on the protocol selected in step 10.

---

The Test All I/O Ports command is not available on PowerPC platforms.

---

## Testing the input/output ports

The Test All I/O Ports command determines the system's ability to communicate with all configured terminals and printers attached to the system. The system tests all the configured asynchronous ports at once by sending a message to each device connected to the I/O ports. If the device is connected properly, a message is displayed on the screen, or on paper (printers).



This command will not test Supervisor terminal ports.

In order to automatically test all input/output ports, you must manually shut down CC MIS. (Command is only available when CC MIS is not running.)

Perform the steps below to test all ports.

### Step 9-4: Testing all ports

1. Manually shut down software using the Shutdown the CC MIS System option on the Run State Utilities menu.
2. Access the Diagnostics menu.
3. Enter *i* to test the ports. (Note: Does not test Windows ports.)

The maintenance console displays the following message:

**Testing all ports. . . .**

Note: Additional messages may be displayed concerning the test and possible problems with a port. For example:

**Testing 1 modem-connected display port ...  
m337\_c0d5 ... may have a problem.**

4. Check the printer or the screen of the terminal in question for the following message:

**This is a test of port /dev/port/m337\_c0d3.**

The system identifies the port number in the message above.

5. Press <Return> to access the Diagnostics menu.

---

The Test Individual I/O Ports command is not available on PowerPC platforms.

---

## Test individual I/O ports

The Test Individual I/O Ports command determines the system's ability to communicate with an individual port. The Test Individual I/O Ports command is available only when CC MIS is running.



Testing a port that is in use may have undesirable results and is not recommended.

Figure 9.4 Test individual I/O screen

---

```
Test Individual I/O Ports ...
```

```
The following ports may be tested:
```

```
lp0          m337_c0d7          m337_c0d8
```

```
WARNING: Undesirable results may occur if a port that is in use is tested.
```

```
Enter the name of the port to test or q to quit:
```

---

Perform the steps below to test an individual port.

### Step 9-5: Testing an individual port

1. Access the Test Individual I/O screen from the Diagnostics menu.
  2. At the prompt, type the name of the port to be tested.
  3. To exit, type *q* at the prompt.
-

## Logs

The Logs screen allows access to several logs kept by the system. The user can select which log he wishes to view by using the Options key to bring up the list of logs. The default selection is the System log.

The user has access to all of the following types of logs:

- System log - This log contains log messages that are generated by the CC MIS system.
- Maintenance log - This log contains log messages that are generated by the maintenance interface.
- Install log - This log contains information and errors pertaining to the installation process.
- Backup log - This log contains errors and information that are generated during the backup process.
- Restore log - This log contains information and errors generated during the restore process.

The figure below shows the System Logs screen, with the Option menu displaying the available log files.

Figure 9.5 CC MIS system logs screen

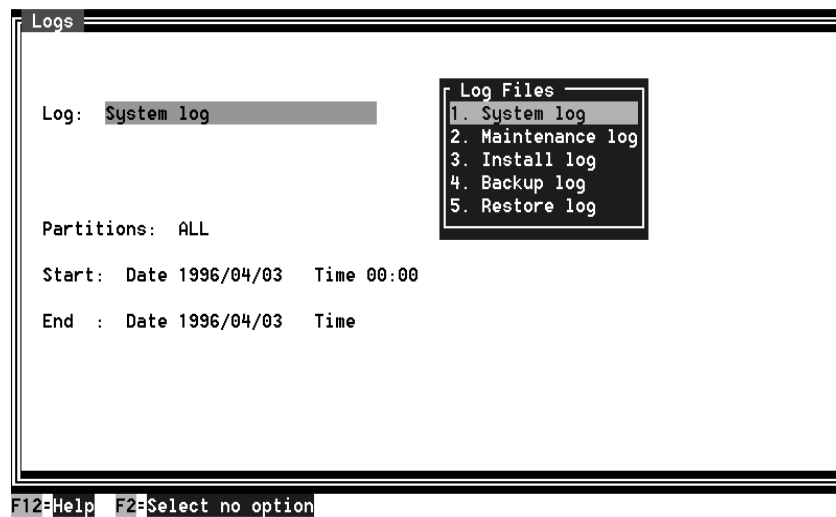



The table below defines the logs screen fields.

**Table 9-1: Logs screen fields**

Parameter	Description
Partitions	This field is used to select log messages for viewing or printing based upon the partition with which the message is associated. The list of partitions can include one or more partition numbers or ranges separated by spaces. (For example, 0 2-5 7 12-14 ALL can be used to select all partitions.  <i>Note:</i> The base partition is zero.
Start Time and Date	The starting range (time and date) for the log messages to be included.
End Time and Date	The end range (time and date) for the log messages. Messages occurring after this date/time will not be included.

Perform the steps below to select a log.

## Step 9-6: Selecting a log

1. Access the Diagnostics menu.
2. Enter *l* to display the Logs screen.  
  
The system automatically selects the System log, which is the default.
3. Press the Options function key.  
  
The system displays the logs available for selection.
4. Select a log (choices are System log, Maintenance log, Install log, Backup log, or Restore log) and press Return.

## Viewing a log

The user can view the selected log by using the commands menu to invoke the View command. The system log allows for date and time to be entered, and only those logs within the entered date and time range will be expanded and viewed. It also allows selection of a partition or all partitions.

Perform the steps below to view a log.

### Step 9-7: Viewing a log

1. Access the Diagnostics menu.

2. Enter *l* to display the Logs screen.

The Logs screen displays.

3. Press the Options function key.

The system displays the logs available for selection.

4. Select a log and press <Return>.

5. Specify the partition(s) and start/end time ranges.

6. Press the Commands function key.

The system displays the commands available for selection.

7. Select the View command and press <Return>.

The system displays the viewer screen for the selected log.

8. Press the Exit function key to return to the Logs screen.

The system displays the Logs screen.

When viewing a log, the user has the capability to perform a search on a string or expression contained in the log by pressing the Search key. When search is selected a pop-up window appears which allows the user to enter the following information:

- the string or regular expression to search for
- whether or not the search should be case sensitive (case insensitive is the default)
- whether or not the user wishes to do a text search or a regular expression search (text search is the default)
- the search option (these include search forward from cursor, search backward from cursor, search forward from top of file (default), and search backward from bottom of file)

The commands available when using the search option are Abort (default) and Search. Abort returns the user to the log viewer screen and no search is performed. The Search command initiates the search with the parameters the user specified. After a search has been done, the Search Again key is activated in the log viewer screen. This option allows the user to continue the previously performed search.

### Monitoring a log

The Monitor command allows the user to monitor the system log and the maintenance log as messages are received. If the CC MIS system has discontinued logging due to the file size restrictions, this command will allow the user to view the log messages that are being generated, but the messages will not be logged in the system log file.

Note: The Monitor command will be available only if the selected log is the system log or maintenance log.

Perform the steps below to monitor a log.

## Step 9-8: Monitoring a log

1. Access the Diagnostics menu.
2. Enter *l* to display the Logs screen.

The Logs screen displays.

3. Press the Options function key.

The system displays the logs available for selection.

4. Select either the System log or Maintenance log and press <Return>.

5. Press the Commands function key.

The system displays the commands available for selection.

6. Select the Monitor command and press Return.

The system displays the Monitor screen for the selected log (either the System log or the Maintenance log).

7. Press the <CTRL>C key to return to the Logs screen.

The system displays the Logs screen.

## Printing a log

The Print command will print the selected log. If date and time filtering or partition has been selected on the System log, then only those messages within the entered date and time range will be printed. This command will be available only if the maintenance printer has been configured. Perform the steps below to print a log.

### Step 9-9: Printing a log

1. Access the Diagnostics menu.
2. Enter *l* to display the Logs screen.

The Logs screen displays.

3. Press the Options function key.

The system displays the logs available for selection.

4. Select a log and press <Return>.

5. Press the Commands key.

The system displays the commands available for selection.

6. Select the Print command and press <Return>.

The system sends the selected log to the maintenance printer.

## Cancelling the log printout

The Cancel Printing command cancels a previously requested log printout. Perform the steps below to cancel a log printout.

### Step 9-10: Cancelling a log printout

1. Access the Diagnostics menu.
2. Enter *l* to display the Logs screen.

The Logs screen displays.

3. Press the Commands key.

The system displays the commands available for selection.

4. Select the Cancel Printing command and press <Return>.

The system cancels the print job currently in progress.

### View system monitor

The View System Monitor screen is comprised of up to seven status screens (depending on type of partition): Program, Lock, Partition, Physical Node, Virtual Node, Port, and CPU Utilization. The View System Monitor screen is selected from the Diagnostics menu.

The Program, Lock, Partition, Port, and CPU Utilization status screens are accessed on the system monitor screen by means of a Commands menu. Pressing a function key (PF1 or PF2 - depending on terminal type) displays the Commands menu. When a status screen is selected, the system monitor screen is redrawn with the selected status.

The Set refresh rate command is selected from the Commands menu and allows the user to select how often the system monitor should update its real-time information. Valid refresh rates are 1-60 seconds in one-second increments. The default is five seconds.

Figure 9.6 Program Status screen with Commands menu

SYSTEM MONITOR - PROGRAM STATUS										06:38:40	
PROGRAM	CL	FLAGS	STATE	USER	SERVICE ID	REQUESTOR	PRIO	SANIT*			
0	cfgmgr	S	-----t	Run	000.14038		TS20	2:00			
1	dmslink	T	MAS----dn--t	Run	000.14042	000.14038	RT10	2:00			
2	Commands			t							
3	1. Exit System Monitor			t	Run	000.14039		TS20	2:00		
4	2. Program status			t	Run	000.18281	000.14039	TS10	2:15		
5	3. Lock status			t	Run	000.14044	000.14038	TS20	2:15		
6	4. Partition status			t	Run	000.14100	000.14038	TS20	2:00		
7	5. Physical node status			t	Run	003.14062		TS25	2:00		
8	6. Virtual node status			t	Run	003.14063		RT15	2:00		
9	7. Port status			t	Run	003.14064		TS25	2:00		
10	8. CPU utilization			t	Run	003.14065		TS20	2:00		
11	9. Set refresh rate			t	Run	003.14066		TS20	2:00		
12				t							
13	winserver	T	-----t	Run	3300	003.14082		TS20	2:00		
14	wallboard	T	-----t								
15	rptgen	T	-----t								

PRTN TYP: BASE	STRT PRIO: TS10	TRNS CLASS: None	LSTN PRT:
ARGS: -n			

F12=Help F1=Select no command

### Program status

The Program Status screen is the first screen displayed when the View System Monitor command is selected on the Diagnostics.

## Step 9-11: Accessing the View System Monitor screen

1. Access the Diagnostics menu.
2. Enter *v* to display the View System Monitor screen.

The Program Status is displayed as the default setting. To change the view, select the desired option from the commands menu.

The table below defines the program status screen fields.

**Table 9-2: Program status screen fields**

Parameter	Description
Program Name	The name of the program.
CL	(Class) "S" is used to represent static (meaning that the program never goes away) and "T" for transient (meaning the program only appears when requested).

**Table 9-2: Program status screen fields**

Parameter	Description	
Flags	The status flags are listed below (in order from left to right). The "-" indicates the flag is turned off or is reserved.	
	No. Char	Description
	1. M	The program is the current master time source.
	2. A	The program has acquired a source of reliable time.
	3. S	The program is a potential source of reliable time.
	4. T	Program is sensitive to abrupt time change.
	5. 2	If the "n" flag (described below) is set, the program which requested this program will be sent a USR2 signal when this program dies.
	6. 1	If the "n" flag (described below) is set, the program which requested this program will be sent a USR1 signal when this program dies.
	7. c	There is a socket connection between this program and the program which requested it.
	8. d	The program will be terminated if the program requesting it dies.
	9. n	The program which requested this program will be notified when this program dies.
	10. x	The program is performing processing during which its normal sanity period has been extended.
	11. s	The program is suspended (only applicable for static programs).
12. t	This is the template for this program.	

Table 9-2: Program status screen fields

Parameter	Description
State	Indicates current state of program. Valid states are:  Run - Program is running Ready - Ready to run Init - Initialized KillP - Kill is pending Dying - System is killing program
User ID	The user ID of the user using the program.
Service ID	The ID assigned to each program. Format is <partition ID>.<process ID>
Requestor	The service ID of the program requesting this program.
PRIO	Indicates the priority at which the program is running. The format is <priority type> <priority number>. Valid priority types are TS (time share) and RT (real time). Processes with lower priority numbers are given higher priority. This column is blank for transient programs that have not been started.
Sanity	Indicates the amount of time left before a program must report sanity again. Programs that do not report within the Sanity time are killed.
<b>Lower Portion of Screen</b>	
Partition Type	Partition type. A "BASE" program serves all partitions. A "CUST" program is an invocation of a program for a particular partition.
Start Prio	Start priority. The priority with which the program was or will be started.
Transient Class	Transient class. The program's transient class (USERS, REPORTS, PCWALLBOARDS, or None).
Args	The arguments that were passed to the program when it was started.



### Lock status

The Lock Status option is selected from the Commands menu. The system monitor screen is redrawn to display Lock Status.

Figure 9.7 Lock Status screen

SYSTEM MONITOR - LOCK STATUS						14:19:33	
	PARTITION	LOCK NAME	TYPE	MAX	STATUS	GR	WT
0	0:BASE	TAPE_IOCTL	Database		Unlocked		
1	0:BASE	AGER	Resource	1	Unlocked		
2	1:CUST	SYSDB	Database		Unlocked		
3	1:CUST	HDB_AGED	Database		Unlocked		
4	1:CUST	HDB_CUR	Database		Unlocked		
5	1:CUST	CIDUMP	Resource	1	Unlocked		
6	1:CUST	RPTCONTROL	Resource	3	Unlocked		
7	1:CUST	GRAPH	Resource	1	Unlocked		
8	2:CUST	SYSDB	Database		Unlocked		
9	2:CUST	HDB_AGED	Database		Unlocked		
10	2:CUST	HDB_CUR	Database		Unlocked		
11	2:CUST	CIDUMP	Resource	1	Unlocked		
12	2:CUST	RPTCONTROL	Resource	3	Unlocked		
13	2:CUST	GRAPH	Resource	1	Unlocked		
14	3:CUST	SYSDB	Database		Unlocked		
15	3:CUST	HDB_AGED	Database		Unlocked		

GR:  
 WT:

F12=Help F1=Commands

The table defines the lock status screen fields.

Table 9-3: Lock status screen fields

Parameter	Description
Partition	Number and type of partition (Base or Cust) in the format Partn ID: BASE or CUST.
Lock Name	The name of the lock (for example, SYSDB and HBD_AGED).
Type	Type of lock (database or resource).
Max	Maximum number of locks granted on the resource. Blank indicates unlimited locks allowed.
Status	Current status states are: Unlocked Shared Exclusive
GR	Number of locks granted.

Table 9-3: Lock status screen fields

Parameter	Description
WT	<p data-bbox="922 310 1412 380">Number of programs waiting for a lock on that resource.</p> <p data-bbox="922 415 1412 619">Note: The lower portion of the screen displays additional information about the lock. GR is the list of programs that have been granted a lock. WT is a list of programs that are waiting for a lock.</p>

### Partition status

The Partition Status option is selected from the Commands menu. The system monitor screen is redrawn to display partition status.

Figure 9.8 Partition Status screen

```

SYSTEM MONITOR - PARTITION STATUS                                08:30:45
ACTIVE ---USERS---
TYPE  FLAGS  ID  PARENT  STATUS  PROGRAMS  ACTV  LIMIT  CPU TIME  CPU %
0  BASE  ----t  0  ***  Active    6        0     0  2:09.79  0.00
1  CUST  -n--t  3     0  Active    6        0     4  2:03.05  0.00
2  NAP   ----t  1     0  Active    8        1    10  4:21.12  0.00
3  CUST
4
5
6
7
8
9
10
11
12
13
Transient Program Class Information
CLASS :          REPORTS          REMOTES    PCWALLBOARDS
LIMIT :           0                0            0
ACTIVE :           0                0            0
    
```

The table below defines the Partition Status screen fields.

Table 9-4: Partition status screen fields

Parameter	Description
Type	Type of partition (Base or Cust).
Flags	Four flags are: "d" (deleting), "s" (partition stopped), "n" (partition is network accessible) and "t" (template for this partition). The "-" indicates the flag is turned off.
ID	The numeric ID of the partition.
Parent	The ID of the partition's parent partition.
Status	Three status states are: Active - Online and working Ready - Is stopped or has not been started Dying - In process of being shutdown or deleted.
Progs Active	Number of programs running in partition.

Table 9-4: Partition status screen fields

Parameter	Description
CPU Time	Total CPU time used by programs in this partition since it was created.
CPU %	Percentage of CPU time currently being used by programs in this partition. This value is updated every 2 seconds.
Transient Program Class Information	When a partition is highlighted, additional information concerning transient programs for that partition is displayed in this area.
Class	Transient class of REPORTS, USERS, or PCWALLBOARDS.
Limit	The maximum number of each transient class allowed for this partition.
Active	The count of programs of each transient class currently active.
Environment window	<p>When a partition is highlighted, additional information concerning the partition is displayed in the lower portion of the screen by selecting the [Environment] function key. An example of the information displayed about the selected partition is as follows:</p> <pre> CUSTDATA=/misdata/disk1/cust002 IPC=/mis/ipc/cust002 CUSTDB=/misdata/disk1/cust002/ sysdb ... ... </pre>

## Port status

The port status option is selected from the commands menu. The system monitor screen is redrawn to display port status.

Figure 9.9 Port Status screen

SYSTEM MONITOR - PORT STATUS						14:42:11
PORT NAME	PORTID	CONNECTS	BAD ADDR	BAD STATE	> LIMIT	
1 miswindows	20001	44	3	6	0	

F12=Help F1=Commands

The table below describes the port status screen fields.

Table 9-5: Port status screen fields

Parameter	Description
Port Name	The name of TCP port.
Port ID	The ID number of TCP port.
Connects	The number of valid connection attempts on the port since the system was brought up.
Bad Addr	The number of connection attempts on the port from unconfigured PCs.
Bad State	The number of invalid connection attempts that failed because the partition the user was attempting to connect to was not up.

**Table 9-5: Port status screen fields**

Parameter	Description
> Limit	The number of valid connection attempts where connection would have exceeded the transient program limit for the partition.

## CPU utilization status

The CPU Utilization option is selected from the Commands menu. The system monitor screen is redrawn to display CPU Utilization status.

Figure 9.10 CPU Utilization Status screen

SYSTEM MONITOR - CPU UTILIZATION								15:05:58
---PERCENTAGE UTILIZATION---								
PROGRAM NAME	SERVICE ID	KBYTES	CPU TIME	INST	LIFE	AUG	PERIOD	
0 cfgmgr	000.15469	3068	4:58.64	0.20	0.07	0.06	0:00:16	
1 dmslink	000.15474	1748	65:35.06	0.60	0.88	0.75	0:00:16	
2 dmssim	000.15478	3340	71:41.92	1.00	0.96	0.94	0:00:16	
3 barmgr	000.15470	1160	2:06.90	0.20	0.03	0.06	0:00:16	
4 bartask								
5 ddbserv	001.15480	1208	3:47.69	0.00	0.05	0.00	0:00:16	
6 stsmgr	001.15481	2040	13:55.55	0.20	0.19	0.25	0:00:16	
7 rtce	001.15482	1368	4:59.37	0.20	0.07	0.12	0:00:16	
8 cclink	001.15483	1616	12:13.52	0.20	0.16	0.31	0:00:16	
9 scheduler	001.15484	1180	3:43.36	0.00	0.05	0.00	0:00:16	
10 age								
11 winserv	001.15535	1948	2:41.71	0.00	0.04	0.00	0:00:16	
12 display								
13 win_disp	005.17127	1876	0:01.10	0.00	0.49	0.00	0:00:16	
14 wallboard	001.16117	1300	9:55.31	0.00	0.14	0.12	0:00:16	
15 rptgen								
TOTAL CPU UTILIZATION:			778:33.86	13.20	10.44	13.94	0:00:16	

F12=Help F1=Commands F4=Reset averages

The table below describes the CPU Utilization Status screen fields.

Table 9-6: CPU Utilization status fields

Parameter	Description
PROGRAM NAME	The name of the program.
SERVICE ID	The ID assigned to each program. Format is <partition ID>.<process ID>. Partition ID 0 is reserved for the base partition. This column will be blank for transient programs that have not started yet.
KBYTES	The amount of memory in kilobytes currently used by the program. This number includes attached shared memory, so the total number of KBYTES can be greater than the total number of kilobytes used by all programs in this list.
CPU TIME	Total CPU time used by the program since it was started.

Table 9-6: CPU Utilization status fields

Parameter	Description
INST PERCENTAGE	Percentage of CPU usage during the last 5 seconds.
LIFE PERCENTAGE	Percentage of CPU usage since the system was started.
AVG PERCENTAGE	Percentage of CPU usage since reset (refer to Reset averages key below).
PERIOD	<p>Time since reset (refer to Reset averages key below).</p> <p>The lower portion of the screen displays the CPU Time and Percentage Utilization values for the entire CC MIS system.</p> <p>The Reset averages key resets the PERIOD counter and the AVG PERCENTAGE counter for the program the cursor is positioned on, for the total CPU utilization, or for all programs and the total CPU utilization (depending on which is selected).</p>



### Additional System Monitor Screens

The following two screens are available from the System Monitor Commands menu when the Networking feature is enabled.

#### Physical Node Status

When the user selects “Physical Node Status” from the Commands menu, a screen similar to the following is displayed:

Figure 9.11 Physical Node Status screen

SYSTEM MONITOR - PHYSICAL NODE STATUS							10:38:46
NODE	NODE NAME	STATUS	IP ADDRESS	COMDELAY	ZONE	TIMEDIFF	
0	0 gizmo	LOCAL	47.81.160.127				
1	1 snoopy	UP	47.81.160.102	0.00ms	+480	-0.010	
2	2 prairie	UP	47.81.160.100	20.00ms	0	-0.020	
3	3 charm	UP	47.81.160.104	4.07ms	0	+0.034	
4	999 47.81.160.177	UP	47.81.160.177	0.00ms	0	+0.000	
5							
6							
7							
8							
9							
10							
11							
12							
13							
14							

NODE	RECEIVE STATISTICS	---TRANSMIT STATISTICS---
FAILURES	--GOOD-- --DUPS--	--GOOD-- --FAIL-- TIMEOUTS
0	0 0	0 0 0

F12=Help F1=Commands

#### Virtual Node Status

When the user selects “Virtual Node Status” from the Commands menu, a screen similar to the following is displayed. This screen displays information concerning the partitions (virtual nodes) that are included in the network.

Figure 9.12 Virtual Node Status screen

SYSTEM MONITOR - VIRTUAL NODE STATUS					10:44:56
NODE	PTN	TYPE	STATUS	NAME	
0	0	0	0	Local	
1	3	0	1	Remote	
2	3	1	1	Remote Abbey-ACDSP0	
3	3	2	1	Remote Jez-Training	
4	3	3	1	Remote Steve - ACDSP1	
5	3	4	2	Remote Sonja's NAP	
6	2	5	2	Remote BigNet	
7	2	8	1	Remote local7	
8	2	9	1	Remote local8	
9	2	10	2	Remote nap2	
10	1	3	2	Remote Volatile Nap	
11	1	4	1	Remote Jez	
12	2	0	0	Remote	
13	2	1	1	Remote Steve-ACDSP0	
14	2	2	1	Remote Abbey-ACDSP1	
15	2	3	1	Remote Gayle - ACDSP21	
16	1	0	0	Remote	
17	1	1	1	Remote Partition 1	
18	1	5	1	Remote Minheng	

F12=Help F1=Commands

## Resetting the modem port

The Reset Modem Port command allows the user to reset the maintenance modem and kill any processes that may be running on the modem port. This command determines which port on the system is configured as the modem port.

If a dialup device does exist, the system then checks to see if it is in use. If the modem does not appear to be in use, then any processes running on the port are killed and the modem is reset. If the modem appears to be in use, the system prompts the user to confirm that the modem should be reset. If the user responds positively, the Reset Modem Port command will then kill all processes running on that port and reset the modem.

Perform the steps below to reset the modem port.

### Step 9-12: Resetting a modem port

1. Access the Diagnostics menu.
2. Enter *r* to reset the modem port.

The system checks to see if a dialup device exists, and if it is in use. If it does not appear to be in use, then any processes running on the port are killed and the modem is reset.

If the modem is being used, the system displays the following message:

**There appears to be someone connected to the dialup modem.  
Resetting the modem will disconnect the user without warning.  
Are you sure you want to Reset the Dialup Modem? (y/n)**

3. Enter *y* to reset the modem.

The system kills all processes running on that port and resets the modem.

Note: If the user enters *n*, the Diagnostics menu reappears.

## Link trace

The Link Trace command is used to capture the messages that are being sent between the ACD switch and the CC MIS system for debugging purposes. The output from Link Trace is a useful diagnostic tool when trying to determine the interactions between the ACD switch and the down stream processor.



The Link Trace command can capture the initialization data received from the host switch in a Link Trace file. When Link Trace is started and stopped, the on or off state is written to a file that CC MIS can check upon startup. If Link Trace is on when CC MIS is started, the system can immediately begin the Link Trace and the initialization data is captured and can be analyzed.

The figure below shows the Link Trace screen. A prompt is displayed to allow the user to specify the link for which tracing is desired.

Figure 9.13 Link Trace screen (multiple links)

---

```
Link Trace ...

There are multiple links configured:

Link Number: 1, Simulator Link
Link Number: 2, Simulator Link
Link Number: 3, Switch X.121 Addr: 12345678, ACD Pool: ACDPOOL5
Link Number: 4, Switch X.121 Addr: 12345678, ACD Pool: ACDPOOL1

Enter link number to continue or "q" to quit: █
```

---



The commands listed on the Link Trace screen relate to the link displayed the title.

When multiple links have been defined, a prompt is displayed requesting selection of the link on which the link trace commands are to operate.

The figure above shows the prompt that is displayed the first time the Link Trace command is selected. The Select Different Link command on the Link Trace menu (shown below) is used to select a different link for the link trace commands.

Figure 9.14 CC MIS Link Trace menu screen

```

Call Center MIS Link Trace (Link Number 2)
Release

Start Link Trace
View Link Trace
View Translated Link Trace
Print Link Trace
Print Translated Link Trace
Select Different Link
Help
Quit to the Previous Menu

Press s,v,ut,p,pt,l,h or q and RETURN: █

```

The View Translated Link Trace and Print Translated Link Trace commands allow the user to choose which types of messages will be translated from their hexadecimal representation to a readable format. The figure below is an example of the Message Translator Filter screen.

Figure 9.15 CC MIS Message Translator Filter screen

```

Message Translator Filter

× 1 dspAssociatePool           × 15 switchEndOfInit
× 2 dspRequestInit            × 16 switchSendEvent
× 3 dspStopInit               × 17 switchSendLoadMgmtEvent
× 4 dspQueryDateAndTod        × 18 switchSendThrottle
× 5 dspStartTransfer           × 22 switchSendAudioList
× 6 dspStopTransfer           × 23 switchSendRouteList
× 8 dspRequestLoadMgmt        × 24 switchSendNACDGroupRoutingData
× 9 dspRequestAudioInfo       × 25 switchSendSubgroupData
× 10 dspRequestRouteInfo      × 26 switchSendUFGData
× 11 switchSendSubPoolData    × 27 switchSendUFGOm
× 12 switchSendAcidGroupData  × 64 nosLogon
× 13 switchSendSupplAcidDn    × 65 nosLogout
× 14 switchSendAgentPosData

Set (*) Translation of All Operations   Set Agent Filter
Clear Translation of All Operations     Set Position Filter
Proceed (View)                          Set Group Filter
Help

Quit to Previous Screen

Enter Operation IDs (to toggle),s,c,p,h,a,o,g or q:

```

When Link Trace translating is turned on, the hexadecimal notation in the Link Trace file is interpreted into a readable format. The translated version of Link Trace can be used if a protocol guide is not available to interpret the hexadecimal file. The figure below is an example of the untranslated Link Trace file.

Figure 9.16 Untranslated Link Trace file example

```

30 93/06/10
dsp - 10:18:01 a1 23 30 21 02 01 0b 02 01 40 30 19 16 04 4e 4f 50 31 16 06
              41 43 44 4d 49 53 16 06 41 43 44 4d 49 53 02 01 07
dsp - 10:18:01 a1 0a 30 08 02 01 0c 02 01 41 05 00
swx - 10:18:01 a3 10 30 0e 02 01 0b 02 01 41 30 06 02 01 02 02 01 00
dsp - 10:18:03 a1 23 30 21 02 01 0d 02 01 40 30 19 16 04 4e 4f 50 31 16 06
              41 43 44 4d 49 53 16 06 41 43 44 4d 49 53 02 01 07
swx - 10:18:02 a2 07 30 05 02 01 0c 05 00

```

The figure below is an example of the same messages in their translated form.

Figure 9.17 Translated Link Trace file example

```

BCS : 30 Date : 93/06/10

1)   dsp 10:18:01   InvokedID:  11 Invoke nosLogon
      Protocol Version: NOP1
      Userid:        ACDMIS
      Password:      ACDMIS
      Profile:       7

2)   dsp 10:18:01   InvokedID:  12 Invoke nosLogout

3)   swx 10:18:01   InvokedID:  11 Ret Err on nosLogon

      Operation Sequence Error, duplicatelogon (2) :
      The nosLogon RO is in error since an RO of this type is already in
      effect.

```

In the figures above, messages marked by dsp are messages sent from the downstream processor (CC MIS) to the ACD host switch. Those marked with swx are messages sent from the ACD host switch to the downstream processor. The InvokedID acts as a sequence number that associates individual operation invocations with operation results.

### Starting / Stopping the link trace

The Start Link Trace command is a toggle command that allows Link Trace to be turned on and off. When Link Trace is turned on, the displayed command is Stop Link Trace. Perform the steps below to use the Start/Stop Link Trace command.

#### Step 9-13: Starting/stopping link trace

1. Access the Diagnostics menu.
2. Enter *t* to access the Link Trace screen.

The Link Trace screen displays.

3. Enter the link number.
4. Press *s* and <Return>.

The system turns Link Trace on.

Note: If Link Trace is on, the Link Trace screen displays the Stop Link Trace command instead of Start Link Trace. In order to stop the link trace once it has been activated, the user again presses *s* and <Return>.

### Viewing the link trace

The View Link Trace command allows the user to view the untranslated hexadecimal Link Trace file. Perform the steps below to use the View Link Trace command.



The View Link Trace command is available only if a trace file exists.

#### Step 9-14: Starting/stopping link trace

1. Access the Diagnostics menu.
2. Enter *t* to access the Link Trace screen.

The Link Trace screen displays.

3. Press *v* and Return.

The system displays the untranslated hexadecimal Link Trace file.

## Viewing the translated link trace

The View Translated Link Trace command allows the user to view the translated version of the Link Trace file, instead of the hexadecimal file. When this command is chosen, the Message Translator Filter screen appears. This screen allows the user to choose which messages will be translated for viewing.

Perform the steps below to use the View Translated Link Trace command.



This command is available only if a Link Trace file exists.

## Step 9-15: Viewing a translated link trace file

1. Access the Diagnostics menu.
2. Enter *t* to access the Link Trace screen.

The Link Trace screen displays.

3. Press *vt* and <Return>.

The system displays the Message Translator Filter screen.

4. Enter *p* to proceed with the view command.

The system displays the translated Link Trace file.

## Using the Search function

The Search command allows you to search for a specific entry within the link trace file.

Figure 9.18 Search function key

```

-[Line      1 of      1]_____
 F1=Exit  F4=Search
  
```

Pressing the Search function key causes the Search screen to be displayed. The Search screen is shown in the figure below.





### Printing the link trace

The Print Link Trace command allows the user to print the untranslated hexadecimal Link Trace file.

Perform the steps below to use the Print Link Trace command.



This command is only available if a trace file exists and the maintenance printer has been configured.

## Step 9-16: Printing a link trace file

1. Access the Diagnostics menu.
2. Enter *t* to access the Link Trace screen.

The Link Trace screen displays.

3. Press *p* and <Return>.

The system sends the current Link Trace file to the maintenance printer.

### Printing the translated link trace

The Print Translated Link Trace command prints the translated Link Trace file, rather than the untranslated hexadecimal file. When this command is chosen, the Message Translator Filter screen will appear. This screen will allow the user to choose which messages will be translated and printed.

Perform the steps below to use the Print Translated Link Trace command.



This command is available only if a Link Trace file exists and the maintenance printer has been set.

## Step 9-17: Printing a translated link trace file

1. Access the Diagnostics menu.
2. Enter *t* to access the Link Trace screen.

The Link Trace screen displays.

3. Press *pt* and <Return>.

The system displays the Message Translator Filter screen.

4. Enter *p* to proceed with the print command.

The system sends the translated Link Trace file to the maintenance printer.

### Canceling link trace printing

The Cancel Printing command cancels printing of the Link Trace file if it is currently being printed.

Perform the steps below to use the Cancel Printing command.



The Cancel Printing command is available only if a Link Trace file has been printed.

## Step 9-18: Cancelling link trace printing

1. Access the Diagnostics menu.
2. Enter *t* to access the Link Trace screen.

The Link Trace screen displays.

3. Press *c* and <Return>.

The system cancels the current Link Trace print job.

### Select different link

The Select Different Link command allows you to select a different link for the trace commands.

Perform the steps below to use the Select Different Link command.

### **Step 9-19: Selecting a different link for link trace**

1. Access the Link Trace screen.
2. Press *l* and <Return>.

The system displays a Link Trace window.

3. Enter the new link number.

The Link Trace menu screen is displayed.

## TCP / IP Switch Link Diagnostics

The Switch Link Diagnostics screen shows the status of the selected link. (Links are selected from the Options menu using the Options key.)

Figure 9.21 TCP / IP Switch Link Diagnostics

```
TCP/IP Switch Link Check ...

There are multiple TCP/IP switch links configured:

Link 2: TCP/IP - IP Address   : 47.0.16.200:30000      ACD Pool: SIMPOOL
Link 3: TCP/IP - IP Address   : 47.104.136.181:15000     ACD Pool: ACDPOOL2
Link 4: TCP/IP - IP Address   : 47.104.48.37:21006      ACD Pool: SIMPOOL

Enter link number to continue or "q" to quit:
```

### Checking a switch link

The TCP/IP Switch Link Diagnostics command allows you to see if the link is operational. The system sends a call packet across the specified link and reports any problems that occur. The system displays any error messages.

Perform the steps below to check a switch link.

### Step 9-20: Checking a TCP / IP link

1. Access the Diagnostics screen.
2. Enter *s* to select TCP/IP Switch Link Diagnostics.  
  
The Link Diagnostics screen is displayed.
3. Select the link to be checked by entering the link number

## X.25 Diagnostics

The X.25 Diagnostics screen shows the status of the selected X.25 link. (Links are selected from the Options menu using the Options key.) The figure below shows the X.25 screen with the commands available on the Commands menu.

Figure 9.22 CC MIS X.25 Diagnostics screen (with Commands menu)

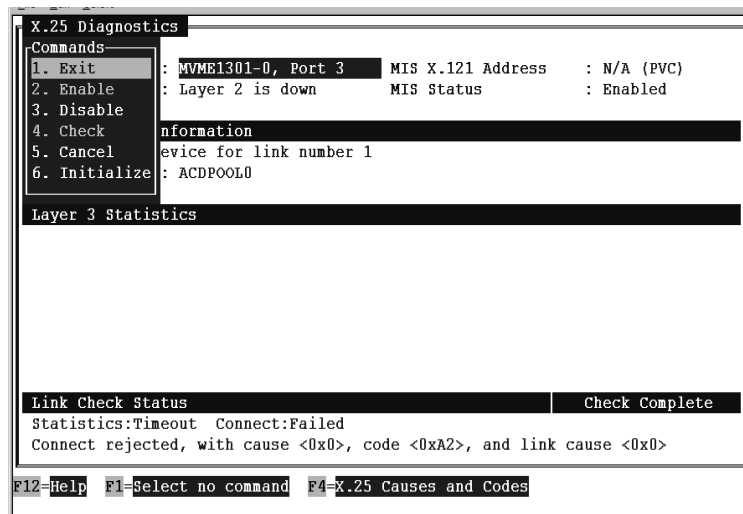

### Checking an X.25 link

The Check X.25 Link command allows you to see if the X.25 link is operational. The system sends a call packet across the specified X.25 link and reports any problems that occur. The system displays any error messages.

Perform the steps below to check an X.25 link.

### Step 9-21: Checking an X.25 link

1. Access the Diagnostics screen.
2. Enter x to select X.25 Diagnostics.
  - The X.25 Diagnostics screen is displayed.
3. Select the X.25 device to be checked using the [Options] key
4. Press the Commands function key.
  - The system displays the Commands menu.
5. Select the Check option and press <Return>.

### Disabling an X.25 link

The Disable X.25 Link command disables an X.25 link to prevent CC MIS from attempting to connect to the switch using that link. This allows you to perform maintenance on the X.25 link.

Perform the steps below to disable an X.25 link.

#### Step 9-22: Disabling an X.25 link

1. Access the X.25 Diagnostics screen.
2. Highlight the link to be disabled.
3. Press the Commands function key.

The system displays the Commands menu.

4. Select the Disable option and press <Return>.

### Enabling an X.25 link

The X.25 Link command enables an X.25 link so that CC MIS can connect to the switch using that link. This allows you to bring a link into service after it has been disabled.

Perform the steps below to enable an X.25 link.

#### Step 9-23: Enabling an X.25 link

1. Access the X.25 Diagnostics screen.
2. Highlight the link to be enabled.
3. Press the Commands function key.

The system displays the Commands menu.

4. Select the Enable option and press <Return>.

### Cancel X.25 link check

The cancel command cancels the link checking of an X.25 link.

Perform the steps below to cancel the X.25 link checking.

## Step 9-24: Cancelling an X.25 link check

1. Access the X.25 Diagnostics screen.
2. Press the Commands function key.  
The system displays the Commands menu.
3. Select the Cancel option and press <Return>.

### Initializing an X.25 link

The Initialize command initializes the X.25 card associated with an X.25 device.



On 88K-based platforms this command initializes all of the devices (ports) on the affected card, not just the selected device.

On the PowerPC this command initializes only the selected device - not the entire card.

## Physical Network Login

The physical network login option is available on the Diagnostics menu when the networking feature is enabled. Selection of this option causes the screen shown in the figure below to be displayed. This screen provides access to other nodes in your physical network.

Figure 9.23 Physical Network Login screen

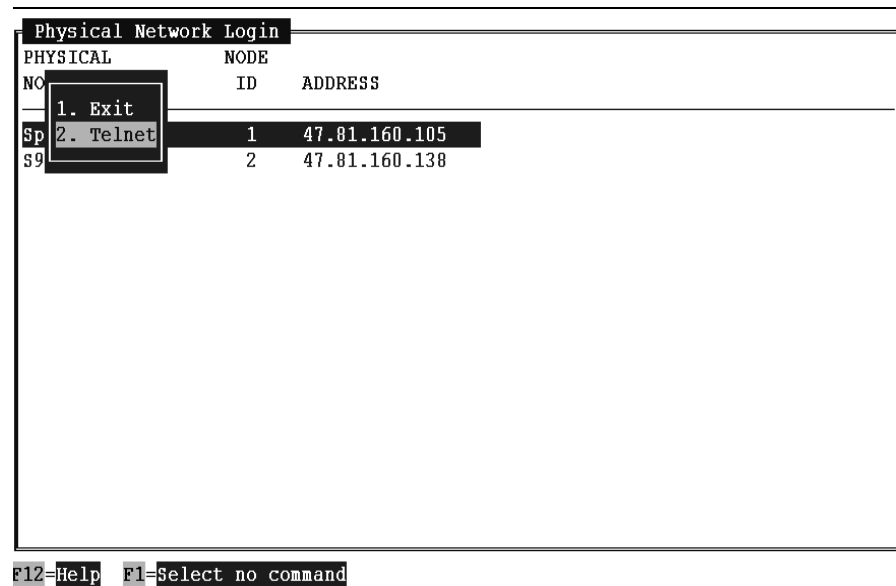

## Step 9-25: Physical network login screen

To login to a physical node on the network,

1. Use the arrow keys to highlight the desired node, then press the Commands function key.
2. A commands menu is displayed allowing you to exit or login through Telnet.
3. Select the Telnet option. The login prompt is displayed.

```
*** To terminate login process:
***   if a login or password prompt is displayed, press Control-D
***   if a login or password prompt is not displayed, press Control-C

Trying 47.81.160.105...
Connected to 47.81.160.105.
Escape character is '^]'.

UNIX(r) System V/88 Release 4.0 (carpyb) (pts/9)

login:
```

4. Enter login information.



# Section 10: Configuration Updates

# 10

 *Accessing the Run State Utilities menu*

 *Viewing the Configuration update screen*

 *Running a configuration update*

## Introduction

Prior to CC MIS Release 3.0, the Configuration Update command was available in the Supervisor Interface. In the current release, this command is in the Maintenance Interface and is accessed from the Run State Utilities menu. The name of the command has been changed to Update Switch Configuration Data.

The Run State Utilities menu is shown in the figure below. The prompt screen asking for the link on which to request the configuration update is shown in the figure below.

Figure 0.1 Run State Utilities menu

```
Call Center MIS Run State Utilities [Spin]
Release 5.0.0.BNR.19

Update Switch Configuration Data
Partition Startup and Shutdown
Shutdown the CC MIS System
Power Down
Help
Quit to the Previous Menu

Press u,p,s,d,h or q and RETURN: █
```

CC MIS uses this command to get update information from the switch to update its internal data. To run a configuration update, select the Update Switch Configuration Data command from the Run State Utilities menu.

## Step 10-1: Accessing the configuration update screen

1. Enter *r* on the Maintenance and Admin main menu to select Run State Utilities.

The system displays the Run State Utilities menu.

2. Enter *u* on the Run State Utilities menu to select the Update Switch Configuration Data command.

The system displays the Configuration update screen.

The figure below is an example of the prompt for multiple links. Enter the link number of the link to be updated.



Re-initialization of a link affects only partitions using that link.

Figure 0.2 Configuration update prompt screen (multiple links)

```
Update Switch Configuration . . .  
The following switch links are active:  
Link Number: 1, Switch X.121 Addr: 12345678, ACD Pool: POOL1  
Link Number: 3, Switch X.121 Addr: 12345678, ACD Pool: POOL3  
  
Enter link number to continue or "q" to quit: 3  
Requesting configuration update on link 3 . . .  
  
Press RETURN to continue
```

The figure below is an example of the prompt for a single link. Enter “y” to continue or “n” to quit.

Figure 0.3 Configuration update prompt screen (single link)

```

Update Switch Configuration . . .

The following switch link is active:

    Link Number: 1, Switch X.121 Addr: 12345678, ACD Pool: POOL1

Enter “y” to continue or “q” to quit: y
Requesting configuration update on link 1 . . .

Press RETURN to continue
  
```

Use the steps below to run a configuration update.

## Step 10-2: Running a configuration update

### For single link:

1. From the Configuration update screen, enter:
  - a. *y* to run the configuration update for the specified link(s)
  - or-
  - b. *q* to quit without running the update.

### For multiple links:

1. From the Configuration update screen, enter:
  - a. the number of the desired link for the update and press <RETURN> to run the update.
  - or-
  - b. *q* to quit without running the update.



# Section 11: CC MIS software upgrades

# 11



*Performing a software upgrade (3.x or 4.x to 5.0)*



*Installing Keycodes*

## Introduction

The Load New Software Version command upgrades CC MIS software from a software distribution tape. This procedure is used to upgrade Release 3.1 (or later) or 4.0 (or later) to 5.x release. This procedure preserves the databases so that no supervisor, agent, configuration, or historical data is lost.

The Load New Software Version command is accessed by selecting the System Upgrade Utilities command on the Maintenance main menu, then selecting the Load New Software Version command. The System Upgrade Utilities screen is shown in the figure below.

Figure 11.1 System Upgrade Utilities menu

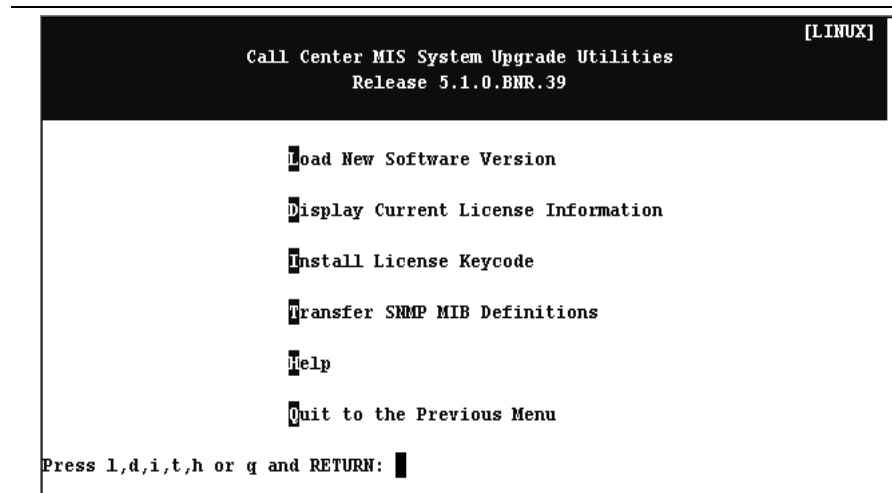

## Software upgrades

Do not use this utility to upgrade the UNIX operating system. This utility is only used for loading new CC MIS software releases (for example 4.x to 5.x) from a software distribution tape. This utility is not used to upgrade the software from 1.x or 2.x to 3.x.

### Load new software version

The Load New Software Version command shuts down CC MIS and upgrades the version of the software.

Perform the steps in Procedure 11-1 to load a new CC MIS software release. You must be running a Release 3.x version of CC MIS to use this procedure. This procedure is used to load a new version of the software (for example, 4.1 to 5.0). To upgrade from 2.x to 3.x, refer to Chapter 2.

It is highly recommended that a software upgrade should be performed by installation engineers. CC MIS supervisors and system administrators should not upgrade CC MIS software.



If it is desired that a particular partition not be started after loading the new software version, that partition should be stopped prior to loading the new version. After the new version is loaded, the CC MIS will automatically restart and partitions will return to their last state (running or stopped).

## Step 11-1: Load new CC MIS software version

1. Run a complete backup (refer to Chapter 5).

Note: If you are running Release 3.x under an earlier version of NTOS 2.x (for example, 2.4) and you choose to install the latest version of NTOS 2.x (for example 2.6), AFTER the backup is completed, you must perform the following sub-steps prior to proceeding to step 2 in this procedure. The sub-steps are as follows:

- a. After the backup is completed, install the new NTOS 2.x version (see Appendix C).
  - b. Re-Install your current Release 3.x.
  - c. Restore the backup Release 3.x data. (After the data is restored and the Maintenance menu is displayed, proceed to step 2.)
2. Access the System Upgrade Utility Menu.
  3. Enter / to load a new software release.

The system displays the following message:

### Upgrade to a new version of CC MIS.

This option will perform the following actions:

- Shutdown CC MIS
- Install the new CC MIS software from the distribution tape
- Restart the CC MIS system

**WARNING - It is strongly suggested that a full backup be completed before doing a software upgrade.**

**To perform a backup, enter "n" at the following prompt, then run an ad hoc backup from the Backup screen under the Backup and Restore Utilities menu. Be sure to select all items for backup and WAIT FOR THE BACKUP TO COMPLETE.**

**To continue with the upgrade and not perform backup, enter "y" at the following prompt.**

**Do you wish to continue? (yes/no):**

4. Enter *y* to continue with the procedure or press *n* if you want to quit the software upgrade.

Note: If your system contains both the DAT and cartridge tape drives, refer to the note in the margin.

5. The system displays the following message:

**Please insert the tape containing the new CC MIS software. Please wait until the tape drive is ready before answering.**

**Ready? (yes/quit)**

Continued on next page...

### Systems with both DAT and Cartridge tape drives

If your system has two tape drives, the following message is displayed when *y* is entered in step 4.

This system has both a cartridge and a DAT tape drive. The cartridge tape drive is the larger of the two. Please select the tape drive that contains the CC MIS software upgrade as follows:

- c - Selects the CARTRIDGE tape drive.
- d - Selects the DAT tape drive.

Upgrade CC MIS from which drive? (cartridge/dat/quit)

This prompt is displayed only when the system has both a CARTRIDGE and DAT tape drives. If the system has only one tape device, the prompt is not displayed and no user selection of the drive is required.

Type *c* to select CARTRIDGE tape or type *d* to select the DAT tape drive. Continue at step 5.

## Step 11-1 - Continued

Insert the tape in the tape drive and enter *y* to load the new software.  
(Enter *q* if you want to abort the software upgrade.)

**Verifying contents of tape ...**  
**Tape verified as a valid CC MIS installation tape.**  
**Shutting down Call Center MIS ...**  
**Call Center MIS has been shut down.**

6. If there are no reports in the queue, go to step 7. If there are reports in queue, the system displays the following message:

**There are still reports queued to be printed. A software upgrade at this time will cause these reports to be cancelled.**  
**Do you wish to continue? (yes/no):**

7. Enter *y* to continue with the upgrade or enter *n* to quit the software upgrade.

The system displays the following message:  
**Shutting down Call Center MIS error logging.**  
**Call Center MIS error logging has been shut down.**  
**Extracting files from tape...**

8. Regardless of the entry in step 7, the system continues with the upgrade and the following messages are displayed:

**Extraction of files from tape completed.**

**CC MIS Release 5.X Installation**  
**The CC MIS installation tape may now be removed from the tape drive and stored in a secure place.**

9. Remove the tape and store it in a secure place.  
The system will continue displaying messages.

**A license keycode must be installed before the CC MIS system can be started. The license keycode enables the options that were purchased for use on this system. You must have a keycode that was generated specifically for this system which has the serial number listed below:**

**System Serial Number:            (for example 336D05E2)**

**Do you wish to install a keycode at this time? (yes/no) *y***

**You must supply the keycode you received to activate the options / capacities you purchased. The keycode consists of five blocks of four characters.**

**Note: You must type the keycode EXACTLY as you received it.**  
**The case of the letters in the keycode is important.**

Continued on next page...



## Step 11-1 - Continued

---

Once entered, the keycode will be validated and the features enabled by it will be displayed, allowing you to confirm that the keycode was entered correctly.

XXXX XXXX XXXX XXXX XXXX

Enter the keycode: *ABDC 555D EFGH IJ99 ATX9* (sample only)

10. The system will now display the serial number, keycode, and customer ID, all of the options and capacities that have been purchased and enabled for your system. Review the options, then type y at the "Are these options correct?" prompt.
  11. Press RETURN to continue.
  12. After the loading of the new version is complete, the CC MIS system will automatically start and all partitions that were running prior to loading the new version will be returned to their running state.
-

## Installing a New Keycode on CC MIS 5.0 System

Nortel Networks CCMIS system uses a keycode to enable options within the CCMIS application. Use the following procedure to install and activate your new keycode.

1. Login into the CCMIS Maintenance and Administration terminal
2. From the Main Menu, type 'S' to select the 'System Upgrade Utilities'.

Figure 11.2 Install License Keycode

```
Call Center MIS System Upgrade Utilities [Spin]
Release 5.0.0.BNR.19

Load New Software Version
Display Current License Information
Install License Keycode
Transfer SNMP MIB Definitions
Help
Quit to the Previous Menu

Press l,d,i,t,h or q and RETURN:
```

3. From the System Upgrade Utilities Menu type 'I' to select 'Install License Keycode'.
4. The following screen appears:

Figure 11.3 System Serial Number

```
Install new license keycode on this CC MIS system
WARNING:
This procedure requires that you have purchased a keycode
to enable the desired features and capacities and that this
this keycode was generated specifically for this CC MIS
system which has the serial number listed below:

System Serial Number: 336D05E2

Do you wish to proceed? (yes/no) Y
```

5. Type Y and press Return.

6. The screen shown below appears.

Figure 11.4 Entering Keycode

```

WARNING:

This procedure requires that you have purchased a keycode
to enable the desired features and capacities and that this
this keycode was generated specifically for this CC MIS
system which has the serial number listed below:

System Serial Number: 336D05E2

Do you wish to proceed? (yes/no) Y

You must now supply the keycode you received to activate the
new features/capacities you purchased. This keycode consists
of five blocks of four characters.

Note: You must type the keycode EXACTLY as you received it.
The case of the letters in the keycode is important.

Once entered, the keycode will be validated and the features
enabled by it will be displayed, allowing you to confirm
that the keycode was entered correctly.

XXXXXXXXXX XXXX XXXX XXXX XXXX XXXX
Enter the new keycode: █

```

7. Enter the Keycode exactly as it appears on the keycode sheet.

8. The following screen is displayed

Figure 11.5 Confirm Settings

```

Enter the new keycode: LXFW 307C KGRP WJ73 ATX2

The new features/capacities are:

System Serial Number      : 336D05E2
License Keycode           : LXFW 307C KGRP WJ73 ATX2
Customer Identification Number : 4215

Link Redundancy           : ENABLED
Data Export               : ENABLED
Language Support          : ENABLED
Auto. Position Reassignment : ENABLED
SNMP Support              : ENABLED
Flexible Intervals        : ENABLED
Networking                : ENABLED
Maximum ACD Groups        : 1024
Maximum Positions         : 9999
Maximum Wallboard Ports   : 64
Maximum Logins            : 256
Maximum NAPS              : 4
Maximum Local Partitions  : 16
Maximum Switch Links      : 12

Are these correct? (yes/no/quit) Y█

```

9. Verify settings and type Y, then press Return.

10. The screen shown below is displayed.

Figure 11.6 Continue Keycodes

```
Link Redundancy           : ENABLED
Data Export               : ENABLED
Language Support          : ENABLED
Auto. Position Reassignment : ENABLED
SNMP Support              : ENABLED
Flexible Intervals        : ENABLED
Networking                 : ENABLED
Maximum ACD Groups        : 1024
Maximum Positions         : 9999
Maximum Wallboard Ports   : 64
Maximum Logins            : 256
Maximum NAPS              : 4
Maximum Local Partitions  : 16
Maximum Switch Links      : 12

Are these correct? (yes/no/quit) Y

The new license keycode has been saved. It will
be activated the next time the CC MIS system is
restarted.

Press RETURN to continue █
```

11. Press Return to continue.

12. Type Q to quit at the System Upgrade Utilities menu.

**Note:** You must Shutdown and Restart CC MIS using the procedures Chapter 4 of this guide.

## Section 12: SNMP transfer

# 12

 *SNMP transfer session*

### Introduction

The Transfer SNMP MIB Definitions command on the System Upgrade Utility menu allows the transfer of the CC MIS System MIB and CC MIS Partition MIB definition files to selected Network Management Systems (NMS).



The Transfer SNMP MIB Definitions command is displayed on this menu only when the SNMP option has been enabled for the system.

Figure 12.1 System Upgrade menu

```
Call Center MIS System Upgrade Utilities [LINUX]
Release 5.1.0.BNR.39

Load New Software Version
Display Current License Information
Install License Keycode
Transfer SNMP MIB Definitions
Help
Quit to the Previous Menu

Press l,d,i,t,h or q and RETURN: █
```

## Guidelines

Perform the steps in the procedure below to access the SNMP Transfer screen.

### Step 12-1: Accessing SNMP transfer screen

1. Access the System Upgrade Utilities menu.
2. Type *t* to select the Transfer SNMP MIB Definitions command.
3. The SNMP Transfer session screen is displayed.

Figure 12.2 Sample SNMP transfer session

```
Transfer SNMP MIB definitions to a Network Management System

This procedure uses the File Transfer Protocol (FTP) to send
the CC MIS SNMP system and/or partition MIB definitions to
any computer that is accessible via the network.

Transfer which MIBs? (system/partition/all/quit) [All]
IP address of Network Management System ? [ ] 47.129.161.34
User ID? [ ] nmsadmin
Target directory? [ ] tmp

The following information has been entered:

      MIBs to be transferred . . . . . All
      IP address of NMS . . . . . 47.129.161.34
      User ID . . . . . nmsadmin
      Target directory . . . . . tmp

Is this information correct? (yes/no/quit) y

Please enter password for user "nmsadmin" on system
"47.129.161.34" :

Beginning transfer of MIB files.
  Transferring system MIB file (missys.mib) . . .
  Transferring partition 1 MIB file (misptn1.mib) . . .
Transfer of MIB files complete.

Please check for errors in the output above.
Press RETURN to continue.
```

During the SNMP transfer session, you are prompted for the following information:

- *MIBs to be transferred* - The options are to transfer just the system MIB, just the partition MIB, or both. (If the partition MIB is selected, then one MIB file will be transferred for each partition defined on the CC MIS system.)
- *IP address* - The IP address of the machine to which the files are to be transferred.
- *user ID* - The user ID on the remote machine that is to receive the MIB files.
- *target directory* - The directory in which to place the MIB definition files on the remote machine.
- *password* - The password for the specified user on the remote machine.







# Section 13: Operating System Config

# 13

*This section applies only to the AIX platform.*

 *Accessing the OS Config menu*

 *Direct changes to the OS configuration*

 *Adding a new disk*

 *Changing time zone settings*

## Changing OS configuration

The Maintenance main menu for the PowerPC platform contains the Operating System Configuration option that allows you to modify the OS configuration or to add components such as additional disks. The Maintenance main menu is shown in the figure below.

Figure 13.1 Maintenance Main Menu (PowerPC platform)

```

Call Center MIS Maintenance and Administration [LINUX]
Release 5.1.0.BNR.39

Run State Utilities
Backup and Restore Utilities
System Upgrade Utilities
Diagnostics
Modify Password
Configuration
Help
Logout

Press r,b,s,d,m,c,h or l and RETURN:

```



Use of the commands on this menu can adversely affect your system.

It is highly recommended that they be used only by trained system administrators.

Selection of the Operating System Configuration command results in the OS Configuration menu being displayed. This menu contains five commands and access to help.

The OS Configuration menu is shown in the figure below.

Figure 3.2 OS Configuration menu

```

[PowerPC1]
Call Center MIS Operating System Configuration
Release

Add a Unix Printer
Delete a Unix Printer
Add Disk(s) to System
Change Time Zone
Direct C/S Configuration
Help
Quit to the Previous Menu

Press ap,dp,ad,z,o,h or q and RETURN:

```

### Adding a Unix printer

Selecting the Add a Unix Printer command displays a screen that allows you to specify the printer to be added. The screen below is displayed. Select the desired operation.

Figure 3.3 Adding a Unix printer

```

Add a Unix Printer to the System

This procedure starts the System Management Interface Tool (smit) to step
you through the creation of a new printer queue within the operating system.
Once configured into the operating system, you can then configure the new
printer queue into CC MIS as the maintenance printer or for use by a
particular partition.

Please choose one of the following options:

Get information on:
  el - Explain the "local" attachment type
  er - Explain the "remote" attachment type
  ea - Explain the "ascii" attachment type
  eh - Explain the "hpJetDirect" attachment type
  eq - Explain queue types

Perform an operation:
  h - Add a hostname for a "remote" or "hpJetDirect" printer
  p - Add a printer queue
  q - Quit

Option?

```

#### Adding Printers on a PowerPC

Note that on the PowerPC all direct-connect or LAN printers must be configured using this screen before they can be configured into CC MIS as either a Maintenance or partition printer.

Selecting the “h” option displays a screen that allows you to specify a hostname to add to the hosts table prior to adding a network printer. The screen below is displayed. Select the Help function key for additional information and field descriptions.

Figure 3.4 Specifying the name

```

                                Add a Host Name

Type or select values in entry fields.
Press Enter AFTER making all desired changes.

                                [Entry Fields]
* INTERNET ADDRESS (dotted decimal)      []
* HOST NAME                               []
  ALIAS (ES) (if any - separated by blank space) []
  COMMENT (if any - for the host entry)      []

F1=Help          F2=Refresh          F3=Cancel          F4=List
Esc+5=Reset      F6=Command          F7=Edit           F8=Image
F9=Shell         F10=Exit             Enter=Do
    
```

Selecting the “p” option displays a screen that allows you to specify the printer to be added. The screen below is displayed. Only the local, remote, ascii, and hpJetDirect attachment types are useful for CC MIS purposes.

Figure 3.5 Adding the printer

```

                                Add a Print Queue

Move cursor to desired item and press Enter. Use arrow keys to scroll.

# ATTACHMENT TYPE      DESCRIPTION
local                   Printer Attached to Local Host
remote                  Printer Attached to Remote Host
xstation                 Printer Attached to Xstation
ascii                   Printer Attached to ASCII Terminal
hpJetDirect              Network Printer (HP JetDirect)
file                     File (in /dev directory)
other                    User Defined Backend

F1=Help          F2=Refresh          F3=Cancel
F8=Image         F10=Exit             Enter=Do
/=Find          n=Find Next
    
```

### Deleting a Unix printer

Selecting the Delete a Unix Printer command displays a screen that allows you to specify the printer to be deleted. The screen below is displayed if there are no printers defined. If printers are defined, select the printer to delete.

Figure 3.6 Delete printer screen

```
Delete a Unix Printer from the System
There are no Unix printers configured in the system!
Press RETURN to continue
```

### Adding disk(s) command

Selecting the Add Disk(s) to System command displays a screen that allows you to specify the disk(s) to be added. If no disks are available for configuration the message shown below is displayed.

Figure 3.7 Adding disk(s)

```
Add new disk(s) to the system
There are no unused disks to be installed!
Press RETURN to return to the menu
```

### Changing Time Zone settings

Selecting the Changing Time Zone command displays a screen that allows you to specify new time zone setting. The warning message shown below is displayed to allow you to abort the action prior to making any changes to the configuration.

Figure 3.8 Time Zone

---



This command changes your configuration and shuts down your system.

It is highly recommended that it be used only by trained system administrators.

---

```

Change Time Zone Settings

*****
WARNING: Changing the time zone is normally performed during
         installation of new systems only! Performing this
         operation on a system that is already in-service
         could adversely affect data that has been collected
         for the current day.
*****

This operation will perform the following actions:

- Shutdown the CC MIS system
- Run the System Management Interface Tool (smit)
  to allow you to change the time zone settings
- Reboot the entire system to pick up the changes
  to the time zone settings
- Restart the CC MIS system

Do you wish to continue? (yes/no): █

```

Typing “Y” and pressing <Return> results in the actions listed in the screen being performed. To abort this operation type “N” and press <Return>.

### Making direct changes to the OS configuration

Selecting the Direct OS Configuration command displays a screen that allows you to change any operating system parameter. The warning message shown below is displayed to allow you to abort the action prior to making any changes to the configuration.

Figure 3.9 Direct OS Configuration

---



This command is used to change your system's OS configuration.

It is highly recommended that it be used only by trained system administrators.

---

```

WARNING!!

This procedure provides direct access to ALL operating system configuration
functions and should be used with EXTREME caution. You should be familiar
with the AIX System Management Interface Tool (SMIT) and with AIX operating
system configuration concepts before attempting to use this interface.

*****
*** Incorrect use of this interface could leave ***
*** the system in a non-functional state.      ***
*****

Do you wish to continue? (yes/no): █
    
```

Typing “Y” and pressing <Return> results in the configuration screen being displayed. To abort this operation type “N” and press <Return>.

## Getting help

Selecting the Help command displays a help screen that allows you to view information about the OS Configuration menu options.

The Help screen is shown in the figure below.

Figure 3.10 Help screen

```
[ This screen displays information about the current menu. Help is
presented using the UNIX "pg" command. To get out of help press
"q". To see the next page press the space bar or RETURN. To back
up one page, press "-1" followed by RETURN. Press "h" for help with
pg. ]

This is the main menu of the CC MIS Operating System Configuration
screen. This screen lists the commands that may be run from this menu.
To run a command, press the highlighted letter (or letters) of the desired
command followed by RETURN.

The commands available from this menu are:

    Add Disk(s) to System -

        This command allows you to configure new disk drives into the
        system so that they become available for the storage of CC MIS
        data.

        Data for one or more partitions is stored on a "volume group" which
        can contain a single disk or multiple disks. Data for a single
        partition cannot span volume groups although volume groups can be
        expanded with the addition of another disk. The system is initially
        Press <space> for more
```





## Section 14: Preventive maintenance

# 14



*Suggested preventive maintenance for VMEs*



*Cleaning the DAT drive*



*Checking the filter*



*Rotating the backup tapes*

### Preventive maintenance

The CC MIS system is a low maintenance unit. However, it is recommended that the following items be checked or performed to keep the system running properly:

- Filter on the back of the unit (only on VME 8420)
- Tape rotation
- DAT head cleaning

#### Check filter

Check the filter on the back of the VME 8420 for an accumulation of dust and lint. Failure to keep the filter clean can result in VME shutdowns. (The filter can become clogged and can cause the VME to shutdown due to over temperature.)

The filter is located in the rear of the VME (as illustrated in the figure below). The filter should be checked during scheduled maintenance or cleaned as needed. The filter “snaps” off for cleaning.

Figure 4.1 Location of filter

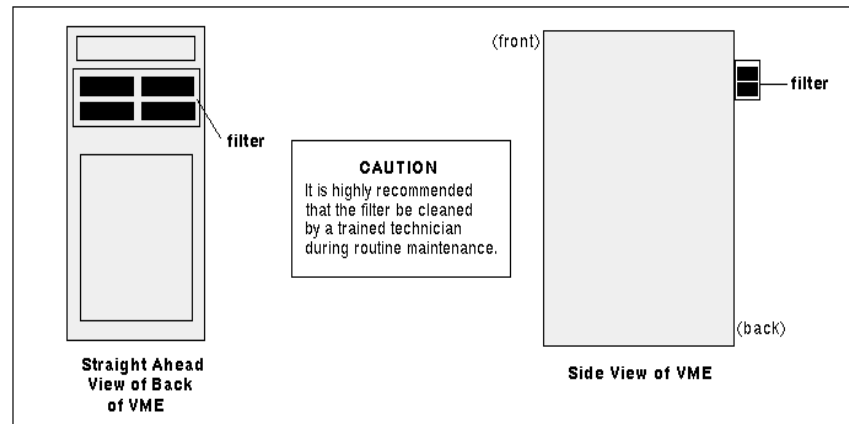

### Tape rotation

It is recommended that backup tapes be rotated daily. This requires that you have a minimum of two tapes. The backup tape should be rotated daily with an alternate tape to help reduce the chance of complete data loss due to tape failures.



#### Damage to tape drive

Do not unload the backup tape from the drive during a backup. Unloading the tape may cause damage to the tape drive.

### DAT head cleaning

It is recommended that the DAT heads be cleaned periodically using the DAT head cleaning tape. The cleaning tape is shipped with the system. To use, remove the DAT tape from the tape drive and insert the cleaning tape. Follow the instructions that accompany the cleaning tape.



#### Damage to tape drive

Do not unload the backup DAT from the DAT drive during a backup. Unloading the DAT tape may cause damage to the DAT drive.

The DAT drive is shown in the figure below.

Figure 4.2 DAT drive unit

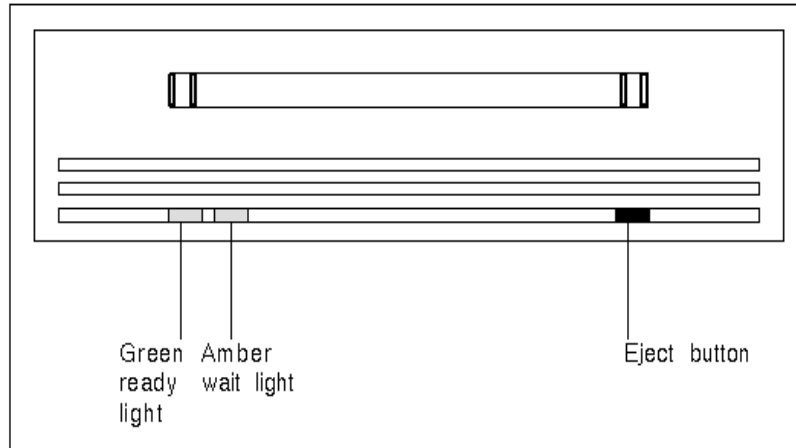



# *Appendices*

Technical  
Specifications

---

A

System Log  
Messages

---

B

Installing the  
SVR4 & AIX OS

---

C

Historical  
Database

---

D

System  
Configuration  
Reports

---

E





## Technical specifications

---

This appendix covers the following technical specifications for the CC MIS system:

- real-time performance
- reliability
- personal computer support
- power requirements
- environmental requirements

### Real-time performance

CC MIS is a message-driven system. Messages received from the DMS-ACD translate into many intertask messages that are used to drive the CC MIS Supervisor displays and other internal software. The real-time performance of the system depends largely on two factors, the message arrival rate (MAR) and the message service rate (MSR).

### Reliability

#### Consistent configuration data

ACD configuration data in the DMS-ACD and in the CC MIS system are kept consistent with one another. The DMS-ACD maintains a master copy of the configuration data. This data will be requested by the CC MIS whenever it initializes for any reason, such as recovery after the failure of the DATA LINK or the application software. If the DMS-ACD should initialize for any reason, then CC MIS will take down the application software and request that the configuration data be sent.

CC MIS has disk mirroring capability. Disk mirroring provides increased data protection and software/data availability. Disk Mirroring is provided by RAID hardware.



Disk mirroring is a purchasable option.

**Automatic backup**

To minimize the loss of historical data in the event of a disk failure, historical data files are backed up to tape every midnight. Each time the midnight routine runs, the new backup overwrites the previous one. For this reason, several backup tapes should be used and rotated daily.

**Power failure**

A 900 VA Uninterruptable Power Supply (UPS) provides approximately 20 minutes of backup battery power. If a power failure occurs, CC MIS runs on the UPS until power is restored. If power is not restored before the UPS fails, CC MIS automatically shuts down in an orderly manner. CC MIS interval data will not be collected during the period (if any) that CC MIS is shut down.

**Personal computer support**

CC MIS allows the use of any PC-AT compatible (that has at least the minimum required hardware configuration) for a supervisor display.



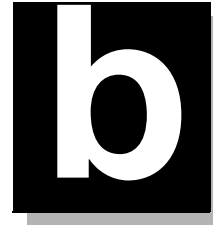

# System Log Messages

## STANDARD ERROR MESSAGES

### Introduction

This section contains a list of standard error messages generated by the CC MIS product. These messages may be generated by any of the subsystems of the CC MIS product and they can be either informational messages, warning messages, or fatal messages depending upon the conditions under which these errors are generated. The CC MIS product runs on a Down Stream Processor, hence the error messages will *NOT APPEAR IN THE SWITCH LOG*.

### Log Actions

The following are the possible actions which should be performed when a log message is generated. Each log message specification indicates one or more action codes. The actions should be performed in the order listed. If an action fails to resolve or determine the problem, the next listed action should be performed.

The actions are:

- A Possible installation problem. If the system was installed recently, re-install system. Otherwise, contact TAS - supply complete log messages.
- B Contact TAS - supply complete log messages.
- C Use database storage calculator to re-adjust database storage parameters. The storage calculator is accessed via the maintenance interface by selecting the configuration then data storage menu items. The following relationship exists for the tables.

if table is:	adjust parameters for:
i_agent	number of agents agent events per day
i_group, d_group, w_group, m_group	number of ACD groups
i_overflow, d_overflow, w_overflow, m_overflow	number of ACD groups source/dest interflow factor
i_agent, d_agent, w_agent, m_agent	number of agents position reassigns per day

if table is:	adjust parameters for:
i_lob, d_lob, w_lob, m_lob	number of ACD groups average LOBs/group
i_acddn, d_acddn, w_acddn, m_acddn	number of ACD groups number of Supplementary DNs DN reassigns per day
i_walk, d_walk, w_walk, m_walk	number of ACD groups average walk codes/group

Additionally, the hours of operation parameters may require adjustment.

- D Potential hardware or operating system failure. Contact hardware vendor with system error message and port name.
- E Contact design support prior to re-boot of system. Supply complete log messages.
- F Possible connectivity problem to switch. Verify all connections and communication equipment between CC MIS and switch. Verify X.25 port on VME. Contact vendor for X.25 problems.
- G Re-enable link in maintenance interface via “Diagnostics/X.25 diagnostics.”
- H Verify switch datafill parameters. If packet switch used, verify end-to-end X.25 parameters.
- I Check/verify switch datafill and status of MPC/EMPC.
- J No action required; normal operation of system. If problems are evident, check for other log messages.
- K Check/verify MIS session status on switch.
- L Potential problem only. Check other log messages carefully. If this log message occurs frequently, contact design support and supply all log messages.
- M Verify consistency of NOS logon parameters and switch datafill.
- N Verify that all CC MIS partitions are configured with a valid subpool name.
- O Verify that switch datafill parameters do not exceed CC MIS limits.
- P Verify switch datafill parameters do not exceed database storage calculator parameters.
- Q Verify switch datafill. Contact switch support.
- R May be caused by excessive switch or MIS activity. Monitor for other log messages.
- S Check/verify switch hardware components (IOC, MPC/EMPC).
- T Potential synchronization problem between switch and MIS. If switch datafill has been altered since last MIS re-initialization, then re-initialize MIS using the “Update Switch Configuration Data” command from the “Run State Utilities” maintenance menu.

- U Check/verify report parameters.
- V Verify system default printer has been defined. Check maintenance/configuration as well as Parameter Administration/Miscellaneous Options.
- W Consult the backup log.
- X Adjust report parameters.
- Y Check connectivity between CC MIS host and supervisor terminal.
- Z Check for compatibility of Windows interface software and CC MIS host software.
- AA Consult the restore log.
- AB Check CC MIS configuration.
- AC Re-initialize the X.25 card via the “X.25 Diagnostics” screen in the maintenance interface.
- AD Discontinue use of the “Call Park” feature.
- AE Verify that switch datafill uses only one login ID partition per subpool.
- AF The backup did not complete and may need to be restarted and monitored.
- AG The restore did not complete and the system may be in an unknown state. The restore may need to be restarted and closely monitored.
- AH Deselect translation of un-needed messages and retry.
- AI Check/Verify configuration.

### Standard Log Format

All log messages use the following format (note that portions within square brackets [ ] appear only when appropriate):

```
<message type> at <date> <time>  
<message text>  
Process: <process> (<pid>)[Partition:<partition>][Instance:<instance>]  
Source: <module>, <function>, <line>  
[<other info>]
```

Where:

<message type> = FATAL, WARNING, EVENT  
<date> = current date (MM/DD/YY)  
<time> = current time (HH:MM:SS)  
<message text> = see list below  
<process> = link\_read, display, hdc, etc.  
<pid> = Unix process ID of the process calling log function.  
<partition> = partition number in which the process is running.  
<instance> = indicates which instance of a process this is for processes which may have multiple invocations.  
<module> = module which generated the log message  
<function> = function which generated the log message  
<line> = line number within module at which error occurred  
<other info> = may include items such as an operating system code for operating system errors

The error message text may contain [XX] and/or 'YYYY' which denote any numeric and/or string, respectively.

## General Messages

The following messages may be generated by any process within CC MIS.

### Database read failure [xx] -- table: yyyy

An error occurred while reading data from the table specified in the “yyyy” field. “xx” gives the database error code. (Action Code: B)

### Database write failure [xx] -- table: yyyy

An error occurred while writing data to the table specified in the “yyyy” field. “xx” gives the database error code. (Action Code: B)

### Database deletion failure [xx] -- table: yyyy

An error occurred while trying to delete a record from the table specified in the “yyyy” field. “xx” gives the database error code. (Action Code: B)

### Database connect failure [xx]

An error occurred while trying to connect to the database server process in order to perform a database operation. “xx” gives the database error code. (Action Code: B)

### Database table lookup failure [xx] -- table: yyyy

An error occurred while trying to obtain database structure information for the table specified in the “yyyy” field. “xx” gives the database error code. (Action Code: B)

### Database record lookup failure [xx] -- rectype: yyyy

An error occurred while trying to obtain database structure information for the record type specified in the “yyyy” field. “xx” gives the database error code. (Action Code: B)

### Database record lookup failure [xx] -- table: yyyy

An error occurred while trying to obtain database structure information for the record type used in the database table specified in the “yyyy” field. “xx” gives the database error code. (Action Code: B)

### Database record count failure [xx] -- table: yyyy

An error occurred while trying to obtain the count of records in the database table specified in the “yyyy” field. “xx” gives the database error code. (Action Code: B)

### Database record enumeration failure [xx] -- table: yyyy

An error occurred while trying to enumerate the records in the database table specified in the “yyyy” field. “xx” gives the database error code. (Action Code: B)

### Database record parse failure [xx] -- table: yyyy

An error occurred while trying to parse a record in the database table specified in the “yyyy” field. “xx” gives the database error code. (Action Code: B)

### Connection to database server not established

An attempt was made to perform a database request when no connection to the database server had been established. (Action Code: B)

**Failed to send request to database server**

An error occurred when attempting to send a database request message to the database server.  
(Action Code: B)

**Failed to receive response from database server**

An error occurred when attempting to read a database response message from the database server.  
(Action Code: B)

**Unexpected message received from database server**

The program received a message from the database server that it did not expect. (Action Code: B)

**File mapping failure -- file: xxxxx**

Following a database enumeration request in which the resulting records were to be sorted, the program experienced an error attempting to map the results file named in the “xxxxx” field into its address space. (Action Code: B)

**File unmapping failure -- file: xxxxx**

Following a database enumeration request in which the resulting records were to be sorted, the program experienced an error attempting to unmap the results file named in the “xxxxx” field from its address space. (Action Code: B)

**Language record parse error -- type: xxxxx**

The program encountered a language record that it was unable to parse. The type of the record being parsed is named in the “xxxxx” field. (Action Code: B)

**Main record parse error -- type: xxxxx, field: nn**

The program encountered a main database record that it was unable to parse. The type of the record being parsed is named in the “xxxxx” field, and the field number which could not be parsed is given in the “nn” field. (Action Code: B)

**Poll failed**

The “poll” system call returned an error code. (Action Code: B)

**I/O port open error - port: yyyy**

Indicates that the program was unable to open the I/O port identified by “yyyy”. The “system error” description should provide additional information as to the reason for the error. (Action Code: D)

**I/O port setup error**

Indicates that the program was unable to properly set the communications parameters for its I/O port. The “system error” description should provide additional information as to the reason for the error. (Action Code: D)

**I/O port read error**

Indicates that the program was unable to read from its associated I/O port. The “system error” description should provide additional information as to the reason for the error. (Action Code: D)

**I/O port write error**

Indicates that the program was unable to write to its associated I/O port. The “system error” description should provide additional information as to the reason for the error. (Action Code: D)

**File open error - file: yyyy**

Indicates that the program was unable to open the file specified by “yyyy”. (Action Code: B)

**Freopen error - file: yyyy**

Indicates that the program was unable to reopen the file specified by “yyyy”. (Action Code: B)

**File create error - file: yyyy**

Indicates that the program was unable to create the file specified by “yyyy”. (Action Code: B)

**File write error - file: yyyy**

Indicates that the program was unable to write to the file specified by “yyyy”. (Action Code: B)

**Pipe creation error - pipe: yyyy**

Indicates that the program was unable to create the named pipe specified by “yyyy”. Named pipes are used for communicating between programs. (Action Code: B)

**Pipe open error - pipe: yyyy**

Indicates that the program was unable to open the named pipe specified by “yyyy”. Named pipes are used for communicating between programs. (Action Code: B)

**Pipe write error - pipe: yyyy**

The program was unable to write to the named pipe specified by “yyyy”. (Action Code: B)

**Pipe read error - pipe: yyyy**

The program was unable to read from the named pipe specified by “yyyy”. (Action Code: B)

**Memory allocation failure**

The program was unable to allocate any additional memory. (Action Code: B)

**Unable to create a new process**

The program was unable to create a new process. This could indicate that there are a large number of defunct or runaway processes in the system. A system reboot may alleviate the problem. (Action Code: E)

**Unable to start “yyyy” program**

The program was unable to start the specified program. The “system error” description should provide additional information as to the reason for the error. (Action Code: B)

**yyyy environment variable not found**

The specified environment variable was not found. This indicates that the program encountering the error is being run in the wrong environment. This is a design error which should only occur during software development. (Action Code: B)

**SIGHUP: Hang-up signal received**

The process received a hang-up signal. This log message should never occur. (Action Code: B)

**SIGINT: Interrupt signal received**

The process received an interrupt signal. This log message should never occur. (Action Code: B)

**SIGILL: Illegal instruction**

An illegal instruction was executed by the process. This log message should never occur. However, it could be associated with memory problems, potential disk failure, or installation errors. (Action Code: A, E)

**SIGFPE: Floating-point exception**

An invalid floating point operation occurred. (Action Code: B)

**SIGEMT: Unexpected signal**

A process received an unexpected emulation trap signal. (Action Code: B)

**SIGBUS: Bus error**

A bus error occurred. This is typically generated by an invalid memory pointer but may also be generated by faulty memory. (Action Code: B)

**SIGSYS: Bad argument to system call**

A system call was executed with invalid parameters. (Action Code: B)

**SIGPIPE: Write to pipe with no read process**

A write was issued to a IPC pipe but the reader process is no longer active. (Action Code: L)

**SIGQUIT: Unexpected signal**

A process received an unexpected signal to quit. (Action Code: L)

**SIGTERM: Process terminated**

This message is normally generated by processes as they are terminating. (Action Code: J)

**SIGSEGV: Segmentation violation**

This message may be generated due to an invalid memory pointer. It may also be generated due to hardware problems. (Action Code: B)

**SIGIOT: IOT trap**

An I/O trap was received on an input or output operation. (Action Code: B)

**SIGTRAP: Trace trap**

This message is generated if processes are being traced. This signal should never occur. (Action Code: B)

**Socket creation failed - type: AF\_UNIX/STREAM**

Indicates that the program was unable to create a new socket. The “other info” line may include additional information. (Action Code: B)



**Socket bind failed - socket: yyyy**

Indicates that the program was unable to bind the socket to the file specified by “yyyy”. (Action Code: B)

**Socket listen failed - socket: yyyy**

Indicates that the program was unable to set the socket up as a listen socket. The “yyyy” field specifies the name of the socket. (Action Code: B)

**Socket connect failed - socket: yyyy**

Indicates that the program was unable to connect to the listen socket specified by “yyyy”. (Action Code: B)

**Socket accept failed - socket: yyyy**

Indicates that the program was unable to accept a connection to the listen socket specified by “yyyy”. (Action Code: B)

**Lock error (nn) - lock: yyyy**

An error occurred (specified by the “nn” field) getting the lock specified by “yyyy”. (Action Code: B)

**File stat error - file: yyyy**

An error occurred retrieving file status information on the file specified by “yyyy”. (Action Code: B)

**Unexpected signal: nn**

An unexpected signal was received by the process. The signal value is specified by “nn”. (Action Code: B)

## MAPA Messages

### Introduction

This section contains the error messages generated by the MAPA subsystem of the CC MIS product. The CC MIS product runs on a Down Stream Processor, hence the error messages will not appear in the SWITCH LOG.

Some of the messages listed in this section relate to MAPA's networking capabilities and cannot be generated in this release of the product. These logs could be generated in future releases when these capabilities are used. These logs will be identified by the phrase **(future)** in the message text.

### Informational Messages

This section lists the informational messages that may be generated by the MAPA process. These messages are produced as part of normal system operation to indicate the occurrence of significant events.

**Clock has been synchronized to network time** (future)

MAPA has completed synchronizing the time on the local node with the network time. (Action Code: J)

**Node nnn (xxxxxx) is UP** (future)

The remote node whose ID and name are given by "nnn" and "xxxxxx" respectively is now operational. (Action Code: J)

**Starting network time synchronization...** (future)

MAPA is starting to synchronize the time on the local node with the network time. This log only appears during system start-up. (Action Code: J)

**System shutdown completed**

MAPA has completed the orderly shutdown of the system and is exiting without error. This occurs when the system is shut down. (Action Code: J)

**System startup initiated**

MAPA is starting the orderly startup of the system. (Action Code: J)

### Warning Messages

This section lists the warning messages that may be generated by the MAPA process. These messages usually indicate an unusual condition that can be appropriately handled by the MAPA process, and which does not prevent the MAPA process from continuing operation.

**Accept failed on connection socket - type: xxxxxx**

MAPA was unable to accept a connection request as part of the startup of a connection-oriented service. The "xxxxxx" field will indicate either AF\_UNIX or AF\_INET depending on whether the connection request was internal or external respectively. (Action Code: B)

**Accept failed on socket for “xxxxxx” port**

MAPA was unable to accept a connection request on the TCP port whose logical name is given by the “xxxxxx” field. Currently, these ports are used for establishing connections from LAN connected supervisor workstations but their use may be expanded in future releases. The name of the port gives an indication of the type of service that is provided by that port. MAPA will attempt to correct the problem by re-creating the socket for this port. (Action Code: L)

**Asked to add client xxxxxx to unknown partition “nnn”**

The system attempted to register the LAN-connected PC whose IP address is given by “xxxxxx” against the partition whose ID is given by “nnn”. (Action Code: B)

**Asked to add client xxxxxx to unknown port “xxxxxx”**

The system attempted to register the LAN-connected PC whose IP address is given by “xxxxxx” against an unknown TCP port named “xxxxxx”. (Action Code: B)

**Asked to add duplicate node ID “nnn” (future)**

A request was made to add a network node to the system using a node ID that is already in use. (Action Code: L)

**Asked to add duplicate node address “xxxxxx” (future)**

A request was made to add a network node to the system using a node address that is already in use. (Action Code: L)

**Asked to add service for unknown program “xxxxxx”**

MAPA was requested to begin monitoring a program whose name (given by “xxxxxx”) is unknown to MAPA. (Action Code: B)

**Asked to change maximum on lock in unknown partition “nnn”**

A request was received to change the maximum for a lock in a unknown partition. The unknown partition ID is given by “nnn” in the log message. (Action Code: B)

**Asked to change maximum on unknown lock “nnn:xxxxxx”**

A request was received to change the maximum for an unknown partition/lock combination. The “nnn:xxxxxx” field in the log message specifies the partition ID and lock name. (Action Code: B)

**Asked to delete all clients in unknown partition “nnn”**

A request was received to delete all IP address registrations against the partition whose ID is given by “nnn”. (Action Code: B)

**Asked to delete local node (future)**

A network node deletion request was received which specified the local node as the node to be deleted. (Action Code: B)

**Asked to delete unknown node ID “nnn” (future)**

A network node deletion request was received which specified an unknown node to be deleted. (Action Code: L)

**Asked to delete unknown partition “nnn”**

A partition deletion request was received for a unknown partition. (Action Code: L)

**Asked to disable networking for unknown partition “nnn” (future)**

A request was received to disable networking for an unknown partition. (Action Code: B)

**Asked to enable networking for unknown partition “nnn” (future)**

A request was received to enable networking for an unknown partition. (Action Code: B)

**Asked to lock “xxxxxx” in unknown partition “nnn”**

A lock request was received to lock the “xxxxxx” resource in an unknown partition whose ID is given by “nnn”. (Action Code: B)

**Asked to register xxxxxx “nnn” against unknown partition “ppp”**

A request was received to register an IPC object against an unknown partition. The IPC object being registered is identified by:

xxxxxx Specifies the type of IPC object, where SHMID identifies a shared memory segment, SEMID identifies a semaphore, and MSGID identifies a message queue.

nnn Specifies the ID number of the IPC object.

(Action Code: B)

**Asked to run “xxxxxx” in inactive partition “nnn”**

A request was received to run program “xxxxxx” in a partition which is currently in the stopped state. (Action Code: L)

**Asked to run “xxxxxx” in unknown partition “nnn”**

A request was received to run program “xxxxxx” in a partition which is unknown. (Action Code: L)

**Asked to run “xxxxxx” on unknown node “nnn”**

A request was received to run program “xxxxxx” on a node which is unknown. (Action Code: L)

**Asked to set environment for unknown partition “nnn”**

A request was received to set an environment variable in a unknown partition. (Action Code: B)

**Asked to set process limit for unknown class “xxxxxx”**

A request was received to change the process limit for an unknown transient program class. (Action Code: L)

**Asked to set process limit for unknown partition “nnn”**

A request was received to change a transient process limit for an unknown partition. (Action Code: L)

**Asked to start unknown partition “nnn”**

A request was received to start an unknown partition. (Action Code: L)

**Asked to start unknown program “xxxxxx”**

A request was received to start an unknown program. The name of the program is identified by “xxxxxx”.  
(Action Code: L)

**Asked to stop unknown partition “nnn”**

A request was received to stop an unknown partition. (Action Code: L)

**Asked to unlock “xxxxxx” in unknown partition “nnn”**

A request was received to unlock the resource identified by “xxxxxx” in an unknown partition. (Action Code: L)

**Clock synchronization failed****(future)**

MAPA was unable to set the local system clock to the average network time. (Action Code: B)

**Connection timeout expired**

A timeout occurred while creating the connection for a connection-oriented service. (Action Code: B)

**Dependent program “nnn” not found for program “xxxxxx”**

The program description for the program named “xxxxxx” specifies that it is dependent on an unknown program whose program number is given by “nnn”. (Action Code: B)

**Environment space exhausted for partition “nnn”**

There is no more space available for storing private environment variables for the partition whose number is “nnn”. (Action Code: B)

**Error reading service ID from connection socket - bytes=n**

A request for a connection-oriented service has failed because the complete service ID (4 bytes long) could not be read from the connection socket. MAPA was able to read only “n” bytes of the service ID. (Action Code: B)

**Failed to kill program xxxxxx (nnn)**

MAPA was unable to kill the program whose name is “xxxxxx” and process ID is “nnn”.  
(Action Code: L)

**Failed to set RT priority - pid: ppp, priority: nnn**

MAPA was unable to set a real-time priority for the process whose process ID is given by “ppp”. The requested real-time priority value was “nnn”. (Action Code: B)

**Failed to set TS priority - pid: nnn, priority: nnn**

MAPA was unable to set a time-sharing priority for the process whose process ID is given by “ppp”. The requested time-sharing priority value was “nnn”. (Action Code: B)

**Halt request received - shutdown starting**

A halt request was received. MAPA is proceeding with graceful system shutdown. (Action Code: J)

**Lock “nnn:xxxxxx” is unknown**

A lock request was received for an unknown lock. “nnn:xxxxxx” is the partition number and name of the unknown lock. (Action Code: B)

**MAPA message queue found in IPC registry**

Indicates that MAPA found its own message queue identifier in the list of message queues to be deleted upon program or partition termination. MAPA automatically removes this object from the list. (Action Code: L)

**MAPA shared memory found in IPC registry**

Indicates that MAPA found its own shared memory segment identifier in the list of shared memory segments to be deleted upon program or partition termination. MAPA automatically removes this object from the list. (Action Code: L)

**Network response timeout - message type: xxxxxx (future)**

No response was received within the allotted timeout period for a message sent to a remote node. The type of message is "xxxxxx". (Action Code: B)

**No network time available - using nodal time (future)**

Indicates that MAPA was unable to find any other nodes on the network during system startup and is therefore using the current time of the system instead of setting the system time to the average time of all other nodes on the network. (Action Code: J)

**No object type in IPC register request from process nnn**

The type of Inter-Process Communication (IPC) object was not specified in an IPC object registration request. "nnn" is the process ID of the program which sent the request. (Action Code: B)

**Nodal time adjustment failed (future)**

MAPA was unable to make an adjustment to the nodal time in order to bring it in line with the network time. (Action Code: B)

**Node nnn (xxxxxx) not responding (future)**

A node in the network is not responding to messages sent to it. "nnn" is the node ID number and "xxxxxx" is the node name. (Action Code: L)

**Node table is full (future)**

No more node table slots are available for a new node. (Action Code: B)

**Partition "nnn" already exists**

A request was received to create a partition which already exists. (Action Code: L)

**Program "nnn (xxxxxx)" asked to kill unknown service "[nnn.]PPP.ppppp"**

MAPA received a request to kill a program that it does not know about. The program is identified by a 2 or 3 part identifier as follows:

- nnn Specifies the node ID on which the program is running. This part of the identifier will not appear if the program is on the local node.
- PPP Identifies the partition ID in which the program is running.
- ppppp Identifies the Unix process ID of the program.

(Action Code: B)

**Program “nnn (xxxxxx)” attempted to register MAPA message queue**

The identified program asked MAPA to register MAPA’s own message queue for deletion upon program or partition termination. “xxxxxx” and “nnn” is the name and process ID of the program making the request. (Action Code: L)

**Program “nnn (xxxxxx)” attempted to register MAPA shared memory**

The identified program asked MAPA to register MAPA’s own shared memory segment for deletion upon program or partition termination. “xxxxxx” and “nnn” is the name and process ID of the program making the request. (Action Code: L)

**Partition table is full**

No more partition table slots are available for a new partition. (Action Code: B)

**Partition type “xxxxxx” not found**

A request was received to create a partition of a type that is not known. “xxxxxx” is the invalid partition type. (Action Code: B)

**Program xxxxxx (nnn) aborted: ddddddddddddddd**

The program specified has aborted abnormally. “xxxxxx” and “nnn” is the name and process ID of the aborted program, and “dddddddddddddd” is the description of the abort cause. (Action Code: B)

**Program xxxxxx (nnn) is dead**

The program specified has died. xxxxxx= program name, (nnn)= programs process ID. (Action Code: B)

**Program xxxxxx (nnn) is insane**

The program specified was declared insane and will be killed by MAPA. xxxxxx= program name, (nnn)= programs process ID. (Action Code: B)

**Program table is full**

No more program table slots are available for a new program instance. (Action Code: B)

**Received “xxxxxx” from unrecognized program “nnn (pppppp)”**

The message xxxxxx was received from an unrecognized program with process ID of (nnn) and program name of (pppppp). (Action Code: L)

**Remote program xxxxxx (nnn.PPP.ppppp) is insane (future)**

A program started on a remote node in the network has been declared insane and will be killed by MAPA. “xxxxxx” is the name of the program and “nnn.PPP.ppppp” is the program’s service ID as follows:

- nnn Specifies the node ID on which the program is running.
- PPP Identifies the partition ID in which the program is running.
- ppppp Identifies the Unix process ID of the program.

(Action Code: B)

**Service addition request from unknown program “nnn”**

A request was received to register an already running process with MAPA but the process sending the request is unknown to MAPA. (Action Code: B)

**Socket receive failed (future)**

MAPA was unable to receive a message from a remote node. (Action Code: B)

**Socket send failed (future)**

MAPA was unable to send a message to a remote node. (Action Code: B)

**Unable to bind address for xxxxxx stream socket**

MAPA was unable to bind an address to the stream socket whose type is given by “xxxxxx”. The “xxxxxx” field will indicate either AF\_UNIX or AF\_INET depending on whether the socket is for internal or external communication respectively. (Action Code: B)

**Unable to bind address for message socket (future)**

MAPA was unable to bind an address to the message socket used to communicate with other nodes in the network. (Action Code: B)

**Unable to create xxxxxx stream socket**

MAPA was unable to create a stream socket whose type is given by “xxxxxx”. The “xxxxxx” field will indicate either AF\_UNIX or AF\_INET depending on whether the socket is for internal or external communication respectively. (Action Code: B)

**Unable to create listen queue for stream socket**

The queue used to listen for requests on a stream socket could not be created. (Action Code: B)

**Unable to create message socket (future)**

MAPA was unable to create the message socket used to communicate with other nodes in the network. (Action Code: B)

**Unable to determine ID of priority class “xx”**

MAPA was unable to determine the numeric ID of the priority class given by “xx”. “xx” will be either “TS” for the time-sharing priority class, or “RT” for the real-time priority class. (Action Code: B)

**Unable to set system time**

A failure occurred trying to set a new system time. (Action Code: B)

**Unauthorized connection attempt on port “xxxxxx” from nnn.nnn.nnn.nnn**

A connection attempt was received on the TCP port whose name is given by “xxxxxx” from an IP address which is not authorized to connect to this system. The IP address of the unauthorized user is given by “nnn.nnn.nnn.nnn”. (Action Code: AB)

**Unexpected acknowledgment for message type nnn, txid=xxx (future)**

An acknowledgment message was received which was not expected. The type and transaction ID of the message being acknowledged is given by the “nnn” and “xxx” fields respectively. (Action Code: B)



**Unknown message type “xxx” received from “nnn”**

Mapa received a message which it is not able to parse. (Action Code: B)

**Unknown service ID “xxxxxx” in SRVC\_BEGUN message (future)**

A remote node has indicated that it has started a service on behalf of the local node that the local node is not aware of. (Action Code: B)

**Unknown service ID “xxxxxx” in connection request**

A request for a connection-oriented service has failed because the service ID read from the connection socket could not be found in the program table. (Action Code: B)

*Fatal Error Messages*

Fatal error messages are generated by MAPA in response to conditions which prevent the process from continuing normal execution. This section lists these error messages.

**Directory “xxxxxx” does not exist**

A change directory command failed to find the specified directory. (Action Code: B)

**Entry nnn in LOCKS section has invalid lock type**

The file which describes the software configuration of the system contains an invalid instruction. Specifically, an invalid lock type was specified for item number “nnn” in the LOCKS section of the file. (Action Code: B)

**Entry nnn in LOCKS section is invalid**

The file which describes the software configuration of the system contains an invalid instruction. Specifically, item number “nnn” in the LOCKS section of the file could not be parsed. (Action Code: B)

**Entry nnn in PARTITIONS section is invalid**

The file which describes the software configuration of the system contains an invalid instruction. Specifically, item number “nnn” in the PARTITIONS section of the file could not be parsed. (Action Code: B)

**Entry nnn in PORTS section is invalid**

The file which describes the software configuration of the system contains an invalid instruction. Specifically, item number “nnn” in the PORTS section of the file could not be parsed. (Action Code: B)

**Entry nnn in PROGRAMS section has invalid class**

The file which describes the software configuration of the system contains an invalid instruction. Specifically, an invalid program class was specified in item number “nnn” in the PROGRAMS section of the file. (Action Code: B)

**Entry nnn in PROGRAMS section has invalid transient program class**

The file which describes the software configuration of the system contains an invalid instruction. Specifically, an invalid transient program class was specified in item number “nnn” in the PROGRAMS section of the file. (Action Code: B)

**Entry nnn in PROGRAMS section is invalid**

The file which describes the software configuration of the system contains an invalid instruction. Specifically, item number “nnn” in the PROGRAMS section of the file could not be parsed. (Action Code: B)

**Entry nnn in XPROG\_CLASSES section is invalid**

The file which describes the software configuration of the system contains an invalid instruction. Specifically, item number “nnn” in the XPROG\_CLASSES section of the file could not be parsed. (Action Code: B)

**Failed to re-create connection socket - type: xxxxxx**

The attempt to recreate a connection socket in an attempt to recover from an earlier “Socket accept failure” has failed. (Action Code: B)

**Invalid tag “xxxxxx” in GENERAL section of config file**

The file which describes the software configuration of the system contains an invalid instruction. Specifically, an invalid parameter name was found in the GENERAL section of the file. (Action Code: B)

**Invalid section name “xxxxxx” in configuration file**

The file which describes the software configuration of the system contains an invalid instruction. Specifically, an invalid section was found in the file. (Action Code: B)

**Lock table is full**

The lock table has become full. No more locks could be created. (Action Code; B)

**Message receive failed - queue ID: nnn**

Message queue read failed for some reason other than no messages in queue. “nnn” is the message queue identifier of the MAPA message queue. (Action Code: B)

**Message send failed - queue ID: nnn, msgtype: ttt, pid: ppp**

Message queue send failed for some reason other than message queue was full. The message queue identifier on which the send was attempted is given by “nnn”. The type of message being sent was “ttt” and the process to which it was being sent was “ppp”. (Action Code: B)

**Missing -c <configuration file> argument**

MAPA was invoked without the -c argument which tells it the file name of its configuration file. (Action Code: B)

**Missing section in configuration file**

The file which describes the software configuration of the system is missing a required section. (Action Code: B)

**No partitions defined**

No partitions were defined in the software configuration file. (Action Code: B)

**No programs defined**

No programs were defined in the software configuration file. (Action Code: B)

**Partition table is full**

Too many partition types were specified in the software configuration file. (Action Code; B)

**Port table is full**

Too many TCP ports were specified in the software configuration file. (Action Code; B)

**Program table is full**

Too many programs were specified in the software configuration file. (Action Code; B)

**Record nnn in physical node table is invalid****(future)**

Record number “nnn” in the physical node table which describes the nodes in the network could not be parsed. (Action Code: B)

**Transient program class table is full**

The file which describes the software configuration of the system contains an invalid instruction. Specifically, too many transient program classes were defined. (Action Code: B)

**Unknown program “xxxxxx” associated with TCP port pppppp**

The file which describes the software configuration of the system contains an invalid instruction. Specifically, the program used to service a request on the TCP port named “pppppp” was not described in the PROGRAMS section of the configuration file. (Action Code: B)

## DMSLINK Messages

### Introduction

This section contains the error message generated by the DMSLINK subsystem of the CC MIS product. The CC MIS product runs on a Down Stream Processor, hence the error messages will *NOT APPEAR IN THE SWITCH LOG*.

### Informational Messages

The following messages do not indicate an error condition but are used as notification of significant events which occur as part of normal operation.

#### Call data transfer beginning...

The switch has acknowledged the request to begin transferring call event data. (Action Code: J)

#### Connect confirmation on <x25 port>

The switch has acknowledged the connection request and established the connection. The “xxxxxx” field identifies the board and port over which the connection to the switch was made. (Action Code: J)

#### Disconnect confirmation on <x25 port>

The X.25 card has returned a confirmation of a disconnect issued by the near end. (Action Code: J)

#### End of initialization data download...

The switch has completed the initialization data download. (Action Code: J)

#### Initialization data download beginning...

The switch has responded to the request to send initialization data and is about to start the initialization data download. (Action Code: J)

#### Initiating a nosLogon...

DMSLINK is sending a nosLogon request to the switch. (Action Code: J)

#### Initiating a nosLogout...

DMSLINK is sending a nosLogout request to the switch. (Action Code: J)

#### LINK TRACING IS NOW OFF

Link messages in both directions are now being logged to the link data trace file. (Action Code: J)

#### LINK TRACING IS NOW ON

Link message tracing has been turned off and the trace file has been closed. (Action Code: J)

#### Network connection request #nnn on <x25 port>

The near end is attempting to make a data connection with the switch on the X.25 port identified by <x25 port>. This log is generated every 100 connection attempts or whenever a change in a connection failure reason is detected. The “nnn” field indicates the number of the connection attempt since the system was started or since the connection was last established. (Action Code: J)

**Network disconnect request on <x25 port>**

A near end disconnect request was made to the X.25 card and port identified by <x25 port>.  
(Action Code: J)

**Requesting initialization...**

DMSLINK is requesting initialization data from the switch. (Action Code: J)

**Requesting start of call data transfer...**

DMSLINK is requesting the switch to begin sending call event data. (Action Code: J)

**Reset confirmation on <x25 port>**

The X.25 card has returned a confirmation of a reset issued by the near end. (Action Code: J)

**Warning Messages**

This section lists the warning messages that may be generated by the DMSLINK process. These messages usually indicate an unusual condition that can be appropriately handled by the DMSLINK process, and which does not prevent the DMSLINK process from continuing execution.

**<ro type> is not a valid operation at this time**

A Remote Operation (RO) of type <ro type> was received from the switch at a time that was not appropriate (e.g. an initialization data RO was received when no dspRequestInit request has been issued). (Action Code: F, K, B)

**ACD group <primary dn> associated with unknown subpool number nn**

A switchSendAcdGroupData message was received from the switch that referenced a subpool for which CC MIS has not received a switchSendSubPoolData message for. (Action Code: F, R)

**ACD group configuration overflow error**

The merging of newly received initialization data with configuration information obtained from a previous initialization sequence has resulted in too many ACD groups in the configuration. This indicates a software problem in the CC MIS system. (Action Code: B)

**ACD-DN configuration overflow error**

The merging of newly received initialization data with configuration information obtained from a previous initialization sequence has resulted in too many ACD-DNs in the configuration. This indicates a software problem in the CC MIS system. (Action Code: B)

**Accept failed**

A request to accept a new application connection to this DMSLINK process has failed.  
(Action Code: B)

**Already Logged on - Logging off**

In attempting to logon to the switch, it was discovered that the switch believes the DSP is already logged on. The DSP will now request a logoff and restart the logon sequence. (Action Code: L)

**Application resource shortage error - type: nnn**

The switch is reporting an application resource shortage error of a type that is not recognized by the DSP. 'nn' gives the unrecognized reason code contained in the error message. No action is taken by DMSLINK other than reporting the error. (Action Code: Q)

**Associate request received for unknown subpool "<subpool name>"**

DMSLINK received a request from another process to associate itself with a subpool that is not in the configuration information received from the switch. (Action Code: N)

**Bad value in RO: rrrrrr, field: fffff, value: vvvvv**

An illegal value has been detected in an RO received from the switch. "rrrrr" identifies the type of RO, "fffff" gives the field within the RO, and "vvvvv" gives the illegal value. DMSLINK will attempt to continue regardless of the error. (Action Code: S, B)

**Connect confirmation on unknown circuit (ignored)**

A connect confirmation was received on an unknown circuit. The confirmation message is ignored. (Action Code: H)

**Connect request received (ignored)**

Received from the X.25 card a connect request. The connect request is ignored. (Action Code: H)

**Data receive local failure on <x25 port>**

The X.25 card returned an error on the X.25 port identified by <x25 port> following an attempt to receive data from the port. (Action Code: AC, F, B)

**Data received on unknown circuit (circuit closed)**

Data was received on a circuit not currently in use. The data is ignored and a disconnect is issued to the circuit reference. (Action Code: H)

**Disconnect confirmation on unknown or closed circuit (ignored)**

A disconnect confirmation was received on an unknown circuit. The confirmation message is ignored. (Action Code: H)

**Disconnect indication on unknown circuit (ignored)**

A network disconnect was received with an invalid circuit reference number. The disconnect is ignored. (Action Code: H)

**Disconnect indication received on <x25 port>; cause=<cause>; code=<code>**

The X.25 card has experienced a network disconnect on the X.25 port identified by <x25 port>. The clearing cause is <cause> and the diagnostic code is <code>. (Action Code: F, I, S)

**Dump in progress - LM request denied**

This error indicates that a DMS image is currently being taken and all load management requests will be rejected. This error condition is passed back to the CCLINK process in the response to its request. (Action Code: J)

**Error message received for unknown invoke ID nnn**

DMSLINK received a ReturnError message from the switch for an Invoke message that DMSLINK does not believe to be outstanding to the switch. (Action Code: L)

**Hard limit of nnn ACD groups reached**

Indicates that more than “nnn” unique ACD groups exist in the ACD pool to which the CC MIS has been associated. All further ACD groups will be silently discarded. The ACD group limit is determined from the options configured on the software load tape. (Action Code: O)

**Hard limit of nnnn ACD-DNs reached**

Indicates that more than “nnnn” unique ACD-DNs exist in the ACD pool to which the CC MIS has been associated. All further ACD-DNs will be silently discarded. The ACD-DN limit is determined from the options configured on the software load tape (17 x number of ACD groups configured). (Action Code: O)

**Hard limit of nnnn positions reached**

Indicates that more than “nnnn” unique position IDs exist in the ACD pool to which the CC MIS has been associated. All further position IDs will be silently discarded. The position limit is determined from the options configured on the software load tape. (Action Code: O)

**Hard limit of nnnn subgroups reached**

Indicates that more than “nnnn” unique subgroups exist in the ACD pool to which the CC MIS has been associated. All further subgroups will be silently discarded. The subgroup limit is determined from the options configured on the software load tape (number of positions configured / 2). (Action Code: O)

**Hard limit of nnn subpools reached**

Indicates that more than “nnn” unique subpools exist in the ACD pool to which the CC MIS has been associated. All further subpools will be silently discarded. The subgroup limit is currently set to 128. (Action Code: O)

**Illegal message type xx received on OOB pipe**

DMSLINK received an unrecognized message on the out-of-band events pipe from the simulator. The illegal message type is given by the 'xx' field in the error message. This message is simply ignored. (Action Code: L)

**Illegal message type [nn] received from application**

An illegal message type was received by DMSLINK from another CC MIS application. The message will be ignored. (Action Code: B)

**Interrupt data confirmation on <x25 port>**

Received confirmation from the X.25 card on interrupt type data sent. This type data transfer is not supported.  
(Action Code: H)

**Interrupt data indication on <x25 port>**

Interrupt data was received from the X.25 card. This type data transfer is not supported.  
(Action Code: H)

**Invalid argument error - type: nn**

The switch is reporting an invalid argument error of a type that is not recognized by the DSP. 'nn' gives the unrecognized reason code contained in the error message. No action is taken by DMSLINK other than reporting the error. (Action Code: L)

**Invalid arguments passed - ignored**

The DMSLINK process has been invoked with invalid arguments. The invalid arguments have been ignored. (Action Code: B)

**Invalid NOP protocol version**

The switch has rejected a logon request because the NOP protocol version requested by the DSP is invalid. (Action Code: I)

**Invalid line in initialization file**

At least one invalid line was found in the initialization file. (Action Code: B)

**Invalid subpool password - LM request denied**

A load management request has been denied because the subpool password as read from the configuration database does not match the password datafilled on the switch for the specified subpool. This error condition is passed back to the CCLINK process in the response to its request. (Action Code: M)

**LINK TRACE FILE SIZE LIMIT REACHED**

The link trace data file for this link has reached its maximum file size. Link data tracing has been terminated. (Action Code: J)

**Link <x25 port> disabled with active circuit**

The X.25 port identified by <x25 port> was disabled via the "X.25 Diagnostics" screen in the maintenance interface while an active connection to the switch was present. The switch connection was dropped. (Action Code: G)

**Lost connection to switch**

DMSLINK has lost communication with the switch. (Action Code: L, F)

**Lost synchronization on input data stream**

DMSLINK has lost synchronization on the input data stream and will attempt to resynchronize. (Action Code: L)

**Network bind request local failure on <x25 port>**

The X.25 card returned an error on the X.25 port identified by <x25 port> following an attempt to bind to the port. (Action Code: AC, F, B)

**Network connect request local failure on <x25 port>**

The X.25 driver returned an error when attempting to establish a connection on the X.25 port identified by <x25 port>. (Action Code: F)

**Network disconnect request local failure on <x25 port>**

The X.25 card returned an error on the X.25 port identified by <x25 port> following a near end disconnect request. (Action Code: F)



**No Remote Load Management process**

The switch could not create the Remote Load Management process in order to service a load management request from the DSP. This error condition is passed back to the CCLINK process in the response to its request. (Action Code: Q)

**No buffers available**

The switch has run out of buffer space for ACD-MIS ROs. No action is taken by DMSLINK other than reporting the error. (Action Code: Q)

**Non-control message received on unassociated socket**

An application program has sent a non-control message on a socket connection to DMSLINK before it has associated itself with a particular subpool. (Action Code: B)

**Operation sequence error - type: nn**

The switch is reporting an operation sequence error of a type that is not recognized by the DSP. 'nn' gives the unrecognized reason code contained in the error message. No action is taken by DMSLINK other than reporting the error. (Action Code: L)

**Pool already associated - Logging off**

The pool with which the DSP is attempting to associate itself is already associated with another DSP. DMSLINK will initiate a logoff sequence before terminating itself. (Action Code: M, Q)

**Position nnnn unexpectedly moved to another ACD group**

An event message was received for position "nnnn" which indicates that it is now in an ACD group which is different from the ACD group that the CC MIS system believes it to be in. This could be caused by lost messages on the X.25 link. (Action Code: F)

**Position configuration overflow error**

The merging of newly received initialization data with configuration information obtained from a previous initialization sequence has resulted in too many positions in the configuration. This indicates a software problem in the CC MIS system. (Action Code: B)

**Posn nnnn moved with call active: sssssssss -> dddddddddd**

The CC MIS system has determined that position "nnnn" was moved via load management with an ACD call active. The ACD group in which the call was answered is given by "ssssssss" and the new ACD group is given by "ddddddddd". Call timings will be split between the two ACD groups with all call time after the time of the error message being logged against the new ACD group. (Action Code: J)

**Posn nnnn moved with call presented: sssssssss -> dddddddddd**

The CC MIS system has determined that position "nnnn" was moved via load management with an ACD call presented to the agent. The ACD group in which the call was originally received is given by "ssssssss" and the new ACD group is given by "ddddddddd". All statistics for this call will be logged against the new ACD group. (Action Code: J)

**RO rejected by DSP - type: tttttt, code: cccccc**

A badly formatted RO was received by the DSP and has been rejected. The "ttttt" field identifies the type problem encountered (General, Invoke, ReturnResult, or ReturnError) and the "ccccc" field provides the specific

problem code. The hexadecimal dump of the received message will follow in the error log. (Action Code: M, B, Q)

**RO rejected by switch - type: tttttt, code: cccccc**

The switch rejected an RO sent by DMSLINK. The “ttttt” field identifies the type problem encountered (General, Invoke, ReturnResult, or ReturnError) and the “ccccc” field provides the specific problem code. (Action Code: M, B)

**Reject message received for unknown invoke ID nnn**

DMSLINK received a Reject message from the switch for an Invoke message that DMSLINK does not believe to be outstanding to the switch. (Action Code: L)

**Reset confirmation on unknown circuit (ignored)**

The X.25 card has returned a confirmation of a reset issued by the near end but on a circuit that DMSLINK does not know about. (Action Code: L)

**Reset indication received on <x25 port> (cause=<cause>; code=<code>)**

Received a network reset request on circuit reference <ref>. The clearing cause is <cause> and the diagnostic code is <code>. (Action Code: I)

**Reset indication received on unknown circuit (ignored)**

A reset packet was received on a circuit not currently in use. The reset is ignored. (Action Code: L)

**Response timeout on <ro type> request - retrying...**

DMSLINK has not received a response from the switch for the message whose type is given by <ro type>. DMSLINK will retry the request up to three times before giving up and re-establishing the link. (Action Code: L)

**Result message received for unknown invoke ID nnn**

DMSLINK received a return result for an invoke message numbered “nnn” which does not appear to have been generated by CC MIS. (Action Code: Q)

**Searching for a link...**

Connection attempts have failed on all links to the switch. DMSLINK continues to attempt to establish a connection. (Action Code: F, I, S)

**Simulator process has died**

The simulator process for this link has died. DMSLINK will automatically restart it. (Action Code: B)

**Subgroup configuration overflow error**

The merging of newly received initialization data with configuration information obtained from a previous initialization sequence has resulted in too many subgroups in the configuration. This indicates a software problem in the CC MIS system. (Action Code: B)

**Subpool nnn is using the “Call Park” feature**

DMSLINK has determined that the “Call Park” feature is being used in subpool number “nnn”. Use of this feature is not supported by CC MIS and will cause invalid statistics to be gathered. (Action Code: AD)

**Subpool nnn uses multiple (mmm) login ID partitions**

DMSLINK has determined that the multiple login ID partitions are being used in subpool number “nnn”. This will cause statistics for the same agent IDs in different login ID partitions to be accumulated under the same agent ID in the CC MIS historical database. (Action Code: AD)

**Subpool configuration overflow error**

The merging of newly received initialization data with configuration information obtained from a previous initialization sequence has resulted in too many subpools in the configuration. This indicates a software problem in the CC MIS system. (Action Code: B)

**Switch is running a different NOP protocol version (xxxxx)**

The switch is running a protocol version than is that being used by DMSLINK. Some messages may fail when DMSLINK attempts to decode them. (Action Code: M)

**Switch not responding...terminating session**

Indicates that a message has been retransmitted to the switch the maximum number of times without receiving a response. DMSLINK is now terminating the existing session with the switch and will attempt to re-establish it. (Action Code: F)

**Switching to backup link <x25 port>...**

The data connection to the switch was terminated and the CC MIS is now attempting a new connection with the specified link. (Action Code: F, I, S)

**Synchronization regained after skipping nnn bytes**

DMSLINK has regained synchronization on the input data stream from the switch after skipping over “nnn” bytes of data. Some data has been lost. (Action Code: F)

**System problem error - type: nn**

The switch is reporting a system problem error of a type that is not recognized by the DSP. 'nn' gives the unrecognized reason code contained in the error message. No action is taken by DMSLINK other than reporting the error. (Action Code: Q)

**There is no X.25 link enabled**

The configuration database shows all physical links are disabled for the logical link being managed by this instance of the DMSLINK process. (Action Code: G)

**Time changed backwards**

The system clock has been changed backwards. Historical data accumulated around the time of this error log should not be trusted. (Action Code: B)

**Too many ROs outstanding from DSP**

The switch has indicated that it currently has too many unprocessed Remote Operations outstanding to be able to process the one just sent by the DMSLINK process. This error would indicate a problem with the switch since DMSLINK does not allow more outstanding ROs to be sent to the switch than can be handled by the switch according to the ACD-MIS protocol specification. No action is taken by DMSLINK other than reporting the error. (Action Code: Q)

**Undefined X.25 event <nnn> received (ignored)**

The X.25 driver indicated an event occurred that is not defined. The “nnn” field gives the event type number. (Action Code: B)

**Updating physical link configuration**

DMSLINK has been notified of a potential change in the status of its X.25 port. This log appears when the “X.25 Diagnostics” screen is used to disable or enable an X.25 link. (Action Code: J)

**Value range error in non-LM request**

The switch is reporting a value range error in a request that is not a load management request. No action is taken by DMSLINK other than reporting this error. For LM request messages encountering a value range error, this error condition is passed back to the CCLINK process for appropriate handling. (Action Code: L)

**X.25 bind request failed - reason: <reason description>**

DMSLINK was unable to bind itself to the X.25 port used to communicate with the switch. (Action Code: AC)

*Fatal Error Messages*

Fatal error messages are generated by DMSLINK in response to conditions which prevent the process from continuing normal execution. This section lists these error messages.

**ACD pool protocol “xxxxx” is not supported**

The ACD pool protocol datafiled on the switch for this link is invalid. (Action Code: Q)

**Data transmit local failure on <x25 port>**

The X.25 driver returned an error while attempting to transmit data to the switch via the X.25 port identified by <x25 port>. (Action Code: F, B)

**Invalid parameter [c] in initialization file**

An invalid parameter was found in the initialization file. The invalid parameter is identified by “[c]” in the error message. (Action Code: B)

**Invalid pool password**

The password for the pool as read from the system database does not match the password datafiled on the switch for the pool. (Action Code: M)

**Invalid pool protocol**

The switch is not running the correct protocol version. (Action Code: M)

**Local failure to open X.25 driver <name>**

The attempt to open the X.25 device driver failed. The device driver’s full pathname is given by <name>. (Action Code: B)

**Maximum logons exceeded**

The switch has disallowed the DSP's request to logon because it already has the maximum number of simultaneous logons in progress. (Action Code: K, S)

**Missing parameter in initialization file**

At least one parameter is missing from the initialization file specified by the “-f” option used to invoke the DMSLINK process. (Action Code: B)

**Unable to open startup file: xxxxxx**

DMSLINK was unable to open the startup configuration file specified by the “-f” option used to invoke the DMSLINK process. (Action Code: B)

**Unable to set STREAMS read options on X.25 device**

The attempt to set up the proper read options on the X.25 driver failed. (Action Code: B)

**Unable to start ACDMIS application on switch**

The switch is returning an invalid argument error stating that it does not recognize the application ID. (Action Code: Q)

**Unable to start simulator process**

DMSLINK was unable to start the simulator process for a simulated link. (Action Code: B)

**Undefined pool name**

The pool name as read from the system database does not match any ACD pool datafiled on the switch. (Action Code: M)

**User ID or password is invalid**

The user ID or password as read from the system database does not agree with any user ID/password combination programmed on the switch. The request for the start-up of the ACD-MIS application has been denied. (Action Code: M)

**Wrong switch state for request**

The switch is indicating that it is in the wrong state to accept a request from the DSP. To re-synchronize the switch and the DSP, DMSLINK will initiate a logoff/logon sequence followed by a re-initialization. (Action Code: Q)

## *CCLINK Messages*

### *Introduction*

This section lists the error/warning messages that may be generated by CCLINK. These messages usually indicate an unusual condition that has occurred within CC MIS software.

### *Warning Error Messages*

This section lists the warning messages that may be generated by the CCLINK process. These messages usually indicate an unusual condition that can be appropriately handled by the CCLINK process, and which does not prevent the CCLINK process from continuing execution.

#### **Invalid CC message received**

CCLINK received an unknown message. (Action Code: B)

#### **Configuration Control transaction log is corrupted.**

The Configuration Control transaction log has become corrupted. (Action Code: B)

#### **Switch connection aborted**

The switch aborted its connection. (Action Code: B)

#### **Switch connection has aborted; retrying...**

The switch has aborted its connection, CCLink is attempting to reconnect. (Action Code: B)

#### **Unable to send LM command to switch**

The switch did not accept the load management command. (Action Code: B)

### *Fatal Error Messages*

Fatal error messages are generated by CCLINK in response to conditions which prevent the process from continuing normal execution. This section lists these error messages.

#### **Subpool yyyy on link nnnn does not exist**

The subpool yyyy does not exist on link nnnn. (Action Code: H)

## *RPTGEN Messages*

### *Introduction*

This section contains the error message generated by the RPTGEN subsystem of the CC MIS product. The CC MIS product runs on a Down Stream Processor, hence the error messages will *NOT APPEAR IN THE SWITCH LOG*.

### *Warning Messages*

This section lists the warning messages that may be generated by the RPTGEN process. These messages usually indicate an unusual condition that can be appropriately handled by the RPTGEN process, and which does not prevent the RPTGEN process from continuing execution.

#### **Unable to print: rptgen tabular output.**

A failure was received from the call to print\_job. (Action Code: L)

#### **Unable to print: rptgen eventlog output.**

A failure was returned by the call to print\_job. (Action Code: L)

#### **grgen is deferring sanity a second time.**

This message is generated when the system is extremely busy and grgen needs to defer sanity a second time. (Action Code: R)

#### **Unable to lock DATA database.**

RPTGEN was unable to obtain a lock on the data database. (Action Code: L)

#### **Unable to unlock DATA database.**

RPTGEN was unable to release the lock on the data database. (Action Code: L)

The following errors are all warning messages dealing with file close and file unlink errors. These errors occur when the system calls fclose and unlink return bad return codes. (Action Code: B)

#### **Unable to close file: stdout.**

#### **Unable to unlink graphic report intermediate file.**

#### **Unable to close file: graphic preview file.**

#### **Unable to close graphic report intermediate file.**

### *Fatal Error Messages*

Fatal error messages are generated by RPTGEN in response to conditions which prevent the process from continuing normal execution. This section lists these error messages.

#### **Invalid arguments used to invoke rptgen.**

#### **Invalid arguments used to invoke grgen.**

The above two messages are generated if an invalid argument is found when parsing the argument line which is passed in to start these processes. (Action Code: B)

**Unable to read file: graphic report intermediate file.**

A system call to fgets returned a bad return code. (Action Code: B)

**Invalid report number requested**

A report was requested that doesn't exist. (Action Code: U)

**Unable to find delimiter character**

Display was unable to find the delimiter character, and is therefore unable to print the report. (Action Code: B)

Following is a list of GRAFSMAN related FATAL errors. The return codes are defined in the GRAFSMAN documentation. (Action Code: B)

**Unable to start SWS graphic processor, rc = xxxx**

This message is displayed if an error occurs when calling ggbegin. (Action Code: B)

**Unable to open SWS graphic template, rc = xxxx**

This message is displayed if an error occurs when calling ggopen. (Action Code: B)

**Unable to set axis label and scaling, rc = xxxx**

This message is displayed if an error occurs when calling ggaxis. (Action Code: B)

**Unable to replace legend strings, rc = xxxx**

This message is displayed if an error occurs when calling gglegend. (Action Code: B)

**Unable to replace text strings, rc = xxxx**

This message is displayed if an error occurs when calling ggtext. (Action Code: B)

**Unable to associate a device with SWS proc., rc = xxxx**

This message is displayed if an error occurs when calling ggdevice. (Action Code: B)

**Unable to send data to SWS proc., rc = xxxx**

This message is displayed if an error occurs when calling ggdata. (Action Code: B)

**Unable to draw graph with SWS proc., rc = xxxx**

This message is displayed if an error occurs when calling ggdraw. (Action Code: B)

**Unable to terminate SWS proc., rc = xxxx**

This message is displayed if an error occurs when calling ggend. (Action Code: B)



## CFGDB Messages

### Introduction

This document contains the error messages generated by the CFGDB subsystem of the CC MIS product. The CC MIS product runs on a Down Stream Processor, hence the error messages *NOT APPEAR IN THE SWITCH LOG*.

### Warning Messages

This section lists the warning messages that may be generated by the CFGDB process. These messages usually indicate an unusual condition that can be appropriately handled by the CFGDB process, and which does not prevent the CFGDB process from continuing execution. Although not fatal, many of these warnings indicate a serious condition which may require attention.

#### Unable to lock configuration database

An error occurred trying to lock the configuration database. (Action Code: B)

#### Unable to obtain CONFDB read lock

An error occurred trying to obtain a read lock on the configuration database. (Action Code: B)

#### Unable to obtain CONFDB write lock

An error occurred trying to obtain a write lock on the configuration database. (Action Code: B)

#### Unable to unlock configuration database

An error occurred trying to unlock the configuration database. (Action Code: B)

### Fatal Error Messages

Fatal error messages are generated by CFGDB in response to conditions which prevent the process from continuing normal execution. This section lists these error messages.

#### Options file read error

An error occurred trying to read the global options file. (Action Code: B)

#### Unable to determine my customer ID number

An error occurred trying to determine the partition ID from the environment. (Action Code: B)

#### Error parsing record in yyyy.

An error occurred trying to parse a record in the specified file. (Action Code: B)

#### File seek error - file: yyyy

An error occurred trying to seek to a location in the specified file. (Action Code: B)

#### File stat failure - file: yyyy

An error occurred trying to stat the specified file. (Action Code: B)

**File tell error - file: yyyy**

An error occurred trying to perform an ftell on the specified file. (Action Code: B)

## CFGMGR Messages

### Introduction

This document contains the error messages generated by the CFGMGR subsystem of the CC MIS product. The CC MIS product runs on a Down Stream Processor, hence the error messages *NOT APPEAR IN THE SWITCH LOG*.

### Warning Messages

This section lists the warning messages that may be generated by the CFGMGR process. These messages usually indicate an unusual condition that can be appropriately handled by the CFGMGR process, and which does not prevent the CFGMGR process from continuing execution. Although not fatal, many of these warnings indicate a serious condition which may require attention.

#### **Could not flush message buffer**

An error occurred trying to flush the message buffer. (Action Code: B)

#### **Could not make socket non-blocking**

An error occurred trying to make a socket non-blocking. (Action Code: B)

#### **Could not write message to cfgmgr**

An error occurred trying to write a message to the cfgmgr. (Action Code: B)

#### **COMPORTS table access failure (rc = xxxx)**

An error occurred trying to access the COMPORTS database table. (Action Code: B)

#### **CUST\_INFO table access failed for custID xxxx (rc = xxxx)**

An error occurred trying to access the CUST\_INFO database table. (Action Code: B)

#### **CUST\_INFO table access failed for partition xxxx**

An error occurred trying to access the CUST\_INFO database table. (Action Code: B)

#### **CUST\_INFO table access failure (rc = xxxx)**

An error occurred trying to access the CUST\_INFO database table. (Action Code: B)

#### **CUST\_INFO update fails for partition xxxx after move (rc = xxxx)**

An error occurred trying to access the COMPORTS database table. (Action Code: B)

#### **Cannot use link number xxxx (max is xxxx)**

The specified link number is greater than the maximum number of links allowed. (Action Code: B)

#### **Could not add partition xxxx**

An error occurred trying to add the specified partition. (Action Code: B)

#### **Could not allocate disk xxxx for partition xxxx.**

An error occurred trying to add the specified disk for the specified partition. (Action Code: B)

**Could not calculate free space on disk xxxx**

An error occurred trying to calculate the free space on the specified disk. (Action Code: B)

**Could not determine move completion status for partition xxxx**

An error occurred trying to determine the move completion status for the specified partition. (Action Code: B)

**Could not reset reinit time for link xxxx**

An error occurred trying to reset the reinitialization time for the specified partition. (Action Code: B)

**Could not restart partition xxxx after the move**

An error occurred trying to restart the specified partition after it was moved. (Action Code: B)

**Could not transition partition xxxx to correct mode.**

An error occurred trying to transition the specified partition to the correct mode. (Action Code: B)

**Failed to remove data database for partition xxxx**

An error occurred trying to remove the data database for the specified partition. (Action Code: B)

**Failed to send move acknowledgment to PID xxxx**

An error occurred trying to send the move acknowledgment to the specified process ID. (Action Code: B)

**Failed to set up system database for partition xxxx**

An error occurred trying to set up the system database for the specified partition. (Action Code: B)

**Insufficient space on disk to change partition size to xxxx megs**

An error occurred trying to set up the system database for the specified partition. (Action Code: B)

**Insufficient space to add partition xxxx to diskNum xxxx**

There is insufficient space to add the specified partition to the specified disk. (Action Code: B)

**Invalid message type (xxxx)**

An invalid message was received. (Action Code: B)

**LANCONNECTS table access failure (rc = xxxx)**

Unable to access record in the LANCONNECTS table. (Action Code: B)

**LINK\_DEF Table access failure (rc = xxxx)**

Unable to access record in the LINK\_DEF table. (Action Code: B)

**No further move processing will be performed for partition xxxx**

No further move processing will occur for the specified partition due to an error trying to determine the move completion status. (Action Code: B)

**Port xxxx not found in PortTbl**

The specified port was not found in the port table. (Action Code: B)

**Service execution for “age -c” fails (rc = xxxx)**

An error occurred trying to execute “age -c”. (Action Code: B)

**cfgmgr socket interface not initialized**

The cfgmgr socket interface is not initialized. (Action Code: B)

**client\_add fails for partition xxxx, IP yyyy, mistext (rc = xxxx)**

An error occurred trying to add a text based LAN client. (Action Code: B)

**client\_add fails for partition xxxx, IP yyyy, miswindows (rc = xxxx)**

An error occurred trying to add a windows based LAN client. (Action Code: B)

**client\_delete fails for IP yyyy, mistext (rc = xxxx)**

An error occurred trying to delete a text based LAN client. (Action Code: B)

**client\_delete fails for IP yyyy, miswindows (rc = xxxx)**

An error occurred trying to delete a windows based LAN client. (Action Code: B)

**could not de-register yyyy shared memory segment with MAPA (rc = xxxx)**

An error occurred trying to de-register a shared memory segment with MAPA. (Action Code: B)

**could not register yyyy shared memory segment with MAPA (rc = xxxx)**

An error occurred trying to register a shared memory segment with MAPA. (Action Code: B)

**could no restart partition xxxx after mode change**

An error occurred trying to restart the specified partition after a mode change. (Action Code: B)

**could not stop partition xxxx to change modes**

An error occurred trying to stop the specified partition so that a mode change could be performed. (Action Code: B)

**partition xxxx must be assigned a disk to change modes**

The partition must be assigned a disk before changing modem. (Action Code: AI)

**partition ID xxxx out of range [1..xxxx]**

The specified partition ID is out of range. (Action Code: B)

**partition\_delete fails for partition xxxx (rc = xxxx)**

An error occurred trying to delete the specified partition. (Action Code: B)

**received delete message for unknown partition “xxxx”**

A delete message was received for an unknown partition. (Action Code: B)

**request\_service fails for program yyyy (rc = xxxx)**

A request\_service failed for the specified program. (Action Code: B)

**CUST\_INFO access failure (partition=xxxx; rc=xxxx)**

Unable to access record in the CUST\_INFO table. (Action Code: B)

**Cannot start partition xxxx in SETUP mode**

Cannot start a partition in SETUP mode. (Action Code: AI)

**DBSTORAGE table access failure (rc = xxxx)**

Unable to access record in the DBSTORAGE table. (Action Code: B)

**DBSTORAGE table not initialized for partition xxxx**

The DBSTORAGE table is not initialized for the specified partition. (Action Code: B)

**LINK\_DEF table access failure (linkNum=xxxx; rc=xxxx)**

Unable to access record in the LINK\_DEF table. (Action Code: B)

**Link number xxxx not found**

The specified link number was not found. (Action Code: B)

**Live type link required to start partition xxxx in product mode**

You must have a live link to start a partition in product mode. (Action Code: AI)

**No more partitions using a live link may be started (max = xxxx)**

The maximum number of live partitions has already been reached. (Action Code: AI)

**No subpool name defined for partition xxxx**

There is no subpool name defined for the specified partition. (Action Code: AI)

**No subpool password defined for partition xxxx**

There is no subpool password defined for the specified partition. (Action Code: AI)

**STOREPARMS table access failure (custID = xxxx, rc = xxxx)**

Unable to access record in the STOREPARMS table. (Action Code: B)

**Simulator type link required to start partition xxxx in training mode**

You must have a simulator link to start a partition in training mode. (Action Code: AI)

**invalid partition mode (partition=xxxx; mode=xxxx)**

The partition has an invalid mode. (Action Code: B)

**no disk selected for partition xxxx**

There is no disk selected for the specified partition. (Action Code: B)

**no link selected for partition xxxx**

There is no link selected for the specified partition. (Action Code: B)

**partition number xxx out of range**

The partition number is out of range. (Action Code: B)

**Could not flush message buffer**

An error occurred trying to flush the message buffer. (Action Code: B)

**Could not make socket non-blocking**

An error occurred trying to make the socket non-blocking. (Action Code: B)

**Unrecognized message xxxx received from xxxx**

An unrecognized message is received. (Action Code: B)

**cfgmgr closing socket to cfgutil (cfgutil PID = xxxx)**

An error occurred closing the socket to the cfgutil process. (Action Code: B)

**completion acknowledgment fails (type = xxxx, sequence = xxxx)**

An error occurred trying to send a completion acknowledgment. (Action Code: B)

**lost connection with client**

The connection was lost with the client. (Action Code: B)

**message acknowledgment fails (type = xxxx, sequence = xxxx)**

An error occurred trying to send a message acknowledgment. (Action Code: B)

**socket read error**

A socket read error occurred. (Action Code: B)

**COMPORTS table access failure**

Unable to access record in the COMPORTS table. (Action Code: B)

**CUST\_INFO table access failure (custID = xxxx; rc = xxxx)**

Unable to access record in the CUST\_INFO table. (Action Code: B)

**Could not create ager signal file “yyyy”**

An error occurred trying to create the ager signal file. (Action Code: B)

**DBSTORAGE table access failure**

Unable to access record in the DBSTORAGE table. (Action Code: B)

**DISKS table access failure (diskNum = xxxx; rc = xxxx)**

Unable to access record in the DISKS table. (Action Code: B)

**Error xxxx deleting from DBSTORAGE table**

The specified error occurred trying to delete a record from the DBSTORAGE table. (Action Code: B)

**Error xxxx deleting record yyyy from LANCONNECTS table**

The specified error occurred trying to delete a record from the LANCONNECTS table. (Action Code: B)

**Error xxxx deleting record (key xxxx) from CUST\_INFO table**

The specified error occurred trying to delete a record from the CUST\_INFO table. (Action Code: B)

**Error xxxx deleting record (key xxxx) from CUST\_OPTIONS table**

The specified error occurred trying to delete a record from the CUST\_OPTIONS table. (Action Code: B)

**Error xxxx deleting record (key xxxx) from STOREPARMS table**

The specified error occurred trying to delete a record from the STOREPARMS table. (Action Code: B)

**Error xxxx deleting record (key xxxx) from WALLBOARDS table**

The specified error occurred trying to delete a record from the WALLBOARDS table. (Action Code: B)

**LANCONNECTS table access failure**

Unable to access record in the LANCONNECTS table. (Action Code: B)

**PRINTERS table access failure**

Unable to access record in the PRINTERS table. (Action Code: B)

**WALLBOARDS table access failure**

Unable to access record in the WALLBOARDS table. (Action Code: B)

**COMPORTS table access failure (rc = xxxx)**

Unable to access record in the COMPORTS table. (Action Code: B)

**CUST\_INFO table access failure (custID = xxxx; rc = xxxx)**

Unable to access record in the CUST\_INFO table. (Action Code: B)

**CUST\_OPTIONS table access failure (custID = xxxx; rc = xxxx)**

Unable to access record in the CUST\_OPTIONS table. (Action Code: B)

**Cannot initialize partition xxxx**

Unable to initialize the specified partition. (Action Code: B)

**Creation of partition xxxx fails (rc = xxxx)**

Unable to create the specified partition. (Action Code: B)

**DISKS table access failure (diskNum = xxxx; rc = xxxx)**

Unable to access record in the DISKS table. (Action Code: B)

**Failed to set partition limit for partition xxxx (rc = xxxx)**

An error occurred trying to set the limits for the specified partition. (Action Code: B)



**LANCONNECTS table access failure (rc = xxxx)**

Unable to access record in the LANCONNECTS table. (Action Code: B)

**LINK\_DEF table access failure (rc = xxxx)**

Unable to access record in the LINK\_DEF table. (Action Code: B)

**client\_add fails (yyyy, xxxx, mistext)**

Unable to add a text based LAN client. (Action Code: B)

**client\_add fails (yyyy, xxxx, miswindows)**

Unable to add a windows based LAN client. (Action Code: B)

**get\_partition\_state fails for partition xxxx**

Unable to determine the state of the specified partition. (Action Code: B)

**Error occurred communicating with MAPA**

Unable to report initialization to MAPA. (Action Code: B)

**STDTbl entry not found**

Unable to find the service ID entry in the service ID table. (Action Code: B)

**Cannot start partition xxxx**

Error trying to start the specified partition. (Action code: B)

**Configuration problem for partition xxxx**

There is a configuration problem with the specified partition. (Action Code: B)

**Failed to retrieve CUST\_INFO record for partition xxxx (rc = xxxx)**

Error trying to retrieve a record from the CUST\_INFO table for the specified partition. (Action Code: B)

**Failed to retrieve LINK\_DEF record (xxxx) for partition xxxx (rc = xxxx)**

Error trying to retrieve a record from the LINK\_DEF table for the specified partition. (Action Code: B)

**Unable to start partition xxxx**

Error trying to start the specified partition. (Action Code: B)

**Unable to stop partition xxxx**

Error trying to stop the specified partition. (Action Code: B)

**request\_service fails for “yyyy” (rc = xxxx)**

Request service failed for the specified service. (Action Code: B)

**SID table size consistency error**

There is an inconsistency in the size of the service ID table. (Action Code: B)

**lan clients table size consistency error**

There is an inconsistency in the size of the lan clients table. (Action Code: B)

**link table size consistency error**

There is an inconsistency in the size of the link table. (Action Code: B)

**Caught SIGCHLD from death of unknown process (PID = xxxx)**

The SIGCHLD signal was received from the death of an unknown process. (Action Code: B)

**Could not create ager signal file “yyyy”**

Error trying to create the ager signal file. (Action Code: B)

**Could not make directory “yyyy”**

Error trying to create the specified directory. (Action Code: B)

**More than xxxx wallboards defined on port xxxx**

There are more than the specified number of wallboards defined on the port. (Action Code: B)

**Re-initialization response error occurred for link xxxx**

A re-initialization response error occurred for the specified link. (Action Code: B)

**SIGTERM: process terminated**

The SIGTERM signal was received. (Action Code: J)

**Unable to connect to link xxxx**

Error trying to connect to the specified link. (Action Code: B)

**cfgdb: error xxxx reading yyyy table**

An error occurred trying to read the specified table. (Action Code: B)

**non-implemented error message class (xxxx)**

An unrecognized error return value was received. (Action Code: B)

**Unknown hard ID (xxxx) received on wallboard commands pipe**

An unknown wallboard hard ID was received. (Action Code: B)

*Informational Messages*

The following messages do not actually indicate an error condition but are used as notification of significant events which occur as part of normal operation.

**caught SIGUSR1: updating internal state tables**

Received the SIGUSR1 signal after a backup occurred indicating that the internal state tables will be updated.

**caught SIGUSR2: reinitialization static language shared memory**

CFGMR received a signal to reload the static language shared memory segment. (Action Code: L)

**Move of partition xxxx beginning**

The move of the specified partition has started. (Action Code: J)

**Move of partition xxxx failed**

The move of the specified partition has failed. (Action Code: B)

**Move of partition xxxx successful**

The move of the specified partition was successful. (Action Code: J)

*Fatal Error Messages*

Fatal error messages are generated by CFGMR in response to conditions which prevent the process from continuing normal execution. This section lists these error messages.

**Unable to communicate with MAPA**

Error trying to communicate with MAPA while trying to (re)start programs. (Action Code: B)

## DISPLAY Messages

### Introduction

This section contains the error messages generated by the DISPLAY subsystem of the CC MIS product. DISPLAY writes the messages to their 'Standard Error' device. The error messages may contain [XX] and/or 'YYYY' which denote any numeric and/or string, respectively.

### Informational Messages

This section lists the log messages that may be generated by the DISPLAY process(es). These messages provide useful information to the user.

#### **yyyy has logged in.**

This message is logged whenever a supervisor logs in to the CC MIS system. The yyyy is replaced by the supervisor name. (Action Code: J)

#### **yyyy has logged out.**

This message is logged whenever a supervisor logs out of the CC MIS system. The yyyy is replaced by the supervisor name. (Action Code: J)

### Warning Messages

This section lists the warning messages that may be generated by the DISPLAY process(es). These messages usually indicate an unusual condition that can be appropriately handled by the process(es), and which do not prevent the process from continuing execution.

#### **No element records associated with quadrant**

Indicates that the real-time display subsystem could not find the data element specifications for a quadrant definition. The real-time display screen will not be entered in this case. (Action Code: B)

#### **Printer type 'xxxx' is not supported**

Areal-time display snapshot report has been requested for a printer which has an invalid GRAFCAP device type associated with it. The invalid device type is specified in the "xxxx" field. The requested report will not be generated. (Action Code: B)

#### **Error reading graphic page file name**

In graphic report preview, at most 500 bytes will be displayed on the VDT at a time. To continue displaying the graphic report, a new graphic page file name must be extracted from an appropriate file. This warning indicates that the graphic page file name does not exist in the file. (Action Code: B)

#### **Fewer pages than expected in graphic preview file**

Indicates that the number of pages in the graphic report file is less than the number of pages in the graphic preview request. (Action Code: B)

#### **Invalid file type found in preview file**

Indicates that the preview information file contains neither a tabular nor graphic report format. (Action Code: B)

**Invalid file type found in CC log file**

Indicates that the configuration control file does not contain the preview tabular file type. (Action Code: B)

**File link error: SRC=yyyy, DST=yyyy**

Indicates that an error had occurred when making a temporary file which is a link to the configuration control log text file in the same directory as the log. (Action Code: B)

**lang\_statfind fails**

Indicates that an error had occurred when finding the field name in the language database. (Action Code: B)

**unknown calculation component**

Indicates that an element of the calculation expression is neither a valid operand nor operator. (Action Code: B)

**Error computing the number of elements in list defn**

A database routing failed while attempting to determine the number of elements in a list. (Action Code: B)

**Error sending file to the printer**

An error occurred trying to print the current list. (Action Code: V)

**Format error in print job status file: yyyy**

The print job status file contains a format error. (Action Code: B)

**Format error on line xxxx in print job file: yyyy**

The print job file contains an error on line xxxx. (Action Code: B)

**Print job file not found: yyyy****Print job status inconsistency found****Unable to send command to modem**

Display was unable to send a command to the modem. (Action Code: AI)

**Error reading configuration database**

Display was unable to read the configuration database. (Action Code: B)

*Fatal Error Messages*

Fatal error messages are generated by DISPLAY in response to conditions which prevent the process from continuing normal execution. This section lists these error messages.

**Invalid arguments passed**

Invalid parameters were specified on the command line that was used to start the display task. (Action Code: B)

**Invalid baud rate**

An invalid baud rate was specified on the command line. (Action Code: B)

**No list menu has been built**

Indicates that a list name was searched for when there was no valid list (`cur_list_type = 0`). (Action Code: B)

## USRIF Messages

### Introduction

This section contains the error messages generated by the USRIF subsystem of the CC MIS product. USRIF writes the messages to its 'Standard Error' device. The error messages may contain [XX] and/or 'YYYY' which denote any numeric and/or string, respectively.

### Warning Messages

This section lists the warning messages that may be generated by the USRIF subsystem. These messages usually indicate an unusual condition that can be appropriately handled by the process, and which do not prevent the process from continuing execution.

#### **Too many help screens. Help will appear out of sync with current screen.**

Help screens have nested too deeply (beyond MAX\_STACK\_TAGS-1). When this occurs, the additional levels are ignored. The visible effect of this is help text that doesn't match the screen where help is being sought. (Action Code: B)

#### **No '=' found in keyboard description entry**

Entry in <term>.KD file is improperly formatted. (Action Code: B)

#### **No terminating '\' found for keyboard label**

A key translation specification in the <term>.KD file contains only the name of the key. (Action Code: B)

#### **Keystroke sequence missing**

The sequence of characters sent from the keyboard for this key is missing from the <term>.KD file. (Action Code: B)

#### **Logical function key definition is missing**

The key translation sequence for a required key is missing. (Action Code: B)

#### **Periodic function list is full**

An attempt to add another function to the list of functions periodically activated while awaiting keyboard input has failed because the list is full. (Action Code: B)

#### **Invalid window number**

A request was made to redraw a non-existent window. (Action Code: B)

#### **Window does not correspond to a menu**

Request made to redraw a window that is not a menu. (Action Code: B)

#### **Failed to determine spool pipe status**

Was unable to determine status of the pipe serving the print spooler. (Action Code: B)

**Bad ACDTERMCAP parameter: missing '#' for numeric parameter.**

The specification for a numeric parameter in the ACDTERMCAP file is missing a required '#'. (Action Code: B)

**Bad ACDTERMCAP parameter: string parameter lacks '='.**

The specification for a string parameter in the ACDTERMCAP file is missing a required '='. (Action Code: B)

**Bad ACDTERMCAP parameter: Illegal escape character.**

Only a character from the set EeNlRtbfS^\\,;01234567 can be escaped via the backslash. (Action Code: B)

**No '=' found in video attribute entry**

The entry in the <term>.VA file is improperly formatted. (Action Code: B)

**Invalid attribute name in video attribute file**

Unknown attribute name specified in <term>.VA file. (Action Code: B)

**Duplicate video attribute**

Video specification has already been defined in <term>.VA file. (Action Code: B)

**Logical video attribute definition is missing**

One of the video attributes was not defined for the selected terminal type. (Action Code: B)

**No '=' found in special character entry**

The entry in the <term>.SC file is improperly formatted. (Action Code: B)

**Logical character code is invalid**

The internal character code is not within the range of 1-254. (Action Code: B)

**Physical character code is invalid**

The external character code is not within the range of 1-254. (Action Code: B)

**Unable to open special character file**

Either the <term>.SC file couldn't be located or its access rights prohibited read access. (Action Code: B)

**Table form has not yet been created**

Attempt to animate a table form that has not been created. (Action Code: B)

**Invalid character following '^'**

In <term>.VA file, character being control-shifted is not in the set of @, A-Z, a-z, [, \, ], ^, or \_ . (Action Code: B)

**Invalid token**

Token being converted is not an octal number. (Action Code: B)

**Value of token exceeds 377 octal**

The token's value as specified in the <term>.VA file exceeds 377 octal (Action Code: B)



**Missing definition for video attribute**

A definition for a video attribute is missing. (Action Code: AI)

**Invalid monochrome attribute specification**

An invalid monochrome attribute was specified. (Action Code: AI)

**Missing foreground color specification**

A foreground color specification is missing. (Action Code: AI)

**Missing background color specification**

A background color specification is missing. (Action Code: AI)

**Invalid foreground color specification**

An invalid foreground color was specified. (Action Code: AI)

**Invalid background color specification**

An invalid background color was specified. (Action Code: AI)

*Fatal Error Messages*

Fatal error messages are generated by USRIF in response to conditions which prevent the process from continuing normal execution. This section lists these error messages.

**cannot acquire memory from system**

There exists an insufficient amount of system memory to create the key handling information tables. (Action Code: B)

**Invalid logical key name in keyboard file**

In initializing key translation specifications in the <term>.KD file, an unknown key name has been encountered. (Action Code: B)

**Pathname of keyboard description file is unknown**

No kF entry, usually in the form of kF=<term>.KD, was specified in the product termcap file. (Action Code: B)

**Unable to open keyboard description file**

Either the <term>.KD file could not be found or read access was not allowed. (Action Code: B)

**Error reading keyboard description file**

Though the <term>.KD file was found and read access was available, an error occurred while reading the file. (Action Code: B)

**Unable to create error message virtual screen**

Attempt to create the one-line error dialog window on the bottom of the screen was unsuccessful. (Action Code: B)

**Keyboard description file is empty**

The <term>.KD file contained no properly formatted key translation specifications. (Action Code: B)

**Menu does not contain any menu items**

Request was made to create a menu that has no items defined. (Action Code: B)

**Unable to open ACD-MIS termcap file.**

The file defined by environment variable ACDTERMCAP could not be found or its access rights prohibited reading it. (Action Code: B)

**Pathname of video attributes file is unknown**

The aF entry in the ACDTERMCAP file was not specified. (Action Code: B)

**Unable to open video attributes file**

The aF entry in the ACDTERMCAP file was given incorrectly such that the video attributes file can not be found (Action Code: B)

**Error reading video attributes file**

Though the <term>.VA file could be found and had read access rights available, an error occurred in reading the file. (Action Code: B)

**Error reading special characters file**

Though the <term>.SC file was located and allowed read access, an error occurred during reading it. (Action Code: B)

**Could not set terminal into raw mode**

Attempt to reset standard input parameters failed. (Action Code: B)

**Non-contiguous CELL array**

This error indicates that the DSP's memory allocation for c types char and byte are not equal. (Action Code: B)

**Too many virtual screens**

The number of defined virtual screens has reached its maximum number. (Action Code: B)

**Too many windows**

The number of defined windows has reached its maximum number. (Action Code: B)

**Number of windows is inconsistent**

The window counter indicates that at least one window slot should be available, but the window number array is full. (Action Code: B)

**No entry found in ACDTERMCAP file for yyyy**

The specified term setting is not valid, or is not supported. (Action Code: AI)

**Memory allocation failure**

The process was unable to allocate enough memory. (Action Code: B)

## *STSMGR Messages*

### *Introduction*

This section contains the error messages generated by the STSMGR subsystem of the CC MIS product.

The error messages may contain [XX] and/or 'YYYY' which denote any numeric and/or string, respectively.

### *Warning Messages*

This section lists the warning messages that may be generated by the STSMGR process. These messages usually indicate an unusual condition that can be appropriately handled by the process, and which do not prevent the process from continuing execution.

#### **Maximum number of ACD groups (nnn) exceeded**

Initialization data has been received for more than the maximum number of ACD groups. “nnn” specifies the current maximum. (Action Code: O)

#### **Maximum number of positions (nnn) exceeded**

Initialization data has been received for more than the maximum number of agent positions. “nnn” specifies the current maximum. (Action Code: O)

#### **Maximum number of supervisors (nnn) exceeded**

Initialization data has been received for more than the maximum number of supervisor positions. “nnn” specifies the current maximum. (Action Code: O)

#### **Can't get Database Lock**

STSMGR Manager was unable to acquire the database lock. (Action Code: L)

#### **Database is full. No further records are being saved.**

The database has reached its maximum size, and will no longer save data. (Action Code: C)

#### **Database open error: “yyyy” : yyyy**

The STSMGR process was unable to open the ACDDN statistics interval file. File name “yyyy” with database error yyyy. (Action Code: B)

#### **Errors dumping to “yyyy” : xxxx OK, XXXX BAD**

When dumping yyyy, STSMGR was able to write xxxx records, and was unable to write XXXX records. (Action Code: B)

#### **Request for AGE -c failed**

STSMGR was unable to call age -c. (Action Code: B)

#### **Request for aging failed**

The request for database aging failed. (Action Code: B)

**Unable to lock data database for writing**

STSMGR was unable to establish a lock on the data database to enable writing. (Action Code: B)

**Unable to unlock data database**

STSMGR was unable to unlock the data database

**VFG xxxx is used in xxxx ACD groups**

The VFG entry xxxx is used in more than one ACD groups. (Action Code: B)

**Connection to link has been terminated**

The DMSLINK process that STSMGR was connected to died. (Action Code: L)

**Invalid command line argument - ignored**

An invalid command line argument was specified. (Action Code: B)

**Request for aging failed**

The STSMGR request for aging failed. (Action Code: B)

**\*\*\*Call duration less than zero**

The call duration time was less than zero. (Action Code:)

**Error [xxxx] moving agent [xxxx] into assigned APR subgroup [xxxx]**

An error occurred while trying to move an agent into their assigned APR subgroup. (Action Code:I)

**Error [xxxx] returning position [xxxx] to prior subgroup [xxxx]**

An error occurred trying to return position xxxx to its prior subgroup xxxx. (Action Code:)

**Error [xxxx] sending request assign agent [xxxx] to assigned APR subgroup [xxxx]**

An error occurred while attempting to request a move agent. (Action Code:)

**Error [xxxx] sending request to return position [xxxx] to prior subgroup [xxxx]**

An error occurred

**Sample duration [xxxx seconds] exceeds sample interval****Error reading partition options**

An error occurred while trying to read the partition options. (Action Code: B)

**ACD stat duration less than zero**

The ACD stat duration is less than zero. (Action Code:)

**DN Call duration less than zero**

A DN call duration was less than zero. (Action Code: R)

**\*\*\*Invalid APR subgroup [xxxx] configured for agent [xxxx]**

An invalid APR subgroup is configured for agent xxxx. (Action Code:

*Fatal Error Messages*

Fatal error messages are generated by STSMGR in response to conditions which prevent the process from continuing normal execution. This section lists these error messages.

**Can't get database storage limit**

STSMGR was unable to determine the database storage limit. (Action Code: B)

**Subpool yyyy on link xxxx does not exist**

The subpool yyyy on link xxxx does not exist. (Action Code:

**STOREPARMS table access failed (rc = xxxx)**

STSMGR encountered an error while trying to access the storage parameters. (Action Code: B)

*Informational Messages*

The following messages do not actually indicate an error condition but are used as notification of significant events which occur as part of normal operation.

**Transitioning to Daylight Savings Time**

The STSMGR process has switched to daylight savings time. (Action Code: J)

**Transitioning to Standard Time**

The STSMGR process has switched to standard time. (Action Code: J)

**AGE request has been issued**

An AGE request has been issued. (Action Code: J)

**AGE -c request has been issued**

An AGE -c request has been issued. (Action Code: J)

**Closing ACDDN statistics interval file.**

Occurs when the storage parameters are updated. (Action Code: J)

**Closing LOB statistics interval file.**

Occurs when the storage parameters are updated. (Action Code: J)

**Closing Walkaway statistics interval file.**

Occurs when the storage parameters are updated. (Action Code: J)

**Database is no longer full. Records will now be saved**

The Database now has space to add new records. (Action Code: J)

**Opening ACDDN statistics interval file**

Occurs when the storage parameters are updated. (Action Code: J)

**Opening LOB statistics interval file.**

Occurs when the storage parameters are updated. (Action Code: J)

**Opening Walkaway statistics interval file.**

Occurs when the storage parameters are updated. (Action Code: J)

**Storing LOB data by group**

Occurs when data is changed from store by agent to store by group. (Action Code: J)

## CFGUTIL Messages

### Introduction

This section contains the error messages generated by the CFGUTIL subsystem of the CC MIS product. The error messages may contain [XX] and/or 'YYYY' which denote any numeric and/or string, respectively.

### Warning Messages

This section lists the warning messages that may be generated by the CFGUTIL process. These messages usually indicate an unusual condition that can be appropriately handled by the process, and which do not prevent the process from continuing execution.

#### **CUST\_OPTS table access failure (custID=xx; rc=xx).**

Error reading CUST\_OPTS database table. (Action Code: B)

#### **DBSTORAGE table access failure (rc = xxxx).**

Error reading DBSTORAGE database table. (Action Code: B)

#### **DBSTORAGE table not initialized for partition xx.**

DBSTORAGE database table not initialized properly for this partition. (Action Code: B)

#### **Error reading configuration data base.**

An error occurred trying to read from the configuration database. (Action Code: B)

#### **Error creating SWXIF socket.**

Error trying to communicate with the DMSLINK process. (Action Code: B)

#### **Cannot decrease size limit below disk required in storage calc (xxxx mb)**

Size limit must be greater than or equal to disk required in Storage Calculator. (Action Code: AI)

#### **Not enough space available.**

Not enough room on the disk for the partition. (Action Code: AI)

#### **Error getting partition runstate.**

Error determining the state of the partition. (Action Code: B)

#### **Error deleting LANCONNECTS entry for yyyy**

Error deleting database record in LANCONNECTS table. (Action Code: B)

#### **Error updating LANCONNECTS entry for yyyy**

Error updating database record in LANCONNECTS table. (Action Code: B)

#### **Error deleting printer entry.**

An error occurred while trying to delete the printer defined on the LAN client. (Action Code: B)

**Error from sigaction() while setting SIG\_IGN of SIGPIPE**

Error trying to set ignore option on SIGPIPE signal. (Action Code: B)

**Error locking lock file**

An error occurred trying to open the lock file. (Action Code: B)

**Error opening lock file**

An error occurred trying to open the lock file. (Action Code: B)

**Error reading ptn\_moving file**

An error occurred trying to determine if a partition is moving. (Action Code: B)

**Error updating configuration database.**

An error occurred trying to update the configuration database. (Action Code: B)

**Error adding partition.**

Error adding a partition to the system. (Action Code: B)

**Error changing mode of partition.**

Error changing the mode of a partition. (Action Code: B)

**Operation failed.**

An error occurred while trying to update the switch links. (Action Code: B)

**Unable to read customer options file.**

An error occurred trying to read the customer options file. (Action Code: B)

**Unable to open yyyy file.**

An error occurred trying to open the specified file. (Action Code: B)

**Unable to read yyyy file.**

An error occurred trying to read from the specified file. (Action Code: B)

**Error changing runstate for partition xxxx**

An error occurred changing the state of the specified partition. (Action Code: B)

**Error disabling all changes.**

An error occurred trying to disable changes to all partitions. (Action Code: B)

**Error enabling all changes.**

An error occurred trying to enable changes to all partitions

**Error getting runstate for partition xx**

An error occurred determining the state of the specified partition. (Action Code: B)



**Unable to get operation result from CfgMgr**

Unsuccessful in receiving a response from the Configuration Manager. (Action Code: B)

**Error getting partition runstate.**

An error occurred trying to determine the state of a partition. (Action Code: B)

**Error starting partition(s).**

An error occurred trying to start the partition. (Action Code: B)

**Error stopping partition(s).**

An error occurred trying to stop the partition. (Action Code: B)

**Operation successful.**

Operation requested was performed successfully. (Action Code: J)

**Operation failed.**

Operation requested failed. (Action Code: B)

**Changes disabled on a partition basis.**

Changes are disabled for a particular partition. (Action Code: J)

**Partitions in SETUP mode may not be started.**

Trying to start a partition in SETUP mode failed. (Action Code: AI)

**A SIMULATOR type link is required for this operation.**

Operation requires a simulator link. (Action Code: AI)

**A LIVE type link is required for this operation.**

Operation requires a live link. (Action Code: AI)

**Database access failure occurred.**

Error accessing database. (Action Code: B)

**An internal system error occurred.**

Internal system error. (Action Code: B)

**Partition ID out of valid range.**

An operation was requested for a partition ID that is out of range. (Action Code: B)

**No disk selected for this partition's data.**

The partition has no disk defined. (Action Code: AI)

**Database not properly initialized.**

The database is not properly initialized. (Action Code: B)

**A subpool name is required.**

A subpool name is required for the requested operation to be performed successfully. (Action Code: AI)

**A subpool password is required.**

A subpool password is required for the requested operation to be performed successfully. (Action Code: AI)

**The maximum number of live partitions are already running.**

Attempting to start a partition when the maximum number of live partitions are already running. (Action Code: B)

**Cannot start a partition that is not installed.**

Attempting to start a partition that is not properly configured in the database. (Action Code: B)

**Could not stop this running partition.**

Error trying to stop partition. (Action Code: B)

**MAPA could not start this partition.**

MAPA encountered an error trying to start specified partition. (Action Code: B)

*Fatal Error Messages*

Fatal error messages are generated by MPSA in response to conditions which prevent the process from continuing normal execution. This section lists these error messages.

**List error detected**

Internal storage error detected. (Action Code: B)

**Invalid arguments passed**

Invalid arguments were passed to the CFGUTIL program. (Action Code: B)

**Error calculating required storage.**

An error occurred while trying to calculate the required storage. (Action Code: B)

**Error changing storage parameters.**

An error occurred trying to update the configuration database. (Action Code: B)

## DMS Simulator Messages

### Introduction

This section contains the error messages generated by the DMS Simulator. Note that these messages will only appear when the CC MIS system is in Training mode.

The error messages may contain [XX] and/or 'YYYY' which denote any numeric and/or string, respectively.

### Warning Messages

This section lists the warning messages that may be generated by the DMS Simulator. These messages usually indicate an unusual condition that can be appropriately handled by the process, and which do not prevent the process from continuing execution.

#### **call\_q->length = xxxx**

Attempted to read first call in an empty queue. (Action Code: L)

#### **Directory number xxxxxxxxxx not found - call discarded**

Called number could not be found. (Action Code: L)

#### **Invalid position**

No matching position id found for the reassign position request. (Action Code: L)

#### **RO rejected by simulator**

Invalid RO received by DMSSIM. (Action Code: B)

#### **RO rejected by DSP**

This error message is sent any time the DSP rejects an RO. (Action Code: B)

#### **Unable to decode NOP message - HEX dump follows**

Unable to decode an incoming OPDU. (Action Code: B)

#### **Lost synchronization on input data stream**

Lost synchronization while reading OPDUs in input data stream. (Action Code: B)

#### **List Error: Appending NULL data**

Attempt made to append null data to doubly linked list. (Action Code: B)

#### **List Error: Appending linked data**

Attempt made to append previously linked data to doubly linked list. (Action Code: B)

#### **List Error: Inserting NULL data**

Attempt made to insert null data into doubly linked list. (Action Code: B)

**List Error: Inserting linked data**

Attempt made to insert previously linked data into doubly linked list. (Action Code: B)

**List Error: Deleting unlinked data**

Attempt made to delete previously linked data from doubly linked list. (Action Code: B)

**X.25 link went down**

Lost connection to X.25 link. (Action Code: L)

**Illegal message type xx**

DMSSIM received an unrecognized message. (Action Code: B)

**Invalid Argument Error: [xx]**

An OPDU was received of this type with code [xx]. (Action Code: B)

**OPDU: Invalid Argument Error: [xx]**

An OPDU was received of this type with code [xx]. (Action Code: B)

**Operation Sequence Error: [xx]**

An OPDU was received of this type with code [xx]. (Action Code: B)

**OPDU: Operation Sequence Error: [xx]**

An OPDU was received of this type with code [xx]. (Action Code: B)

**Application Resource Shortage Error: [xx]**

An OPDU was received of this type with code [xx]. (Action Code: B)

**OPDU: Application Resource Shortage Error: [xx]**

An OPDU was received of this type with code [xx]. (Action Code: B)

**System Problem Error: [xx]**

An OPDU was received of this type with code [xx]. (Action Code: B)

**OPDU: System Problem Error: [xx]**

An OPDU was received of this type with code [xx]. (Action Code: B)

**Command Error: Call Profile <yyyy> not found**  
**Command Error: Invalid Call Queue <xxxx>**  
**Command Error: Invalid Call Rate <xxxx>**  
**Command Error: Invalid Group ACDDN <yyyy>**  
**Command Error: Invalid VFG index <xxxx>**  
**Command Error: Invalid number of agents <xxxx>**  
**Command Error: Position ID <xxxx> out of range**  
**Command Error: Unknown Position ID <xxxx>**  
**Command Error: Unknown Position event <xxxx>**  
**Command Error Walk/LOB/Agent code <xxxx> out of range**  
**Error on application connection socket <xxxx>**  
**Illegal Command message type <xxxx>**  
**Illegal Control message type <xxxx>**  
**Illegal Loadmgmt message type <xxxx>**  
**Illegal Response message type <xxxx>**  
**Illegal message type <xxxx>**  
**LoadMGMT Error: Cannot reassign ACDDN <yyyy> to new subpool**  
**LoadMGMT Error: Invalid ACDDN <yyyy>**  
**LoadMGMT Error: Invalid ACDDN Line Priority <xxxx>**  
**LoadMGMT Error: Invalid ACDDN Trunk Priority <xxxx>**  
**LoadMGMT Error: Invalid ACDDN priority <xxxx>**  
**LoadMGMT Error: Invalid Active State <xxxx>**  
**LoadMGMT Error: Invalid Agent ID <xxxx>**  
**LoadMGMT Error: Invalid Agent ID range <xxxx> to <xxxx>**  
**LoadMGMT Error: Invalid Audio Index <xxxx>**  
**LoadMGMT Error: CIF Route <xxxx>**  
**LoadMGMT Error: Call Transfer Queue Size <xxxx>**  
**LoadMGMT Error: FIAudio group <xxxx>**  
**LoadMGMT Error: FOAudio group <xxxx>**  
**LoadMGMT Error: Invalid Feature**

CHG\_ACTIVATE

CHG\_DWRPTIME

CHG\_FIAUDIO\_GROUP

CHG\_FOAUDIO\_GROUP

CHG\_MSQSTYPE

CHG\_ORGANN

CHG\_TMDTHRTE

CHG\_TMDTHRTE\_TIME

LoadMGMT Error: Invalid Group ACDDN <xxxx>  
LoadMGMT Error: Invalid Number of Overflow Groups <xxxx>  
LoadMGMT Error: Invalid Line of Business Code <xxxx>  
LoadMGMT Error: Invalid MSQS Threshold type <xxxx>  
LoadMGMT Error: Invalid MSQS Threshold Value <xxxx>  
LoadMGMT Error: Invalid Threshold Sequence  
LoadMGMT Error: Invalid Maximum CQ Size <xxxx>  
LoadMGMT Error: Invalid Maximum Logical Queue Size <xxxx>  
LoadMGMT Error: Invalid Maximum Queue Threshold <xxxx>  
LoadMGMT Error: Invalid Maximum Wait <xxxx>  
LoadMGMT Error: Invalid NSAudio group <xxxx>  
LoadMGMT Error: Invalid Nite Service Route <xxxx>  
LoadMGMT Error: Invalid ORGANN value <xxxx>  
LoadMGMT Error: Invalid Overflow Group ACDDN <yyyy>  
LoadMGMT Error: Invalid Overflow Start value <xxxx>  
LoadMGMT Error: Invalid Overflow Type value <xxxx>  
LoadMGMT Error: Invalid Preference Weight Factor <xxxx>  
LoadMGMT Error: Invalid Priority Promotion time <xxxx>  
LoadMGMT Error: Invalid RI Factor <xxxx>  
LoadMGMT Error: Invalid Recorded Announcement <xxxx>  
LoadMGMT Error: Invalid Service value <xxxx>  
LoadMGMT Error: Invalid Subpool number <xxxx>  
LoadMGMT Error: Invalid Threshold Route <xxxx>  
LoadMGMT Error: Invalid Time Delay Overflow Threshold value <xxxx>  
LoadMGMT Error: Invalid Time Delay Threshold Route <xxxx>  
LoadMGMT Error: Invalid Time Delay Threshold Time <xxxx>  
LoadMGMT Error: Invalid Variable Wrap-up Time <xxxx>  
LoadMGMT Error: Invalid number of display digits <xxxx>  
LoadMGMT Error: Invalid position ID <xxxx>  
LoadMGMT Error: Invalid supervisor ID <xxxx>  
LoadMGMT Error: Invalid target ACDDN <yyyy>  
Socket <xxxx> Information block not found  
Illegal console message type <xx>  
Instance <yyyy>> is invalid or out of range [1.999]  
Unrecognized option <yyyy> in command line  
OPDU: Application Resource Shortage Error <xxxx>  
OPDU: Invalid Argument Error <xxxx>

**OPDU: Operation Sequence Error <xxxx>**  
**OPDU: System Problem Error <xxxx>**  
**X.25: Connect confirmation error on CIREF <xxxx.xxxx>**  
**X.25: Connect confirmation to <yyyy> on CIREF <xxxx.xxxx> ignored**  
**X.25: Connect request from <yyyy> on CIREF <xxxx.xxxx> ignored**  
**X.25: Data confirmation ignored**  
**X.25: Data received on undefined CIREF <xxxx.xxxx>**  
**X.25: Disconnect confirmation on CIREF <xxxx.xxxx> ignored**  
**X.25: Disconnect on CIREF <xxxx.xxxx> ignored**  
**X.25: Disconnect on CIREF <xxxx.xxxx> with cause <xxxx> and code <xxxx>**  
**X.25: Disconnect request error on CIREF <xxxx.xxxx>**  
**X.25: Interrupt type data confirmation**  
**X.25 Interrupt type data on CIREF <xxxx.xxxx>**  
**X.25: Local data transmit failure <xxxx> on CIREF <xxxx.xxxx>**  
**X.25: Reset confirmation**  
**X.25: Reset on CIREF <xxxx.xxxx> with cause <xxxx> and code <xxxx>**  
**X.25: Undefined X.25 event <xxxx>**  
**Illegal Command message type <xxxx> received from dmssim**  
**Illegal Control message type <xxxx> received from dmssim**  
**Illegal Error message <xxxx> received from dmssim**  
**Illegal Loadmgmt message type <xxxx> received from dmssim**  
**Illegal Response message type <xxxx> received from dmssim**  
**Illegal message type <xxxx> received from dmssim**  
**Unrecognized option <yyyy> in command line**  
**MSG Error; Already in use**  
**MSG Error: Bad Profile**  
**MSG Error: Bad Value**  
**MSG Error: Exec, Can not run new process**  
**MSG Error: Fork, Can not run new process**  
**MSG Error: Transfer failed**  
**MSG Error: Unknown Type**

-m megs must be in the range 1 to 100

-p port must be either 0 or 1

-u cpu must be in the range 2 to 5

Application Resource Shortage Error; xxxx



Invalid Argument Error: xxxx

Lost synchronization on output data stream

Operation Sequence Error: xxxx

RO rejected by sim

RO rejected by simtest, kind <xxxx> code <xxxx>

System Problem Error: xxxx

Unable to decode NOP message - Hex dump follows

Unrecognized option <yyyy> in command line

### *Fatal Error Messages*

Fatal error messages are generated by the DMS Simulator in response to conditions which prevent the process from continuing normal execution. This section lists these error messages. (Action Code: B)

#### **Unrecognized option <yyyy> in command line.**

An illegal command option was given to the program. (Action Code: B)

## WINSERVER Messages

### Introduction

This section contains error messages generated by the Windows Server Process of the CC MIS product. The CC MIS product runs on a Down Stream Processor, hence the error messages will *NOT APPEAR IN THE SWITCH LOG*.

This section lists only those messages which are unique to the Windows Server Process. Messages listed in STANDARD ERROR MESSAGES on page 1 may also be generated by this process.

### Warning Messages

This section lists the warning messages that may be generated by WINSERVER. These messages usually indicate an unusual condition that can be appropriately handled by the process, and which does not prevent the process from continuing execution.

#### Message checksum is invalid

A message was received with an invalid checksum. No action is required unless a large number of these errors are generated. In this case, the quality of the serial connections should be increased. (Action Code: L, Y)

#### Message length field is invalid

A message was received with a corrupted length field. No action is required unless a large number of these errors are generated. In this case, the quality of the serial connections should be increased. (Action Code: L, Y)

#### Received packet is too long

A packet was received that was greater than 4096 bytes in length. If the error occurs very infrequently, then it could be due to transmission errors, otherwise it indicates a design error. (Action Code: L)

#### Acknowledgment timeout - session terminated

An acknowledgment for a transmitted message has not been received within the acknowledgment timeout period. The Windows Server process is assuming that the link has been disconnected or the client process has terminated and is terminating the current session. This log indicates that the system is automatically logging a supervisor off. (Action Code: Y)

#### Poll timeout - session terminated

An acknowledgment for a periodic polling message has not been received within the poll timeout period. The Windows Server process is assuming that the link has been disconnected or the client process has terminated and is terminating the current session. This log indicates that the system is automatically logging a supervisor off. (Action Code: Y)

#### Unable to create print spooler

A print spooler could not be created to support the addition of a Windows-based local printer to the system. Previous error logs should provide additional information on the cause of the error. (Action Code: L, B)

#### Unable to delete print spooler

The print spooler associated with a Windows-based local printer could not be deleted from the system. Previous error logs should provide additional information on the cause of the error. (Action Code: L, B)

**Unable to start printer creation request**

A request to start the creation of a Windows-based local printer has failed. This error indicates a corrupt system or a software design error. (Action Code: B)

**Unable to start printer deletion request**

A request to start the deletion of a Windows-based local printer has failed. This error indicates a corrupt system or a software design error. (Action Code: B)

**Invalid file type found in preview file**

When the supervisor's preview report was opened for viewing, an invalid file type was found. This may indicate a corrupted file on disk. The next time this supervisor generates a preview report, the problem should disappear. (Action Code: B)

**Invalid packet type [xx] received**

A packet was received that contained an invalid packet type, where "xx" is the hexadecimal packet type code in error. If the error occurs very infrequently, then it could be due to transmission errors, otherwise it indicates that the version of the client software is incompatible with the host software. (Action Code: Y, Z)

**Database read request for unknown table: xx**

The Windows Server process received a database read request for a table that it does not recognize. This probably indicates that the client software version is newer than the host software version. (Action Code: Z, B)

**Database delete request for unknown table: xx**

The Windows Server process received a database delete request for a table that it does not recognize. This probably indicates that the client software version is newer than the host software version. (Action Code: Z, B)

**Database write request for unknown table: xx**

The Windows Server process received a database write request for a table that it does not recognize. This probably indicates that the client software version is newer than the host software version. (Action Code: Z, B)

**Unrecognized message (0xnxxx) received**

A message was received that is unrecognized. "xxxx" gives the hexadecimal message type code. This probably indicates that the client software version is newer than the host software version. (Action Code: Z, B)

**Invalid file ID [0xnxxx] in WIN\_XFER\_RQST**

A request to transfer a file to the PC has failed because the ID of the requested file is unknown. This probably indicates that the client software version is newer than the host software version. (Action Code: Z, B)

**Unable to send command to modem**

Winserver was unable to send a command to the modem. (Action Code:D)

**Unable to obtain SYSTEM database lock**

The process was unable to obtain a system database lock which is needed to update the database.

**Detail Position nxxx is unknown**

**Unable to determine product release number***Informational Messages*

The following messages do not actually indicate an error condition but are used as notification of significant events which occur as part of normal operation.

**yyyy has logged in.**

This message is logged whenever a supervisor logs in to the CC MIS system. The yyyy is replaced by the supervisor name. (Action Code: J)

**yyyy has logged out.**

This message is logged whenever a supervisor logs out of the CC MIS system. The yyyy is replaced by the supervisor name. (Action Code: J)

*Fatal Messages*

Fatal error messages are generated by WINSERV in response to conditions which prevent the process from continuing normal execution. This section lists these error messages.

**Invalid arguments passed**

Invalid parameters were specified on the command line that was used to start the winserv process. (Action Code: B)

**Invalid baud rate**

An invalid baud rate was specified on the command line. This error message is only possible in the debugging version of the software. (Action Code: B)

## *AGE Messages*

### *Introduction*

This section contains error messages generated by the Automatic Historical Data Compaction Process of the CC MIS product. The CC MIS product runs on a Down Stream Processor, hence the error messages will *NOT APPEAR IN THE SWITCH LOG*.

This section lists only those messages which are unique to the Automatic Historical Compaction Process. Messages listed in STANDARD ERROR MESSAGES on page 1 may also be generated by this process.

### *Warning Messages*

This section lists the warning messages that may be generated by AGE. These messages usually indicate an unusual condition that can be appropriately handled by the process, and which does not prevent the process from continuing execution.

#### **Could not remove ager signal file “yyyy”**

Age was unable to remove ager signal file. (Action Code: B)

#### **Could not reduce database size**

Age was unable to remove data to make more space. (Action Code: C)

#### **Can't read storage limits for yyyy yyyy**

An error was encountered when reading the config db. (Action Code: B)

#### **Could not create ager signal file “yyyy”**

Age was unable to create the ager signal file. (Action Code: B)

#### **Unable to lock HDB\_AGED database**

Cannot lock the AGED portion of the database. (Action Code: B)

### *Informational Messages*

The following messages do not actually indicate an error condition but are used as notification of significant events which occur as part of normal operation.

#### **Compacting LOB data in: yyyy**

This message is logged whenever the storage options are changed from store by agent, to store by group. (Action Code: J)

#### **Compacting LOB interval data in: yyyy**

This message is logged when the interval data is compacted at midnight. (Action Code: J)

The following log messages are generated when AGE has been updated to new storage parameters. (Action Code: J)

**ACDDN statistics disabled: Removing data files.**

**ACDDN statistics enabled.**

**LOB statistics disabled: Removing data files.**

**LOB statistics enabled: Storing by Agent.**

**LOB statistics enabled: Storing by Group.**

**LOB statistics enabled: no storing by group.**

**Walkaway statistics disabled: Removing data files.**

**Walkaway statistics enabled.**

### **Removing file yyyy**

A file was removed due to day limits or database size limits. (Action Code: J)

### *Fatal Messages*

Fatal error messages are generated by AGE in response to conditions which prevent the process from continuing normal execution. This section lists these error messages.

#### **Failure to initialize AGE.**

Age was unable to obtain a lock on the database. (Action Code: B)

#### **STOREPARMS table access failed (rc = xxxx)**

Errors were encountered when reading the config database. (Action Code: B)

## *BAR Messages*

### *Introduction*

This section contains error messages generated by the Backup and Restore Process of the CC MIS product. The CC MIS product runs on a Down Stream Processor, hence the error messages will *NOT APPEAR IN THE SWITCH LOG*.

This section lists only those messages which are unique to the Backup and Restore Process. Messages listed in STANDARD ERROR MESSAGES on page 1 may also be generated by this process.

### *Warning Messages*

This section lists the warning messages that may be generated by BAR. These messages usually indicate an unusual condition that can be appropriately handled by the process, and which does not prevent the process from continuing execution.

#### **Nightly backup failed: yyyy**

This message is logged whenever a restore is started through the maintenance Restore screen. (Action Code: J)

#### **Nightly backup failed**

This message is logged whenever the nightly backup fails after it has been successfully initialized. (Action Code: W)

#### **Ad hoc backup failed**

This message is logged whenever an ad hoc backup fails. (Action Code: W)

#### **Restore Failed**

This message is logged whenever a restore fails. (Action Code: AA)

#### **Error starting mis\_nite**

An error occurred invoking the nightly cleanup script. (Action Code: B)

#### **Get service status error: nn**

A request to MAPA for service status information returned an error. The error code is specified by the “nn” field. (Action Code: B)

#### **Service request for yyyy failed. Return value nn**

A request to MAPA to start the program “yyyy” failed. The return value is specified by the “nn” field. (Action Code: B)

#### **Terminating current nightly backup (timed out)**

The nightly backup timed out and was terminated. (Action Code: AF)

#### **Terminating current ad hoc backup (timed out)**

An ad hoc backup timed out and was terminated. (Action Code: AF)

**Terminating current restore (timed out)**

A restore timed out and was terminated. (Action Code: AG)

**Error creating utility element**

An error occurred initializing communication with a BARUTIL process. (Action Code: B)

**Error finding utility element**

An error occurred communicating with a BARUTIL process. (Action Code: B)

**Received message from unregistered utility**

An error occurred communicating with a BARUTIL process (Action Code: B)

**Received unsolicited reply**

An error occurred communicating with the BARMGR process. (Action Code: B)

*Informational Messages*

The following messages do not actually indicate an error condition but are used as notification of significant events which occur as part of normal operation.

**Ad hoc backup beginning**

This message is logged whenever an ad hoc backup is started through the maintenance Backup screen. (Action Code: J)

**Ad hoc backup completed**

This message is logged whenever an ad hoc backup completes. (Action Code: J)

**Nightly backup beginning**

This message is logged whenever the nightly automatic backup is started. (Action Code: J)

**Nightly backup completed**

This message is logged whenever the nightly automatic backup completes. (Action Code: J)

**Restore beginning**

This message is logged whenever a restore is started through the maintenance Restore screen. (Action Code: J)

**Restore completed**

This message is logged whenever a restore completes. (Action Code: J)

*Fatal Error Messages*

Fatal error messages are generated by the BAR process in response to conditions which prevent the process from continuing normal execution. This section lists these error messages.



**Error initializing utility list**

An error occurred initializing an internal list. (Action Code: B)

**Bad message from barmgr**

An error occurred communicating with the BARMGR process. (Action Code: B)

## *WALLBOARD Messages*

### *Introduction*

This section contains error messages generated by the Wallboard Process of the CC MIS product. The Wallboard process writes the messages to their 'Standard Error' device. The error messages may contain [XX] and/or 'YYYY' which denote any numeric and/or string, respectively.

This section lists only those messages which are unique to the Wallboard Process. Messages listed in STANDARD ERROR MESSAGES on page 1 may also be generated by this process.

### *Fatal Error Messages*

Fatal error messages are generated by a Wallboard process in response to conditions which prevent the process from continuing normal execution. This section lists these error messages.

#### **Invalid baud rate**

An invalid baud rate was specified on the command line. This error message is only possible in the debugging version of the software. (Action Code: B)

#### **invalid arguments passed**

Invalid parameters were specified on the command line that was used to start the wallboard process. (Action Code: B)

## *MAINT Messages*

### *Introduction*

This section contains error messages generated by the Maintenance process of the CC MIS product. The Maintenance process writes the messages to their 'Standard Error' device. The error messages may contain [XX] and/or 'YYYY' which denote any numeric and/or string, respectively.

This section lists only those messages which are unique to the Maintenance Process. Messages listed in STANDARD ERROR MESSAGES on page 1 may also be generated by this process.

### *Warning Messages*

This section lists the warning messages that may be generated by Maint. These messages usually indicate an unusual condition that can be appropriately handled by the process, and which does not prevent the process from continuing execution.

#### **Bad return code from cfg\_db\_next\_link\_def: xxxx**

A link is tagged as having trace file, yet it cannot be found. (Action Code: B)

#### **Partition outside range 0..xxxx**

A partition was detected that exceeds the number of current partitions. (Action Code: B)

#### **Error closing index file.**

Maint was unable to close the log index file. (Action Code: B)

#### **Error removing index file.**

Maint was unable to remove and initialize the log index file. (Action Code:)

#### **Unknown logger command: xxxx (data xxxx)**

An unknown command was sent to Maint's log controller. (Action Code:)

#### **Write to system log file returned an error xxxx times yesterday**

The Maint process writes to the system log yesterday, returned errors xxxx times. (Action Code:)

#### **Wrote to system log file xxxx times yesterday without a lock.**

The Maint process wrote to the system log file xxxx times yesterday without obtaining a lock. (Action Code:)

#### **Fragmented log record - file: yyyy**

The log file size is not a multiple of the error message size, the file is damaged. (Action Code:)

#### **Error reading next record offset - file: yyyy**

There was an error reading the next record in the log file. (Action Code:)

#### **Error reading current day offset - file: yyyy**

**Invalid next record offset - xxxx**

The next record in the log file is located at an invalid offset. (Action Code:)

**Invalid current day offset - xxxx****Invalid date in yyyy**

And invalid date was encountered. (Action Code:)

*Informational Messages*

The following messages do not actually indicate an error condition but are used as notification of significant events which occur as part of normal operation.

**Processed xxxx dynamic debug messages**

Maint processed xxxx dynamic debug messages. (Action Code: J)

**Stopped logging dynamic debug messages**

Maint stopped logging dynamic debug messages. (Action Code: J)

*Fatal Error Messages*

Fatal error messages are generated by a Maint process in response to conditions which prevent the process from continuing normal execution. This section lists these error messages.

**Invalid Group DN filter: yyyy**

An invalid group DN filter was specified on the command line. (Action Code: B)

**Invalid Position Id filter: yyyy**

An invalid position Id filter was specified on the command line. (Action Code: B)

**Invalid Agent Id filter: yyyy**

An invalid agent Id filter was specified on the command line. (Action Code: B)

**Unknown Option: yyyy**

An unknown option was specified on the command line. (Action Code: B)

**An output file must be specified.**

An output file must be specified. (Action Code: B)

**Position, agent, and group filtering are mutually exclusive**

Only one type of filtering may be specified. (Action Code: B)

**Size of translated file exceeds pre-determined size.**

The size of the link trace file has exceeded the maximum pre-determined size. (Action Code: B)

**Invalid option.**

An invalid option was specified on the command line to the dynamic debugging module. (Action Code: B)

**Missing argument**

The required number of arguments were not found in the command line of the dynamic debugging module. (Action Code: B)

**Too many arguments**

Too many arguments were sent to the dynamic debugging module. (Action Code: B)

**Unknown argument: yyyy**

An invalid argument was sent to the dynamic debugging module. (Action Code: B)

**System Run State must be specified**

The system run state must be sent to the dynamic debugging module. (Action Code: B)

**Missing error pipe argument (-e)**

The command line to the system log controller did not include the error pipe specification. (Action Code: B)

**Missing log command pipe argument (-c)**

The command line to the system log controller did not include the log command pipe specification. (Action Code: B)

**Missing log index file argument (-i)**

The command line to the system log controller did not include the log index argument. (Action Code: B)

**Missing log file argument (-l)**

The command line to the system log controller did not include the log file argument. (Action Code: B)

**File stat error - file: yyyy**

Maint was unable to determine the file size of the indicated file. (Action Code: B)

**Fatal error from get\_syslog\_info: xxxx**

Maint system log received a fatal error from get\_syslog\_info. (Action Code: B)

**Bad return code from get\_syslog\_info: xxxx**

A bad return code was received from get\_syslog\_info. (Action Code: B)

**Parent process has become "init".**

The parent process has been restarted. (Action Code: B)

**Invalid argument - yyyy**

An invalid argument was passwd to cfg\_if. (Action Code: B)

**Invalid option**

An invalid was passwd to cfg\_if. (Action Code: B)

**List error detected**

An element in a list was not found. (Action Code: B)

## *SCHEDULER Messages*

### *Introduction*

This section contains error messages generated by the SCHEDULER process of the CC MIS product. The Maintenance process writes the messages to their 'Standard Error' device. The error messages may contain [XX] and/or 'YYYY' which denote any numeric and/or string, respectively.

This section lists only those messages which are unique to the SCHEDULER Process. Messages listed in STANDARD ERROR MESSAGES on page 1 may also be generated by this process.

### *Warning Messages*

This section lists the warning messages that may be generated by Scheduler. These messages usually indicate an unusual condition that can be appropriately handled by the process, and which does not prevent the process from continuing execution.

#### **No response from CCLINK**

Scheduler timed out trying to run a change order. (Action Code: R)

### *Fatal Error Messages*

Fatal error messages are generated by the Scheduler process in response to conditions which prevent the process from continuing normal execution. This section lists these error messages.

#### **Pipe stat failure - pipe: yyyy**

Scheduler was unable to determine the status of the pipe. (Action Code: R)

## DDBSERV Messages

### Introduction

This section contains error messages generated by the Definitions Database Server Process of the CC MIS product. The CC MIS product runs on a Down Stream Processor, hence the error messages will *NOT APPEAR IN THE SWITCH LOG*.

This section lists only those messages which are unique to the Defintiions Database Server Process. Messages listed in STANDARD ERROR MESSAGES on page 1 may also be generated by this process.

### Warning Messages

This section lists the warning messages that may be generated by DDBSERV. These messages usually indicate an unusual condition that can be appropriately handled by the process, and which does not prevent the process from continuing execution.

#### **Current database changed during linear pass**

While enumerating the records in a particular database table, the database server detected a change in the current table. The enumeration function is aborted. (Action Code: B)

#### **Database delete failed -- table: xxxxx, key: yyyyy**

The database server was unable to delete the record whose key value is “yyyyy” from database table “xxxxx”. (Action Code: B)

#### **Database open error - database: xxxxx**

The database server was unable to open the database file specified by “xxxxx”. (Action Code: B)

#### **Database write access denied - database: xxxxx**

The database server attempted to perform a write operation on the read-only database file specified in “xxxxx”. (Action Code: B)

#### **Duplicate entry in dblimits file on line: xx**

A duplicate record limit entry was found on line “xx” in the database limits file. (Action Code: B)

#### **Invalid class specification in dblimits file on line: xx**

A record limit specification for an invalid record class was found on line “xx” in the database limits file. (Action Code: B)

#### **Invalid limit value in dblimits file on line: xx**

An invalid record limit value was found on line “xx” in the database limits file. (Action Code: B)

#### **Invalid record name - name: xxxxx**

A database operation was attempted on a record name that is unknown to the database server. The name of this record is given in the “xxxxx” field. (Action Code: B)



**Invalid table name - name: xxxxx**

A database operation was attempted on a table name that is unknown to the database server. The name of this table is given in the “xxxxx” field. (Action Code: B)

**Invalid table name in dblimits file on line: xx**

A limit specification for an unknown database table was found on line “xx” of the database limits file. (Action Code: B)

**Missing field in dblimits file on line: xx**

An incomplete limit specification was found on line “xx” of the database limits file. (Action Code: B)

**Too many languages selected**

The database server found that there were more than three languages enabled on the system. An excess languages have been automatically disabled. (Action Code: B)

**Unable to lock definitions database: xxxxx**

The database server was unable to get an exclusive lock on the definitions database for the reason indicated in the “xxxxx” field. (Action Code: B)

**Unrecognized database command received - type: xx**

The database server received an invalid message type from a client program. The invalid message type is given in the “xx” field. (Action Code: B)

*Fatal Error Messages*

Fatal error messages are generated by the Definitions Database Server process in response to conditions which prevent the process from continuing normal execution. This section lists these error messages.

**No Standard/Custom designation specified for table xx**

The database schema does not indicate either a standard or a custom component in the database for the table specified by “xx”. (Action Code: B)

**Unable to determine current language selections**

The database server failed to determine which languages are enabled in the system. (Action Code: A)

**Unable to determine supported languages**

The database server failed to determine what languages are supported on the system. (Action Code: A)



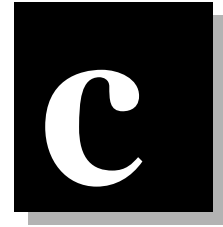

## Installing the operating system

Step C-1 provides instructions for installing the SVR4 operating system tape (NTOS 2.x) onto a Motorola VME 187 or 197 platform designated to be a CC MIS system. You should only have to perform this step once upon initially receiving your hardware or when upgrading from CC MIS Release 2.x to Release 3.x. Procedure C-2 is used to load the AIX platform.



If you are running NTOS 2.x and are installing or reinstalling a NTOS 2.x, you should access the System Configuration screen and make a note of the following Network Parameters: Network Hostname, Network Address, Network Mask, and Default Gateway. This information will not be saved during the upgrade and will be required after the new OS is loaded. (If you are using NTOS 1.x, this information must be obtained from the network administrator.)

To load the operating system tape for 187 or 197 platform, perform the steps in Procedure C-1.

### Procedure C-1: Installing the SVR4 OS

1. Ensure that the system has been powered down (from the Run State Utilities menu).
2. Place the operating system tape in either the cartridge tape drive or DATs drive (as applicable) and close the tape drive latch.
3. Turn the Motorola VME system on by pushing the on/off switch located on the front panel.
4. The system will boot from the NTOS operating system tape. Wait for the system to come up. The information displayed when the system comes up is dependent on the hardware in use (for example, MVME187 or MVME197). The prompts you see on your screen should be similar to the following:

**Copyright Motorola Inc. 1988 - 1992,  
All Rights Reserved**

**MVME187 Debugger Diagnostics Release Version 1.4 - 07/21/92  
COLD Start  
Local Memory Found = 02000000 (&33554432)  
MPU Clock Speed = 25 Mhz**

Note: The MPU Clock Speed depends on the processor in use.

Continued on next page ...

## Installing SVR4 OS - continued

5. Once the "MPU Clock Speed" message has appeared, press the Break key to interrupt the system diagnostics checking. After you have pressed the Break key, the system displays the message System Break key detected. The following menu should appear:

```
1. Continue System Start Up
2. Select Alternate Boot Device
3. Go to System Debugger
4. Initiate Service Call
5. Display System Test Errors
6. Dump Memory to Tape
Enter Menu #:
```

If you fail to interrupt the boot sequence, the system will boot anyway but it will boot from disk so you won't be able to go to step 5. This will take approximately 5 minutes longer.

6. At the menu, select option 3. Go to System Debugger. The following prompt displays:

```
187 - Bug>
```

7. Enter the following at the 187 - Bug> prompt:

```
>bo 0 40 COREunix (for cartridge drive)
      - OR -
>bo 0 50 COREunix (for DAT drive)
```

8. A message similar to the following is displayed next (depending on drive), then the system boots from the operating systems tape.

```
Booting from: VME187, Controller 0, Drive 40
Loading: COREunix
```

9. The system continues to boot. When the custom installation begins, the following messages display:

```
Custom UNIX SYSTEM V/88 Release 4 Version 4.3 for CC MIS
Base O/S Version      : FH40.43 RM04 P007
Customization Version : NTOS 2.x
```

### INSTALLATION & MAINTENANCE SYSTEM

```
***> Creating device nodes . . .
```

10. After the messages in step 8 appear, the following prompt displays:

### OPTIONS FOR PROCEEDING

```
=====
```

The following commands are available:

```
i - Install the operating system
c - Change processor type of installed system
m - Enter a maintenance shell
---> Enter your selection [i]:
```

Continued on next page ...

## Installing SVR4 OS - continued

11. Press the <Return> key at the prompt. This selects the default (i - install the operating system) and the installation will continue.

The system scans for, and displays, a list of installed hard disks (as shown in the example message below). The system then pauses until the <Return> key is pressed.

Proceeding with operating system installation . . .

**\*\*\*> Scanning system for installed hard drives . . .**

**INSTALL has determined that this system has both a CARTRIDGE and a DAT tape drive. You must select the tape drive which contains the O/S installation tape as follows:**

**c - Selects the CARTRIDGE tape**

**d - Selects the DAT tape drive**

**---> Which tape drive contains the O/S tape?**

Note: This prompt concerning tape drives only appears if there is both a CARTRIDGE and DAT tape drive in the system. If there is only one tape device, the prompt will not be displayed (no selection entry is required for step 11) and the messages in step 12 are displayed.

12. Type c to select CARTRIDGE device or type d to select DAT drive.

13. Regardless of the entry in step 11, the install program continues with the following messages:

**INSTALL has identified the following disks in this system:**

Disk	Size	Formatted	Description
----	----	-----	-----
m187_c0d0	1005MB	yes	SEAGATE ST11200N
m187_c0d1	1005MB	yes	SEAGATE ST11200N

**Press RETURN to continue**

Note: Disks and disk sizes vary depending on system hardware configuration.

14. Press the <Return> key. The installation then displays the options available (opsys, data, and skip) for processing the installed disks.

15. After displaying the available options, the installation prompts for the operation to be performed on each installed disk.

**Disk m187\_c0d0: 1005MB, SEAGATE ST11200N**

-----

**---> Enter setup option for disk m187\_c0d0 [opsys]:**

Continued on next page ...

## Installing SVR4 OS - continued

16. Press the <Return> key if the default in the brackets is correct. Otherwise enter the correct operation. If the installation detects that the disk may have already been formatted, the following prompt displays:

**This disk appears to be formatted. However, unless it was formatted under UNIX SVR4 the installation will fail if you choose not to format the disk. If you are sure that this disk has been formatted under SVR4, you can choose to skip formatting the disk to save time.**

-->Do you wish to format this disk? [yes]:

Note: If you are upgrading from NTOS 1.x to NTOS 2.x you must reformat each disk. You will be prompted to format each disk in your system.

17. Press the <Return> key to format the disk. Otherwise enter no to skip the formatting.

Note: If this disk was not formatted under SVR4 and it is not formatted in this step, the installation will fail.

18. Repeat steps 13 and 14 for each installed disk. When the selection is completed, the installation displays a list of all installed disks and the selected setup options.

19. After the list of disks and setup options, the installation displays the following prompt:

-->Are these disk setup options correct? [ ]:

20. If the setup options are not correct, enter no. The Installation then repeats the disk setup.

If the setup options are correct, enter yes. The installation displays the following prompt:

**Press RETURN to begin the installation**

21. Press the <Return> key to continue the installation. The installation is completed in four phases. Each phase displays progress messages to the screen.

Phase 1 checks the version of the installation tape.

Phase 2 installs the disks as specified during disk setup.

Phase 3 installs the operating system.

Phase 4 customizes the installation. During this phase, the installation provides information on setting the timezone, including a list of acceptable timezone values, then prompts for the timezone to be used in this system. Enter one of these values at the prompt:

--> Please enter the timezone for this system [4] :

Continued on next page ...

## Installing SVR4 OS - continued

22. Enter the correct timezone or press the <Return> key to use the default.

**\*\*\*>Setting date and time**

**---> Is the date and time "Thurs Dec 22 13:35:47 CST 1994" correct? [yes] :**

23. If the date and time are correct, press the <Return> key. If it is incorrect, enter no at the prompt. The installation then prompts for the correct date and time.

After the date and time have been entered, the installation prompts for the root password:

**\*\*\*> Setting root's password entry**

**New password:**

24. Enter a password for root. The system prompts for the password again to ensure that it was entered correctly. It is very important that a password for root be specified.

Note: Passwords are case sensitive: CCROOT and ccroot are considered two different passwords.

25. The installation prompts for a host name after the root password has been selected.

**\*\*\*>Setting host name**

**If you know the host name to be given to this system you can enter it now. Otherwise, just press RETURN to keep the default.**

**---> Enter the host name [ccmis] :**

26. Enter the system's host name (if known) or press the <Return> key to use the default.

The installation prompts for the system's IP address.

**\*\*\*>Setting Internet IP address**

**If you know the Internet IP address to be given to this system you can enter it now. Otherwise, just press RETURN to keep the default.**

**---> Enter the Internet IP address :**

Note: IP addresses are site specific.

27. Enter the system's IP address (if known) or press the <Return> key to use the default.

Note: If the default is used in this step, the IP address and LAN information must be added later.

The installation is now completed.

28. After the Return key is pressed, the system reboots off the system disk, detects all of the installed hardware, and regenerates the system kernel.

29. The system automatically reboots again.

This section provides instructions for installing the AIX operating system from DAT tape onto a Motorola PowerPC system designated to be used for CC MIS. You should only have to perform this step once upon initially receiving your hardware.

Before you begin you will need the following items:

- DAT tape labelled "AIX 4.1 for CC MIS"

Also, make sure the console terminal is set to 7 bit controls mode.

To load the operating system tape for PowerPC platform, perform the steps in Procedure C-2.

## Procedure C-2: Installing the AIX OS

1. Ensure that the system is powered down.
2. Turn on power to the system by pushing the on/off switch located on the front panel and interrupt the boot sequence by pressing the escape key ( Ctrl-[ ) when you see the following prompts appear on the terminal:

**SelfTest/Boots about to Begin... Press <BREAK> at anytime to Abort ALL**

**AutoBoot about to Begin... Press <ESC> to Bypass, <SPC> to Continue**

Once interrupted the "bug" prompt should appear:

**PPC1-Bug>**

3. Insert the AIX Operating System installation tape into the DAT tape drive.
4. Determine the address of the DAT tape drive by issuing the IOI command at the bug prompt. Output similar to that shown below should appear:

**PPC1-Bug>ioi**

**I/O Inquiry Status:**

```
CLUN DLUN CNTRL-TYPE DADDR DTYPE RM Inquiry-Data
0 0 NCR53C825 0 $00 N SEAGATE ST11200M ST31230 0660
0 10 NCR53C825 1 $00 N SEAGATE ST11200M ST31230 0660
0 50 NCR53C825 5 $01 Y ARCHIVE Python 28388-XXX 4.AH
1 0 PC8477 0 $00 Y <None>
```

**PPC1-Bug>**

The address of the tape drive is the value in the "DLUN" field for the line containing the description of the "ARCHIVE Python" tape drive. In the above example the address of the tape drive is determined to be "50".

Continued on next page ...



## Installing the AIX OS - continued

5. Enter the following command to boot from the tape (substitute the address determined in step 4 for the <addr> parameter):

```
pboot 0 <addr> (eg. pboot 0 50)
```

Occasionally the "pboot" command will fail if the tape is not yet ready to be read. In this case, wait a few seconds and try the command again.

6. Once the boot command has been issued the following should appear on the terminal:

```
Booting from: NCR53C825, Controller 0. Drive 50  
Device Name : /pci@80000000/pci1000,3@c,0/tape@5,0  
Loading: Operating System  
IPL Loaded at: $03C51000  
Residual-Data Located at: $03F7F000
```

A delay of approximately 90 seconds occurs at this point while the system boots a minimal operating system in order to begin the installation. Eventually, the following screen will appear:

```
***** Please define the System Console. *****  
  
Type a 1 and press Enter to use this terminal as the  
system console.  
Typ een 1 en druk op Enter om deze terminal als de  
systeemconsole to gebruiken.  
Skriv tallet 1 og trykk paa Enter for aa bruke denne  
terminalen som systemkonsoll.  
Pour definir ce terminal comme console systeme, appuyez  
sur 1 puis sur Entree.  
Taste 1 und anschliessend die Eingabetaste druecken, um  
diese Datenstation als Systemkonsole zu verwenden.  
Premere il tasto 1 ed Invio per usare questo terminal  
come console.  
Escriba 1 y pulse Intro para utilizar esta terminal como  
consola del sistema.  
Tryck paa 1 och sedan paa Enter om du vill att den haer  
terminalen ska vara systemkonsol.
```

Continued on next page ...

## Installing the AIX OS - continued

7. Press "1" and the <Enter><sup>1</sup> key at the prompt. Note that the number "1" is not echoed on the terminal. The system pauses for a while before the next screen (shown below) appears.

```
>>> 1 Type 1 and press Enter to have English during install.

88 Help ?

>>> Choice [1]: █
```

8. Press the <Enter> key to continue the installation in English. The following screen should appear:

```
                Welcome to Base Operating System
                Installation and Maintenance

Type the number of your choice and press Enter. Choice is indicated by >>>.

>>> 1 Start Install Now with Default Settings
    2 Change/Show Installation Settings and Install
    3 Start Maintenance Mode for System Recovery

88 Help ?
99 Previous Menu

>>> Choice [1]: █
```

---

<sup>1</sup>. The <Enter> and <Return> keys perform the same function; either may be used.

Continued on next page ...

## Installing the AIX OS - continued

9. Press the <Enter> key to continue the installation with the default settings. The following screen will appear, warning that all data on the system will be destroyed.

```

                                Installation Warning

WARNING: Base Operating System Installation may destroy or
impair recovery of data. Before installing, you should back up
your system.

>>> 1 Continue with Install

                                88 Help ?
                                99 Previous Menu

>>> Choice [1]:
```

10. Press the <Enter> key to begin the installation. The installation will display a progress screen (shown below) during the install. The entire installation process at this point will take from 18 to 20 minutes. When the installation completes the system will reboot from the hard disk. You will then be able to login to the system as the "root" user to begin the installation of the CC MIS software.

```

                                Installing Base Operating System

                                Please wait...

                                Approximate      Elapsed time
                                % tasks complete (in minutes)

                                16                0      Making logical volumes.
```



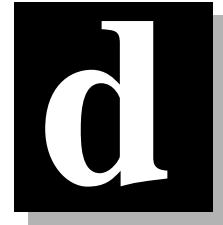

## Historical database

This appendix describes the database requirements for different entities within the historical database. The values shown in Table D-1 may be used to determine the database storage requirements for the historical database.

**Table D-1: Historical database tables**

Table	# of bytes	Record key
i_ovrflow	168	source group, destination group, day, interval
i_group	776	destination group, day, interval
i_agent	164	agent ID, supervisor ID, destination group, day, interval
i_lob	32	destination group, LOB code, day, interval, agent, subgroup
i_acddn	120	source ACD-DN, source group, day, interval
i_WALK	24	source group, day, interval, walk code
d_ovrflw w_ovrflw m_ovrflw	160	source group, destination group, day (or week or month)
d_group w_group m_group	768	destination group, day (or week or month)
d_agent	164	agent ID, supervisor ID, destination group, day (or week or month)
w_agent m_agent	164	agent ID, supervisor ID, destination group, week (or month)
d_lob w_lob m_lob	28	destination group, LOB code, interval, agent, subgroup

**Table D-1: Historical database tables**

Table	# of bytes	Record key
d_acddn w_acddn m_acddn	120	source ACD-DN, source group, day (or week or month)
d_WALK w_WALK m_WALK	24	source group, day (or week or month), walk code
l_agent	16	agent ID, event (login, logout, walkaway, return from walkaway), day, time

A record is stored in the database for each unique key as determined from Table D-1. For example, if an agent is moved to another supervisor within an interval, then two records exist for that agent ID within the interval since the two supervisor IDs cause two distinct keys (with all other portions of the key being identical).

A record only exists if there is data associated with the key. For example, if no calls are processed in a particular group within an interval, then no *i\_acddn* record will be stored in the database for that group in that interval. This means that during periods where there is no switch activity or link is down, no records are stored in the database. Reports generated will not contain data for this time period.

The database is pre-allocated using the database storage calculator. It is allocated with enough space to handle the storage parameters specified. Additionally, the database is compressed to maximize storage potential. The average compression ratio of 54% is reflected in storage calculator values.

The overhead for a boot disk is 350 Mbytes. The overhead per partition is 50 Mbytes.

The database storage calculator pre-allocates disk storage for historical data based on parameters supplied in the storage calculator screen. The values in Table D-2 are determined and are referenced for computing disk storage requirements.

**Table D-2: Historical database values**

Value	Description
ACD_GROUPS	Number of ACD groups to store
SDNS	Number of primary and supplementary DNs to store
POSITIONS	Number of active positions
AGENTS	Number of agent IDs

Table D-2: Historical database values

Value	Description
AGENTS_EVENTS	Number of agent events (login, logout, walkaway) per day
AVG_LOBS_GROUP	Average number of LOB codes entered per group
AVG_WALKS_GROUP	Average number of Walkaway codes entered per group
POSITION_REASSIGNS_PERCENTAGE	Percent of active agent positions reassigned each day
DN_REASSIGNS_PERCENTAGE	Percent of Supplementary DNs reassigned each day
STORE_DN_STATS	Yes/No flag for storage of SDN statistics group (all or none)
STORE_LOB_STATS	Yes/No flag for storage of LOB statistics by agent (by group, by agent, or none)
STORE_WALK_STATS	Yes/No flag for storage of Walkaway statistics (all or none)
SHIFTS	Number of shifts in a day
HOURS_PER_DAY	Number of hours per day
DAYS_PER_WEEK	Number of days per week
KEEP_INTERVAL	Number of days to keep interval data
KEEP_DAILY	Number of days to keep daily data
KEEP_WEEKLY	Number of weeks to keep weekly data
KEEP_MONTHLY	Number of weeks to keep monthly data
KEEP_LOG_EVENTS	Number of days to keep agent log event data
SRC_DEST_INTERFLOW_FACTOR	Expected number of source/destination group combinations
DISK_OVERHEAD	Disk overhead for operating system, application software temporary storage for reports, etc.

## Historical database equations

The historical database storage is computed as follows:

$$\text{Agt\_Grp\_Spv\_Interval} = \text{POSITIONS} \times \left( 1 + \frac{\text{POSITION\_REASSIGNS\_PERCENTAGE}}{100} \right)$$

$$\text{Agt\_Grp\_Spv\_Day} = \text{Agt\_Grp\_Spv\_Interval} \times \text{SHIFTS}$$

$$\text{Src\_Dest\_Grps\_Interval} = \text{ACD\_GROUPS} \times \text{SRC\_DST\_INTERFLOW\_FACTOR}$$

$$\text{Src\_Dest\_Grps\_Day} = \text{Src\_Dest\_Grps\_Interval} \times 1.6$$

If STORE\_LOB\_STATS = 'Agent'

$$\text{LOB\_Grp\_Interval} = \text{Agt\_Grp\_Spv\_Interval} \times \text{AVG\_LOBS\_GROUP}$$

$$\text{LOB\_Grp\_Day} = \text{AVG\_LOBS\_GROUP} \times \text{Agt\_Grp\_Spv\_Day} \times \frac{5}{3}$$

else If STORE\_LOB\_STATS = 'GROUP'

$$\text{LOB\_Grp\_Interval} = \text{ACD\_GROUPS} \times \text{AVG\_LOBS\_GROUP}$$

$$\text{LOB\_Grp\_Day} = \text{LOB\_Grp\_Interval} \times \frac{5}{3}$$

else

$$\text{LOB\_Grp\_Interval} = 0$$

$$\text{LOB\_Grp\_Day} = 0$$

If STORE\_WALK\_STATS = 'Agent'

$$\text{Walk\_grp\_interval} = \text{Agt\_grp\_spv\_interval} \times \text{AVG\_WALKS\_GROUP}$$

$$\text{Walk\_grp\_day} = \text{AVG\_WALKS\_GROUP} \times \text{Agt\_grp\_spv\_day} \times \frac{5}{3}$$

If STORE\_WALK\_STATS = 'Group'

$$\text{Walk\_grp\_interval} = \text{ACD\_GROUPS} \times \text{AVG\_WALKS\_GROUP}$$

$$\text{Walk\_grp\_day} = \text{Walk\_grp\_interval} \times \frac{5}{3}$$

else



$$\text{Walk\_grp\_interval} = 0$$

$$\text{Walk\_grp\_day} = 0$$

$$\text{Intervals\_Day} = \text{HOURS\_PER\_DAY} \times 2$$

$$\text{Days\_of\_Int\_Data} = ((\text{KEEP\_INTERVAL} \div 7) \times \text{DAYS\_PER\_WEEK} + (\text{KEEP\_INTERVAL} \bmod 7))$$

$$\text{Intervals\_to\_Store} = \text{Days\_of\_Int\_Data} \times \text{Intervals\_Day}$$

$$\text{Days\_to\_Store} = ((\text{KEEP\_DAILY} \div 7) \times \text{DAYS\_PER\_WEEK} + (\text{KEEP\_DAILY} \bmod 7))$$

$$\text{Num\_i\_ovrflw} = \text{Src\_Dest\_Grps\_Interval} \times \text{Intervals\_to\_Store}$$

$$\text{Num\_i\_group} = \text{ACD\_GROUPS} \times \text{Intervals\_to\_Store}$$

$$\text{Num\_i\_agent} = \text{Agt\_Grp\_Spv\_Interval} \times \text{Intervals\_to\_Store}$$

$$\text{Num\_i\_lob} = \text{LOB\_Grp\_Interval} \times \text{Intervals\_to\_Store}$$

if STORE\_DN\_STATS = 'GROUP'

$$\text{Num\_sdn\_interval} = (\text{ACD\_GROUPS} + (\text{DNS} \times \text{DN\_REASSIGNS\_PERCENTAGE} / \text{Interval\_Day})) \times \text{Intervals\_Day}$$

$$\text{Num\_sdn\_day} = \text{ACD\_GROUPS} + (\text{DNS} \times \text{DN\_REASSIGNS\_PERCENTAGE})$$

else if STORE\_DN\_STATS = 'AGENT'

$$\text{Num\_sdn\_interval} = (\text{ACD\_GROUPS} + (\text{DNS} \times \text{DN\_REASSIGNS\_PERCENTAGE} / \text{Interval\_Day})) \times \text{Intervals\_Day} \times \text{Agt\_Grp\_Spv\_Interval} / \text{ACD\_GROUPS}$$

$$\text{Num\_sdn\_day} = (\text{ACD\_GROUPS} + (\text{DNS} \times \text{DN\_REASSIGNS\_PERCENTAGE})) \times \text{Agt\_Grp\_Spv\_Interval} / \text{ACD\_GROUPS}$$

else

$$\text{Num\_sdn\_interval} = 0$$

$$\text{Num\_sdn\_day} = 0$$

$$\text{Num\_i\_acddn} = \text{Num\_sdn\_interval} \times \text{Days\_of\_Int\_Data}$$

$$\text{Num\_i\_walk} = \text{Walk\_Grp} \times \text{Intervals\_to\_Store}$$

$$\text{Num\_d\_ovrflw} = \text{Src\_Dest\_Grps\_Day} \times \text{Days\_to\_Store}$$

$$\text{Num\_d\_group} = \text{ACD\_GROUPS} \times \text{Days\_to\_Store}$$

$$\text{Num\_d\_agent} = \text{Agt\_Grps\_Spv\_Day} \times \text{Days\_to\_Store}$$

*Historical database*

$$\text{Num\_d\_lob} = \text{LOB\_Grp\_Day} \times \text{Days\_to\_Store}$$

$$\text{Num\_d\_acddn} = \text{Num\_sdn\_day} \times \text{Days\_to\_Store}$$

$$\text{Num\_d\_walk} = \text{Walk\_Grp} \times \text{Days\_to\_Store}$$

$$\text{Num\_w\_ovrflw} = \text{Src\_Dest\_Grps\_Day} \times \text{KEEP\_WEEKLY}$$

$$\text{Num\_w\_group} = \text{ACD\_GROUPS} \times \text{KEEP\_WEEKLY}$$

$$\text{Num\_w\_agent} = \text{Agt\_Grps\_Spv\_Day} \times \text{KEEP\_WEEKLY}$$

$$\text{Num\_w\_lob} = \text{LOB\_Grp\_Day} \times \text{KEEP\_WEEKLY}$$

$$\text{Num\_w\_acddn} = \text{Num\_sdn\_day} \times \text{KEEP\_WEEKLY}$$

$$\text{Num\_w\_walk} = \text{Walk\_Grp} \times \text{KEEP\_WEEKLY}$$

$$\text{Num\_m\_ovrflw} = \text{Src\_Dest\_Grps\_Day} \times \text{KEEP\_MONTHLY}$$

$$\text{Num\_m\_group} = \text{ACD\_GROUPS} \times \text{KEEP\_MONTHLY}$$

$$\text{Num\_m\_agent} = \text{Agt\_Grps\_Spv\_Day} \times \text{KEEP\_MONTHLY}$$

$$\text{Num\_m\_lob} = \text{LOB\_Grp\_Day} \times \text{KEEP\_MONTHLY}$$

$$\text{Num\_m\_acddn} = \text{Num\_sdn\_day} \times \text{KEEP\_MONTHLY}$$

$$\text{Num\_m\_walk} = \text{Walk\_Grp} \times \text{KEEP\_MONTHLY}$$

$$\text{Num\_d\_event} = \text{AGENT\_EVENTS} \times \text{AGENTS} \times \text{KEEP\_LOG\_EVENTS}$$

$$\begin{aligned} \text{Interval\_Storage} = & (\text{sizeof}(i\_ovrflw) \times \text{Num}_i\_ovrflw) + (\text{sizeof}(i\_group) \times \text{Num}_i\_group) + \\ & (\text{sizeof}(i\_agent) \times \text{Num}_i\_agent) + (\text{sizeof}(i\_lob) \times \text{Num}_i\_lob) + \\ & (\text{sizeof}(i\_acddn) \times \text{Num}_i\_acddn) + (\text{sizeof}(i\_walk) \times \text{Num}_i\_walk) \end{aligned}$$

$$\begin{aligned} \text{Daily\_Storage} = & (\text{sizeof}(d\_ovrflw) \times \text{Num}_d\_ovrflw) + (\text{sizeof}(d\_group) \times \text{Num}_d\_group) + \\ & (\text{sizeof}(d\_agent) \times \text{Num}_d\_agent) + (\text{sizeof}(d\_lob) \times \text{Num}_d\_lob) + \\ & (\text{sizeof}(d\_acddn) \times \text{Num}_d\_acddn) + (\text{sizeof}(d\_walk) \times \text{Num}_d\_walk) \end{aligned}$$

$$\begin{aligned} \text{Weekly\_Storage} = & (\text{sizeof}(w\_ovrflw) \times \text{Num}_w\_ovrflw) + (\text{sizeof}(w\_group) \times \text{Num}_w\_group) + \\ & (\text{sizeof}(w\_agent) \times \text{Num}_w\_agent) + (\text{sizeof}(w\_lob) \times \text{Num}_w\_lob) + \\ & (\text{sizeof}(w\_acddn) \times \text{Num}_w\_acddn) + (\text{sizeof}(w\_walk) \times \text{Num}_w\_walk) \end{aligned}$$

$$\begin{aligned} \text{Monthly\_Storage} = & (\text{sizeof}(m\_ovrflw) \times \text{Num}_m\_ovrflw) + (\text{sizeof}(m\_group) \times \text{Num}_m\_group) + \\ & (\text{sizeof}(m\_agent) \times \text{Num}_m\_agent) + (\text{sizeof}(m\_lob) \times \text{Num}_m\_lob) + \\ & (\text{sizeof}(m\_acddn) \times \text{Num}_m\_acddn) + (\text{sizeof}(m\_walk) \times \text{Num}_m\_walk) \end{aligned}$$

$$\text{Log\_Event\_Storage} = \text{sizeof(d\_event)} \times \text{AGENT\_EVENTS} \times \text{AGENTS} \times \text{KEEP\_LOG\_EVENTS}$$
$$\text{Data\_Storage} = \text{Interval\_Storage} + \text{Daily\_Storage} + \text{Weekly\_Storage} + \text{Monthly\_Storage} + \text{Log\_Event\_Storage}$$
$$\text{Disk\_Required\_by\_Partition} = \text{Data\_Storage} + \text{Partition\_Overhead}$$

The total space required for the partition is the resulting 'Disk\_Required\_by\_Partition' value from the above equation.



# System Configuration Reports

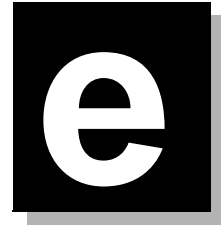

 Available system configuration reports

## Introduction

System configuration reports provide a record of system configuration changes and setup. The system configuration reports are accessed through the Maintenance interface by selecting the Reports option from the Configuration menu.

Figure E.1 Configuration menu

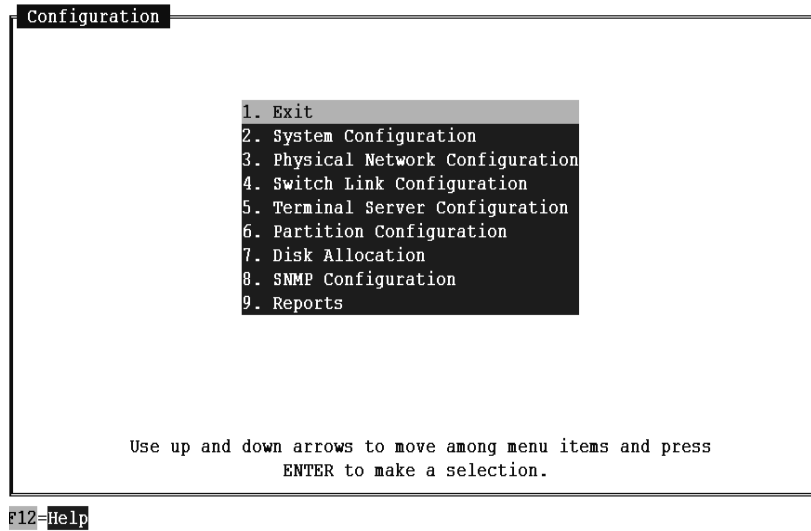

The following reports are available:

- System Configuration Report
- Port Allocation Report
- Switch Link Configuration Report
- Partition Configuration Report
- Disk Allocation Report
- Connection Parameters Report
- Partition Options Report
- Terminal Server Report
- Static LAN Terminal Configuration Report
- Serial Terminal Configuration Report
- Printer Configuration Report
- Wallboard Configuration Report
- Storage Parameters Report
- Simulator Configuration Report
- SNMP Configuration Report
- Interval Configuration Report
- Physical Network Configuration (Network)
- Virtual Network Configuration (Network)
- Master Privilege Definition
- Master Privilege Override
- All Reports



The SNMP report will not be available if the SNMP option has not been enabled for the system.

The Virtual Network Configuration and Physical network reports are available when the Networking option is enabled.

## System configuration report

This report provides information regarding the node name, IP address, and maintenance printer information.

If the node is a network node, the Network Name field is included in the report.



There must be a maintenance printer defined in order to print the system configuration reports. The maintenance printer can be connected to either a serial or parallel port of the VME. It is highly recommended that the maintenance printer be connected to the parallel port of the VME.

Figure E.2 System configuration report

### PowerPC platform

```

                                SYSTEM CONFIGURATION REPORT                                Page 1
East Region CC MIS                                                    Date: 09/31/94 Time: 10:25

System name:                    East Region CC MIS
** CC MIS Network Name:
LAN Parameters:
    Network Hostname:    carpycD0
    Network Address:    47.213.56.133
    Network Mask:       0xffffc00
    Default Gateway:    47.213.64.1

Maintenance Printer
    Unix Printer:
    Printer Model:
    Printer Name:
    
```

### 88K-based platform

```

                                SYSTEM CONFIGURATION REPORT                                Page 1
East Region CC MIS                                                    Date: 09/31/94 Time: 10:25

System name:                    East Region CC MIS
** CC MIS Network Name:
LAN Parameters:
    Network Hostname:    mishost
    Network Address:    47.213.56.133
    Network Mask:       0xffffc00
    Default Gateway:    47.213.64.1

Maintenance Printer
    Port:                contty02
    Mcdem:               No
    Baud Rate:           9600
    Printer Model:       HP RuggedWriter - 8.5
    Printer Name:        mispr11
    
```

### Port allocation report

This report provides information regarding the node ports, partition assignments, modem access, baud, and device type. This information was entered by means of the maintenance configuration screen for system configuration.

Figure E.3 Port allocation report

PORT ALLOCATION REPORT					Page 1
Spin			Date: 09/11/97 Time: 12:00:44		
PORT	PARTITION	MODEM	BAUD RATE	DEVICE TYPE	
console	System	No	9600	Console	
connty	System	Yes	9600	Dialup	
connty02	System	No	9600	System Use	
connty03		No	9600		
lp0	System			Printer	
m337_c0d0		No	9600		
m337_c0d1	Demi	No	9600	Wallboard - Daktronics	
m337_c0d2	Demi	No	9600	Supervisor Terminal	
m337_c0d3	S6	No	9600	Wallboard - Nortel	
m337_c0d4	SP1	No	9600	Wallboard - Daktronics	
m337_c0d5	Demi	No	9600	Wallboard - Daktronics	
RCS1-P0					
RCS1-P1	Demi			Supervisor Terminal	
RCS1-P2	Demi			Supervisor Terminal	
RCS1-P3	Demi			Supervisor Terminal	



### Switch link configuration report

This report provides information regarding the node's X.25 links, link types, X.121 address, pool assignments, passwords, and re-init time. This information was entered by means of the maintenance configuration screen for switch link configuration.

Figure E.4 Switch link configuration report

```

                                SWITCH LINK CONFIGURATION REPORT                                Page    1
Spin                               Date: 09/11/97      Time: 10:29:54
=====|
Link Number..... 2
Link Type..... Simulator
Enabled..... Yes

Simulator Configuration..... Small, overflow, 2 subpool (5Kcph)
=====

Link Number..... 4
Link Type..... Live X.25
Enabled..... Yes
ACD User ID..... SIMUSER
ACD User Password..... SIMUSER
ACD Pool Name..... SIMPOOL
ACD Pool Password..... SIMPOOL
Reinit Time.....
Synchronize to Switch Time..... No
Timezone Adjustment..... 0:00

X.121 Address..... 21212121

--- X.25 LINK CONFIGURATION PARAMETERS ---
Link      Port      Line Type      Clock      VC Type
-----
Primary..... MVME334A-0, Port 0      DTE (Modems)  EXT      Switched
=====

Link Number..... 1
Link Type..... Simulator
Enabled..... Yes

Simulator Configuration..... 8 mixed size subpools with overflow (5Kcph)

```

### Partition configuration report

This report provides information regarding the node's logical partitions, partition assignments, modes and current state. This information was entered by means of the maintenance configuration screen for partition configuration.

Figure E.5 Partition configuration report

---

PARTITION CONFIGURATION REPORT						Page	1
Spin		Date: 09/11/97		Time: 12:02:33			
PARTITION NAME	MODE	STATE	ID	DISK	SWITCH LINK NUMBER/TYPE/POOL		
SP1	Product	Stopped	1	1			
Jez	Training	Running	3	1	2/Simulator/ACDPOOL0		
NAP1	Product	Stopped	5	1	(NAP)		
Demi	Product	Running	2	1	(NAP)		
S6	Product	Running	6	1	4/Live /SIMPOOL		
S4	Product	Stopped	4	1	1/Simulator/ACDPOOL0		

---

### Disk allocation report

This report provides information regarding the system disk resources, partition allocations, and disk usage. This information was entered by means of the maintenance configuration screen for partition configuration.

Figure E.6 Disk allocation report

DISK ALLOCATION REPORT						Page 1
East Region CC MIS				Date: 09/31/94 Time: 10:25		
PARTITION NAME	SIZE LIMIT	SPACE IN USE	% IN USE	DISK NO.	% DISK ALLOC	
A-1 Airlines	147M	147M	79	1	14	
Acme Mortgage	128M	128M	93	2	12	
B & O Oil wells	85M	85M	94	2	8	
Smith's	120M	120M	70	2	11	
Smith's	480M	480M	83	3	42	
BankUSA	80M	80M	40	3	9	
US Financial	410M	410M	78	4	40	
Mail Orders	422M	422M	96	4	42	
Bill's	130M	102M	83	4	13	
Jims Toys						
DISK USAGE STATISTICS						
DISK NO.	MOUNT DIRECTORY	DISK SIZE	AVAIL SPACE	% FULL	NUM PARTITIONS	
1	/misdata/disk1	430M	43M	85	1	
2	/misdata/disk2	660M	156M	72	3	
3	/misdata/disk3	1044M	930M	12	2	
4	/misdata/disk4	1044M	875M	19	3	

### Connection parameters report

This report provides information regarding a partition's logical connection to a switch link pool, subpool (and their names), and password information. Only local partitions are listed since NAPs do not have switch connections. This information was entered by means of the maintenance configuration screen for partition configuration.

Figure E.7 Connection parameters report

---

CONNECTION PARAMETERS REPORT				Page	1
Spin		Date: 09/11/97	Time: 12:03:11		
	PARTITION	SWITCH LINK	ACD SUBPOOL	ACD SUBPOOL	
	NAME	ID	NUMBER/TYPE/POOL	NAME	PASSWORD
	SP1	1			
	Jez	3	2/Simulator/ACDPOOL0	ACDSP0	
	NAP1	5	(NAP Partition)		
	Demi	2	(NAP Partition)		
	S6	6	4/Live /SIMP00L	ACDSP0	ACDSP0
	S4	4	1/Simulator/ACDPOOL0	ACDSP0	

---

### Partition options report

This report provides information regarding a options that have been specified for a particular partition. This information was entered by means of the maintenance configuration screen for partition configuration.

Figure E.8 Partition options report

---

PARTITION OPTIONS REPORT		Page	1
Spin	Date: 09/11/97	Time: 10:38:59	
=====			
SP1			
Data Export	:	ENABLED	
Use of Maintenance Printer	:	ENABLED	
Nightly Backups	:	ENABLED	
Automatic Position Reassignment	:	ENABLED	
SNMP Support	:	ENABLED	
Flexible Intervals	:	DISABLED	
Maximum ACD Groups	:	64	
Maximum Positions	:	625	
Maximum Wallboard Ports	:	6	
Maximum Supervisor Connections	:	6	
Maximum Logins	:	6	
Dynamic LAN Terminal Access	:	ENABLED	
=====			
Jez			
Data Export	:	ENABLED	
Use of Maintenance Printer	:	ENABLED	
Nightly Backups	:	DISABLED	
Automatic Position Reassignment	:	ENABLED	
SNMP Support	:	ENABLED	
Flexible Intervals	:	DISABLED	
Maximum ACD Groups	:	50	
Maximum Positions	:	200	
Maximum Wallboard Ports	:	10	
Maximum Supervisor Connections	:	10	
Maximum Logins	:	10	
Dynamic LAN Terminal Access	:	ENABLED	
=====			
NAP1			
Data Export	:	ENABLED	
Use of Maintenance Printer	:	ENABLED	
Nightly Backups	:	ENABLED	
SNMP Support	:	ENABLED	
Flexible Intervals	:	ENABLED	
Maximum ACD Groups	:	1000	
Maximum Positions	:	1000	
Maximum Wallboard Ports	:	2	
Maximum Supervisor Connections	:	10	
Maximum Logins	:	10	
Dynamic LAN Terminal Access	:	ENABLED	

---

## Terminal server report

This report provides information regarding configured terminal servers. This information was entered by means of the maintenance configuration screen for terminal server configuration.

Figure E.9 Terminal server report

---

```
Page      1      TERMINAL SERVER CONFIGURATION REPORT
Spin                                           Date: 09/11/97   Time: 12:01:54

IP ADDRESS      NAME      BASE TCP PORT   #PORTS
47.81.160.176   RCS1      8000            16
```

---

### StaticLAN terminal report

This report provides information regarding static LAN ports (and their partition assignments), IP addresses and comments. This information was entered by means of the maintenance configuration screen for partition configuration.

Figure E.10 Static LAN terminals report

---

```
Static LAN TERMINALS REPORT                               Page 1
Spin                                                    Date: 09/11/97 Time: 10:41:56
=====
IP ADDRESS (OR RANGE)                                COMMENT
47.129.161.154-47.129.161.160                        Jez
47.129.161.179                                       Grelimin PC
```

---

## Serial terminal report

This report provides information regarding partition's serial ports (and their modem access), baud rate, and device type. This information was entered by means of the maintenance configuration screen for partition configuration.

Figure E.11 Serial terminal report

---

```

SERIAL TERMINAL CONFIGURATION REPORT
Page      1
Spin                               Date: 09/11/97   Time: 10:42:58
=====
SP1
  PORT          CONNECTIVITY    COMMENT
  m337_c0d30    DIRECT    9600      Test3forDemetria
=====
Jez
  PORT          CONNECTIVITY    COMMENT
  m337_c0d27    DIRECT    9600      twenty-seven
  m337_c0d28    DIRECT    9600      twenty-eight
  m337_c0d31    DIRECT    38400     test_serial_port_two
=====
NAP1
  PORT          CONNECTIVITY    COMMENT
=====
Demi
  PORT          CONNECTIVITY    COMMENT
  m337_c0d13    DIRECT    9600      Test2forDemetria
  m337_c0d22    DIRECT    9600      TestforDemetria
  RCS1-P1       TERM-SERVER
  RCS1-P2       TERM-SERVER
  RCS1-P3       TERM-SERVER
=====
S6
  PORT          CONNECTIVITY    COMMENT
=====
S4
  PORT          CONNECTIVITY    COMMENT
=====

```

---



### Printer configuration report

This report provides information regarding partition's printers (and their connectivity assignments) and device type. This information was entered by means of the maintenance configuration screen for partition configuration.

Figure E.12 Printer configuration report

---

```

                                PRINTER CONFIGURATION REPORT
                                Page      1
Spin                               Date: 09/11/97   Time: 10:44:05
=====
SP1
  INTERFACE      CONNECTIVITY  PRINTER MODEL  PRINTER NAME
  47.81.160.107  PC           Windows Printer  GRE-D2 ON SPIN
=====
Jez
  INTERFACE      CONNECTIVITY  PRINTER MODEL  PRINTER NAME
  47.129.161.149 PC           Windows Printer  Gregg's PC
  m337_c0d24     Direct 9600   HP LaserJet      Port test
=====
N&P1
  INTERFACE      CONNECTIVITY  PRINTER MODEL  PRINTER NAME
=====
Demi
  INTERFACE      CONNECTIVITY  PRINTER MODEL  PRINTER NAME
=====
S6
  INTERFACE      CONNECTIVITY  PRINTER MODEL  PRINTER NAME
=====
S4
  INTERFACE      CONNECTIVITY  PRINTER MODEL  PRINTER NAME
=====
```

---

## Wallboard configuration report

This report provides information regarding partition's wallboards (and their port assignments) and device information. This information was entered by means of the maintenance configuration screen for partition configuration.

Figure E.13 Wallboard configuration report

---

WALLBOARD CONFIGURATION REPORT Page 1

Date: 09/11/97 Time: 10:45:01

=====

SP1

PORT	CONNECTIVITY	MODEL	ADDRESS	NAME
m337_c0d15	DIRECT 9600	Daktronics	004343	Dak wallbd
m337_c0d20	MODEM 9600	Generic	1	Wallboard Gen

=====

Jez

PORT	CONNECTIVITY	MODEL	ADDRESS	NAME
m337_c0d26	DIRECT 9600	Nortel	22	RDJR_Cube_WB

=====

PORT	CONNECTIVITY	MODEL	ADDRESS	NAME
m337_c0d1	DIRECT 9600	Daktronics	111111	all ones
m337_c0d2	DIRECT 9600	Daktronics	222222	all twos
m337_c0d3	MODEM 9600	Daktronics	333333	all three's
m337_c0d4	DIRECT 9600	Daktronics	444444	all fours
m337_c0d5	DIRECT 9600	Daktronics	555555	all five's
m337_c0d6	DIRECT 9600	Daktronics	666666	all sixes
m337_c0d7	MODEM 9600	Daktronics	777777	all sevens
m337_c0d9	DIRECT 9600	Daktronics	888888	all eights
m337_c0d10	DIRECT 9600	Daktronics	999999	all nines

=====

---

## Storage parameters report

This report provides information regarding local partition's data storage sizing and durations. This information was entered by means of the maintenance configuration screen for partition configuration. (This report does not apply to NAPs.)

Figure E.14 Storage Parameters report

---

STORAGE PARAMETERS			
Spin	Date: 07/25/00	Time: 09:17:23	
Simulator Link			
SIZING PARAMETERS		STORAGE DURATION	
Number of ACD Groups .....	10	Interval data .....	7 DAYS
Avg source ACD-DNs/group .....	51	Daily data .....	30 DAYS
Avg active positions .....	200	Weekly data .....	22 WEEKS
Avg agents per day .....	200	Monthly data .....	12 MONTHS
Avg agent events/agent/day.....	32	Agent Event data .....	7 DAYS
Avg LOB codes/group.....	3	Agent Trace data .....	7 DAYS
Avg walk codes/group .....	3	HOURS OF OPERATION	
Avg source groups/dest groups..	3	Number of Shifts .....	3
Positions moves per day .....	2%	Days per week .....	7
ACD-DN reassigns per day .....	2%		
Disk space for Agent Trace.....	50MB		
OPTIONAL STATISTICS GROUPS		DISK SPACE	
Walkaway Statistics .....	By Agent	Disk Available .....	651 MB
ACD-DN Statistics .....	By Agent	Disk Limit .....	396 MB
LOBStatistics .....	By Agent	Disk Required .....	396 MB

---

### Interval Configuration Report

The Interval Configuration Report provides information which has been entered through the Interval Configuration screen through the Maintenance Interface. An example report follows:

Figure E.15 Interval configuration report

---

INTERVAL CONFIGURATION REPORT		Page 1	
Northern Telecom		Date: 12/20/96	Time: 09:45
=====			
Time	Interval Length	Time	Interval Length
-----			
00:00	No Data	12:00	15
01:00	No Data	13:00	15
02:00	No Data	14:00	15
03:00	No Data	15:00	15
04:00	No Data	16:00	15
05:00	60	17:00	30
06:00	60	18:00	30
07:00	60	19:00	30
08:00	15	20:00	30
09:00	15	21:00	30
10:00	15	22:00	30
11:00	15	23:00	30

---

### Simulator configuration report

This report provides information regarding simulator's subpools and their defined switch configurations. The information for this report is derived from the parameters supplied on the system tape for the simulator.

Figure E.16 Simulator configuration report

SIMULATOR CONFIGURATION REPORT		Page 1
East Region CC MIS		Date: 09/31/94 Time: 10:25
=====		
Simulator Configuration: 8 mixed size subpools overflow (5Kcph)		
Number of Subpools	8	
Number of ACD Groups:	60	
Number of Positions	5002	
Calls per hour:	50002	
=====		
Simulator Configuration: Small, overflow, 2 subpools (5Kcph)		
Number of Subpools	22	
Number of ACD Groups:	102	
Number of Positions	1002	
Calls per hour:	50002	
=====		

### SNMP configuration report

This report provides a hardcopy of the contents of the SNMP configuration screen.



The SNMP report will not be available if the SNMP option has not been enabled for the system.

Figure E.17 SNMP configuration report

SNMP CONFIGURATION REPORT		Page 1
System One		Date: 09/31/94 Time: 10:25
COMMUNITY NAME	COMMUNITY MEMBERS	
public	0.0.0.0	
secure	47.129.161.001 47.129.161.005	
traps	47.129.161.001	

## Physical network configuration report

This report provides a hardcopy of the contents of the physical network configuration screen.

Figure E.18 Physical network configuration report

---

PHYSICAL NETWORK CONFIGURATION REPORT			Page	1
Spin			Date: 09/11/97	Time: 10:53:37
PHYSICAL NODE NAME	NODE ID	ADDRESS		
Spin	0	47.81.160.105		
Power100	2	47.81.160.177		

---

## Virtual network configuration report

This report provides a hardcopy of the contents of the virtual network configuration screen.

Figure E.19 Virtual network configuration report

---

```

                                VIRTUAL NETWORK CONFIGURATION REPORT
                                Page      1

Spin                               Date: 09/11/97   Time: 10:54:48

=====
NAP1
PHYSICAL      NODE      LOCAL      PTN      PTN
NODE NAME     ID        PARTITION NAME  ID      CODE

Spin          0        DELETED          1      spn1

=====
Demi
PHYSICAL      NODE      LOCAL      PTN      PTN
NODE NAME     ID        PARTITION NAME  ID      CODE

Spin          0        DELETED          1      5th
    
```

---



### Master privilege Override report

This report provides a hardcopy of the contents of the master privilege override screen.

Figure E.20 Master Privilege Override report

---

MASTER PRIVILEGE OVER-RIDE REPORT			Page 1
Wilson			Date: 3/12/96 Time: 2:00
SUPERVISOR NAME	ID	MASTER OVER-RIDE?	
Mary Mathers	101	No	
Joe Jones	120	No	
Amy Adams	544	No	
Terry Technician	555	Yes	
Phillip Pham	852	No	

---

## Master privilege definition report

This report provides a hardcopy of the contents of the master privilege definition screen.

Figure E.21 Master Privilege Definition report

```

MASTER PRIVILEGE DEFINITION REPORT          Page    1
LINUX                                     Date: 01/15/02   Time: 14:48:46
-----
First
DISPLAY OPTIONS      CONFIG CONTROL OPTIONS      ADMINISTRATION OPTIONS
DISPLAYS            .YES      BASIC                .YES      SUPERVISORS/PRIORS .YES
PERSONAL FORMATS   .YES      POSITIONS REASSIGNM. .YES      SCOPES              .YES
PUBLIC FORMATS     .YES      AGENT SET PARAMS    .YES      DEFAULT COLORS     .YES
FORMULAS           .YES      QUEUE SIZES         .YES      TIME FRANGES      .YES
WALLBOARDS        .YES      TIME OVERFLOW       .YES      THRESHOLDS         .YES
GLOBAL VIEW        .YES      OVERFLOW TARGETS    .YES      ACD GROUPS         .YES
ADMINR              .YES      ANNOUNCEMENTS       .YES      ACD-DMS            .YES
ALANR               .NO*     SPECIAL ROUTING     .YES      AGENTS              .YES
REPORT OPTIONS
PERSONAL REPORTS   .YES      NETWORK PARAMS      .YES      WALKWAY CODES     .YES
PUBLIC REPORTS     .YES      ACT-ON REASSIGNS    .YES      JOB CODES          .YES
PERSONAL FORMATS   .YES      NETWORK TARGETS     .YES      SCHEDULES          .YES
PUBLIC FORMATS     .YES      CHANGE ORDERS       .YES      LISTS               .YES
FORMULAS           .YES      SUPERVISOR OPTIONS
SPECIMENS          .YES      PROFILE              .YES      DATA ACCESS OPTIONS
SYSTEM REPORTS     .YES      COLORS               .YES      AGENT IDENTITY     .YES
GLOBAL VIEW        .YES
ADMINR              .YES      AGENT PERFORMANCE   .YES
NOTE: Privileges listed as NO* are not available for this partition.
-----
Second
DISPLAY OPTIONS      CONFIG CONTROL OPTIONS      ADMINISTRATION OPTIONS
DISPLAYS            .YES      BASIC                .YES      SUPERVISORS/PRIORS .YES
PERSONAL FORMATS   .YES      POSITIONS REASSIGNM. .YES      SCOPES              .YES
PUBLIC FORMATS     .YES      AGENT SET PARAMS    .YES      DEFAULT COLORS     .YES
FORMULAS           .YES      QUEUE SIZES         .YES      TIME FRANGES      .YES
WALLBOARDS        .YES      TIME OVERFLOW       .YES      THRESHOLDS         .YES
GLOBAL VIEW        .YES      OVERFLOW TARGETS    .YES      ACD GROUPS         .YES
ADMINR              .YES      ANNOUNCEMENTS       .YES      ACD-DMS            .YES
ALANR               .YES      SPECIAL ROUTING     .YES      AGENTS              .YES
REPORT OPTIONS
PERSONAL REPORTS   .YES      NETWORK PARAMS      .YES      WALKWAY CODES     .YES
PUBLIC REPORTS     .YES      ACT-ON REASSIGNS    .YES      JOB CODES          .YES
PERSONAL FORMATS   .YES      NETWORK TARGETS     .YES      SCHEDULES          .YES
PUBLIC FORMATS     .YES      CHANGE ORDERS       .YES      LISTS               .YES
FORMULAS           .YES      SUPERVISOR OPTIONS
SPECIMENS          .YES      PROFILE              .YES      DATA ACCESS OPTIONS
SYSTEM REPORTS     .YES      COLORS               .YES      AGENT IDENTITY     .YES
GLOBAL VIEW        .YES
ADMINR              .YES      AGENT PERFORMANCE   .YES
NOTE: Privileges listed as NO* are not available for this partition.

```





---

# Index

---

## Numerics

3.x to 3.2 upgrades 11-1

## A

accessing online help 3-8  
ACD data link 1-8  
acronyms *intr-4*, *intr-5*  
add disk command (AIX) 13-2, 13-4  
adding a NAP 8-16  
adding a node to physical network 8-9  
adding a partition 7-5, 8-14  
adding a partition - network 8-14  
adding a printer 7-23  
adding a terminal server 6-12  
APR 7-8, 8-23  
assigning disks to a partition 7-13, 8-18  
automatic backup A-2  
automatic backups 5-5

## B

backing up customer data 5-4  
backup and restore menu 3-13, 5-1  
backup commands 5-6  
backup log 9-8  
backup screen 5-6

## C

cancelling a log printout 9-12

cancelling an X.25 check 9-39  
caution - new os required in 3.2 2-1  
CC MIS feature 1-1  
CC MIS network name 8-5  
CC MIS power down 4-5  
CC MIS shutdown 3-4, 4-1  
CC MIS startup 4-4  
CC MIS technical specifications A-1  
changing a printer definition 7-25  
changing a wallboard configuration 7-28  
changing data storage parameters 7-17  
changing port allocations 6-6  
changing the maint password 3-9  
changing time zone settings (AIX) 13-5  
checking an TCP/IP switch link 9-36  
checking an X.25 link 9-37  
checking filter on VME 8420 14-1  
configuration menu 3-12, 6-1  
configuration updates 10-1  
connection parameters 7-19  
connection parameters report E-8  
control commands 3-2  
conventions used in guide *intr-2*  
cpu utilization - system monitor 9-13  
cpu utilization status 9-23

## D

DAT tape drive 5-2  
DAT tapes 5-2  
data storage parameters 2-3  
data storage worksheet 2-2, 2-11

database D-1  
 dealing with power failures 4-7  
 debugging - link trace 9-27  
 default gateway 6-4, 8-5  
 deleting a NAP 8-16  
 deleting a node - physical networks 8-10  
 deleting a partition 7-6, 8-16  
 deleting LAN clients 7-30  
 diagnostic tools 9-1  
 direct printers 7-23  
 disabling an X.25 link 9-38  
 disk allocation 7-13  
 disk allocation report E-7  
 disk allocation screen parameters 7-14  
 display free disk space screen 9-3  
 DMS-ACD tables 1-8

**E**

enabling an X.25 link 9-38  
 error messages B-1  
 establishing a network 8-3  
 expired passwords 3-6

**F**

file transfer command 9-4  
 filter - message translation 9-28  
 free disk space 9-3  
 functions requiring shutdown 3-4

**H**

historical database D-1

**I**

I/O ports (testing) 9-2  
 initialize an X.25 link 9-39  
 install log 9-8  
 installation - preparing for 2-2  
 installing 4.0 2-1  
 installing 4.0 on VME host 2-10  
 installing new OS C-1  
 interflow parameters 2-5  
 interval configuration 7-18  
 interval lengths 7-18  
 intervals, issues concerning 7-18

**K**

key terms (networks) 8-2

**L**

LAN clients report E-11  
 LAN connected PC 7-23  
 LAN IP address 7-29  
 LAN terminals 7-29  
 link trace 9-27  
 list of system config reports 6-17  
 live link type 6-9  
 load new software version command 11-1  
 lock - partition monitor 9-13  
 lock status 9-17  
 log messages B-1  
 log printouts 9-12  
 logging into maint 3-5  
 logging out of maint 3-11  
 logs 9-8

**M**

maint login 3-5  
 maintenance console 1-2  
 maintenance log 9-8  
 maintenance menus 3-1  
 manual backups 5-5  
 menu map 3-3  
 message translation filter 9-28  
 MIB definitions 1-7, 6-14, 12-1  
 maintenance main menu 3-12  
 modem port 9-26  
 monitor command 9-11  
 mount directory 7-15  
 multiple partitions 7-1

**N**

NAPs 8-11, 8-14, 8-19  
 netmask 6-4, 8-5  
 network - key terms 8-2  
 network - overview 8-2  
 network - security 8-4  
 network - steps to establish 8-3  
 network - virtual 8-19  
 network access partitions (NAP) 8-14  
 network address 6-4, 8-5  
 network hostname 6-4, 8-5  
 network management systems (NMS) 12-1  
 Networked CC MIS 8-1  
 networking feature 8-1  
 networks - virtual 8-14  
 new systems (overview) 3-4  
 node name 8-5  
 NTOS 2.x C-1

## O

online help 3-8  
 operating system configuration (AIX) 13-1  
 order of installation for new system 2-2  
 overview of maint menus 3-3

## P

page down 3-2  
 page up 3-2  
 paging thru a screen 3-2  
 partition configuration commands 7-3  
 partition configuration report E-6  
 partition configuration screen 7-1  
 partition operating modes 7-2  
 partition options 7-5, 8-14  
 partition options report E-9  
 partition options screen 7-7, 8-22  
 partition shutdown 7-37  
 partition startup 7-37  
 partition status 9-19  
 partitions 7-1  
 partitions - local 8-11  
 partitions - NAPs 8-11  
 password change 3-9  
 password expiration prompt 3-6  
 PC attached printers 7-23  
 performing a configuration update 10-2  
 PF keys 3-2  
 PF keys in maint intr-3  
 physical network - adding nodes 8-9  
 physical network - deleting nodes 8-10  
 physical network configuration 8-7  
 physical network login 9-40  
 popup menus 3-2  
 port - system monitor 9-13  
 port allocation 6-6  
 port allocation report E-4  
 port configuration report E-12  
 port status 9-21  
 power down CC MIS 4-2, 4-5  
 power failures 4-7, A-2  
 precut mode 1-9  
 print translated link 9-28  
 printer configuration report E-13  
 printing a log 9-12  
 printing a translated trace 9-33  
 printing the link trace 9-33  
 privileges 7-31  
 product mode 1-9  
 program - system monitor 9-13

## R

re-calculating data storage parameters 2-11  
 reinit time field 6-9  
 re-initialization of link - config update 10-2  
 Release 3.1 enhancements 1-3, 1-6  
 Release 3.2 enhancements 1-7  
 removing a printer 7-26  
 requirements for a partition running state 7-3  
 resetting the modem port 9-26  
 restore log 9-8  
 restore screen 5-10  
 restoring customer data 5-9  
 run state utilities menu 3-14  
 running state (partition) 7-3

## S

screens 3-1  
 select different link command 9-28, 9-34  
 selecting a log 9-9  
 selecting menu items 3-1  
 serial terminals 7-21  
 setting up a new system 3-4  
 shutdown partitions 4-2  
 shutting down a partition 7-37  
 shutting down CC MIS 4-1  
 simulator configuration report E-17  
 simulator link type 6-10  
 size of systems 1-1  
 SNMP 1-7, 6-14, 7-8, 8-23  
 SNMP configuration report E-18, E-19, E-20, E-21, E-22  
 SNMP configuration screen 6-14  
 SNMP MIB transfers 12-1  
 SNMP transfer session 12-3  
 specifying master/supervisor privileges 7-31  
 starting a partition 7-37  
 starting CC MIS 4-4  
 startup partitions 4-2  
 storage calculator 7-16  
 storage parameters report E-15  
 supervisor terminals 1-2  
 SVR4 operating system C-1  
 switch link configuration 6-8  
 switch link configuration report E-5  
 system configuration reports 6-17, E-1, E-3  
 system configuration screen 6-3  
 system configuration screen - network 8-4  
 system configurations 1-1  
 system log 9-8  
 system monitor 9-13  
 system software upgrades 11-2

---

system upgrade utility menu 3-13

## T

tape rotation - VME 8420 14-2  
Terminal Servers 6-11  
test all I/O ports 9-2, 9-6  
test individual I/O port 9-2, 9-7  
Time Zone Adjustment command (AIX) 13-5  
training mode 1-9  
transfer session 12-3  
typographical conventions intr-2

## U

Unix OS version 2-1  
upgrade requirements 1-1  
upgrades from 3.1 (or later) or 4.0 to 4.x 11-1  
UPS A-2  
user interface screens 3-1  
using PF keys intr-3

## V

view system monitor 9-13  
view translated link 9-28  
viewing a link trace 9-30  
viewing a log 9-10  
viewing a translated link trace 9-31  
virtual network configuration 8-19  
virtual network definition 8-18  
virtual networks 8-15  
VME 8420 preventive maintenance 14-1

## W

wallboard configuration report E-14  
wallboards 7-27  
write-protecting DAT tapes 5-3

## X

X.25 diagnostics 9-37  
XR VME 1-2













**NORTEL NETWORKS CONFIDENTIAL:**

The information contained in this document is the property of Nortel Networks. Except as specifically authorized in writing by Nortel Networks, the holder of this document shall keep the information contained herein confidential and shall protect same in whole or in part from disclosure and dissemination to third parties and use same for evaluation, operation, and maintenance purposes only.

Information is subject to change without notice. Nortel Networks reserves the right to make changes in design or components as progress in engineering and manufacturing may warrant.

DMS and Meridian are trademarks of Nortel Networks. HP, HP RuggedWriter, and HP LaserJet are trademarks of Hewlett-Packard Corporation. GRAFSMAN is a trademark of Soft-tek International. Reflection 4+ is a trademark of Walker, Ritchie & Quinn, Inc. System V/88 and Veritas are trademarks of Motorola Corporation. Windows, Windows 95 & 98, and Windows NT are trademarks of the Microsoft Corporation. Other trademarks, product names, and servicemarks contained in this guide are property of their respective companies or owners.

